

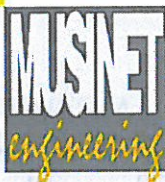

SOCIETA' ITALIANA
 TRAFORO AUTOSTRADALE DEL FREJUS
 Sede legale: fraz. San Giuliano, 2 - 10059 Susa (TO)



MUSNET ENGINEERING S.p.A.
 Cso Svizzera, 185
 10149 TORINO
 Tel. +39 011 5712411
 Fax. +39 011 5712426
 E-mail info@musinet.it
 PEC musinet@legalmail.it

Gruppo SITAF

P.I.Iva 08015410015
 Cap. Soc. E. 520.000 i.v.
 Cod. fis.e Reg. Imprese
 TO 08015410015
 R.E.A. Torino 939200

RILOCALIZZAZIONE DELL' AUTOPORTO DI SUSAS

SOVRAPPASSO DI INGRESSO - PONTE STRALLATO - RELAZIONE DI CALCOLO

Indice	Date/ Data	Modifications / Modifiche	Etabli par / Concepito da	Vérifié par / Controllato da	Autorisé par / Autorizzato da
0	07/09/2013	Première diffusion / Prima emissione	L.BARBERIS (MUSINET)	C.GIOVANNETTI (MUSINET)	M.BERTI (SITAF)
A	25/10/2013	Passage au statut AP / Passaggio allo stato AP	L.BARBERIS (MUSINET)	C.GIOVANNETTI (MUSINET)	M.BERTI (SITAF)

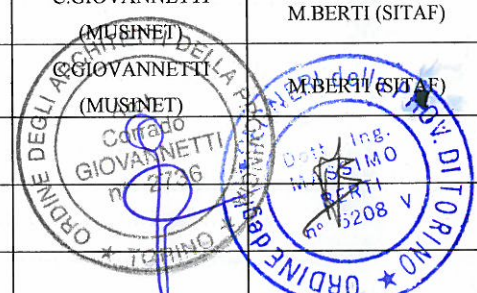

COD E DOC	P	D	2	C	3	A	M	U	S	1	5	0	2	A
	Phase / Fase		Sigle étude / Sigla		Émetteur / Emittente			Numero			Indice			

A	P	N	O	T
Statut / Stato		Type / Tipo		

ADRESSE GED INDIRIZZO GED	C3A	//	//	70	20	10	50	02
------------------------------	-----	----	----	----	----	----	----	----

ECHELLE / SCALA
-

CUP	C11J05000030001
-----	-----------------

SOMMAIRE / INDICE

1. PREMESSA	6
2. NORMATIVA DI RIFERIMENTO	6
3. DESCRIZIONE DELLE STRUTTURE	7
4. CARATTERISTICHE DEI MATERIALI	15
4.1 Conglomerato di classe di resistenza C35/45	15
4.2 Conglomerato di classe di resistenza C32/40	15
4.3 Conglomerato di classe di resistenza C28/35	16
4.4 Acciaio da c.a. tipo B450C saldabile	16
4.5 Acciaio armonico per stralli	16
4.6 Acciaio da carpenteria metallica S355 JO (Rif. UNI EN 10025-2)	16
4.7 Bulloni di classe 8.8 e dadi classe 8.0	17
4.8 Collegamenti in unioni saldate	17
5. AZIONI DI PROGETTO	18
5.1 Azioni gravitazionali	18
5.2 Azioni variabili da traffico	19
5.3 Azioni longitudinale di frenamento o di accelerazione	24
5.4 Azione centrifuga	25
5.5 Azione del vento e della neve	25
5.5.1 Vento a ponte scarico	26
5.5.2 Vento a ponte carico	26
5.5.3 Neve	26
5.6 Attrito ai vincoli	27
5.7 Urto di veicolo in svio	27
5.8 Ritiro e viscosità del calcestruzzo dell'antenna	27
5.9 Variazioni termiche	28
5.10 Pretensione stralli	29
5.11 Azioni sismiche	29
6. MODELLAZIONE DELLA STRUTTURA	38
6.1 Descrizione del modello di calcolo	38
7. AZIONI SULLE STRUTTURE	42
7.1 Condizioni elementari di carico	42
7.2 Combinazioni delle azioni agli Stati Limite	43
7.3 Studio delle fasi costruttive	50
8. VERIFICHE DELLE STRUTTURE IN ACCIAIO DI IMPALCATO	54
8.1 Premessa	54
8.2 Verifiche di resistenza delle membrature	54
9. VERIFICHE DELLA PILA, DELL'ANTENNA E DEGLI STRALLI	68
9.1 Premessa	68
9.2 Verifiche di resistenza della pila centrale	68
9.3 Verifiche di resistenza dell'antenna	71
9.4 Verifiche di resistenza degli stralli	80
10. VERIFICHE DI DEFORMAZIONE E REAZIONI AGLI APPOGGI	82

10.1	Verifica di deformazione impalcato	82
10.2	Reazioni agli appoggi	85
11.	ASPETTI GEOTECNICI E FONDAZIONI	87
11.1	Premessa	87
11.2	Caratterizzazione meccanica dei terreni	87
11.3	Criteri di analisi e verifica agli Stati Limite Ultimi	88
11.4	Verifiche di resistenza di tipo "GEO"	89
11.5	Verifiche di resistenza di tipo "STR"	94
12.	CONCLUSIONI	101
	INPUT DEL MODELLO DI CALCOLO	102
	OUTPUT DEL MODELLO DI CALCOLO	154

LISTE DES FIGURES / INDICE DELLE FIGURE

Figura 1	– Planimetria Sovrapasso di Ingresso	7
Figura 2	– Profilo longitudinale	8
Figura 3	– Sezione tipo corrente	9
Figura 4	– Sezione in corrispondenza del traverso di pila	10
Figura 5	– Schema appoggi	11
Figura 6	– Prospetto laterale pila centrale-antenna	12
Figura 7	– Vista assonometrica della pila-antenna	13
Figura 8	– Schema tipologico degli stralli e dettaglio trefolo	14
Figura 9	– Sovraccarichi permanenti G2	19
Figura 10	– Schemi di azioni variabili da traffico	20
Figura 11	– Moving load case Q1a	22
Figura 12	– Moving load case Q1b	22
Figura 13	– Posizione dei carichi mobile per la massimazione del momento flettente in campata	23
Figura 14	– Posizione dei carichi mobile per la massimazione del momento flettente sull'appoggio centrale	23
Figura 15	– Posizione dei carichi mobile per la massimazione del momento torcente sull'appoggio centrale	24
Figura 16	– Parametri adottati	27
Figura 17	– Andamento temporale delle deformazioni da ritiro	28
Figura 18	– Andamento temporale del coefficiente di viscosità	28
Figura 19	– Carichi di pretensione	29
Figura 20	– Vista 3D del modello di calcolo globale	39
Figura 21	– Prospetto frontale della pila-antenna	39
Figura 22	– Prospetto laterale della pila-antenna	40
Figura 23	– Sezione impalcato in acciaio	40
Figura 24	– Modello parziale piastra ortotropa superiore	41
Figura 25	– Modello parziale piastra ortotropa superiore: schema dei vincoli adottati	41
Figura 26	– Modello Fase 1	52
Figura 27	– Modello Fase 2	52
Figura 28	– Modello Fase 3	53
Figura 29	– Modello Fase 4	53

Figura 30 – Sforzo normale (SLU)	54
Figura 31 – Momento flettente asse y (SLU).....	55
Figura 32 – Momento flettente asse z (SLU).....	55
Figura 33 – Taglio asse z (SLU)	56
Figura 34 – Taglio asse y (SLU).....	56
Figura 35 – Torsione (SLU).....	57
Figura 36 – Fase 1: momenti flettenti asse y da peso proprio.....	57
Figura 37 – Fase 4: momenti flettenti asse y in seguito alla rimozione dei puntelli provvisori	58
Figura 38 – Fase 4: momenti flettenti asse y in seguito alla applicazione dei sovraccarichi permanenti e della pretensione degli stralli.....	58
Figura 39 – Fase 4: momenti flettenti asse y a lungo termine per valori finali del ritiro e della viscosità del calcestruzzo dell'antenna	59
Figura 40 – Tensioni normali massime (SLU).....	59
Figura 41 – Tensioni di taglio massime asse y (SLU)	60
Figura 42 – Tensioni di taglio massime asse z (SLU)	60
Figura 43 – Tensioni ideali (SLU) per la sezione in corrispondenza dell'appoggio centrale. 61	
Figura 44 – Tensioni ideali (SLU) per la sezione in campata.....	61
Figura 45 – Tensioni ideali (SLU) per la sezione in campata in corrispondenza dei fori di ispezione.....	62
Figura 46 – Tensioni ideali (SLU) della piastra sp.30mm	62
Figura 47 – Tensioni ideali (SLU) degli irrigidimenti della piastra sp.30mm.....	63
Figura 48 – Sforzo normale (SLU) del traverso intermedio (in basso) e del traverso dell'appoggio centrale (in alto)	63
Figura 49 – Momento flettente (SLU) del traverso intermedio (in basso) e del traverso dell'appoggio centrale (in alto)	64
Figura 50 – Taglio (SLU) del traverso intermedio (in basso) e del traverso dell'appoggio centrale (in alto)	64
Figura 51 – Tensioni normali massime (SLU) del traverso intermedio (in basso) e del traverso dell'appoggio centrale (in alto)	65
Figura 52 – Tensioni tangenziali massime (SLU) del traverso intermedio (in basso) e del traverso dell'appoggio centrale (in alto)	65
Figura 53 – Tensioni ideali (SLU) per la sezione in corrispondenza dell'appoggio centrale. 66	
Figura 54 – Tensioni ideali (SLU) per la sezione in campata.....	66
Figura 55 – Tensioni ideali (SLU) per la sezione in campata in corrispondenza dei fori di ispezione.....	67
Figura 56 – Sforzo normale (SLU)	71
Figura 57 – Momenti flettenti asse y (SLU)	71
Figura 58 – Momenti flettenti asse z (SLU).....	72
Figura 59 – Tagli asse y (SLU)	72
Figura 60 – Tagli asse z (SLU)	73
Figura 61 – Sforzo normale (SLV)	73
Figura 62 – Momenti flettenti asse y (SLV)	74
Figura 63 – Momenti flettenti asse z (SLV).....	74
Figura 64 – Tagli asse y (SLV)	75
Figura 65 – Tagli asse z (SLV)	75
Figura 66 – Sforzi di trazione (SLU)	80
Figura 67 – Sforzi di trazione (SLV)	80
Figura 68 – Sforzi di trazione per disattivazione strallo "I6" (SLU)	81

Figura 69 –Spostamenti verticali dell’impalcato (SLE rara)	82
Figura 70 –Spostamenti verticali dell’impalcato per i carichi veicolari	82
Figura 71 – Fase 1: Spostamenti verticali dei conci di impalcato per i pesi propri	83
Figura 72 – Fase 4: Spostamenti verticali dell’ impalcato a rimozione dei puntelli provvisori ed applicazione dei sovraccarichi permanenti.....	83
Figura 73 – Fase 4: Spostamenti verticali dell’ impalcato a seguito della pretensione degli stralli.....	84
Figura 74 – Fase 4: Spostamenti verticali dell’impalcato a lungo termine per effetto delle deformazioni finali da ritiro e viscosità del calcestruzzo dell’antenna	84
Figura 75 – Numerazione vincoli ed assi.....	85
Figura 76 – Azioni verticali sui pali (SLU)	89
Figura 77 – Azioni verticali sui pali (SLV)	90
Figura 78 – Azioni orizzontali in direzione x sui pali (SLV)	90
Figura 79 – Azioni orizzontali in direzione y sui pali (SLV)	91
Figura 80 – Momenti flettenti in direzione x (SLU)	94
Figura 81 – Momenti flettenti in direzione y (SLU)	94
Figura 82 – Momenti flettenti in direzione x (SLV)	95
Figura 83 – Momenti flettenti in direzione y (SLV)	95
Figura 84 – Tagli in direzione x (SLU).....	96
Figura 85 – Tagli in direzione y (SLU).....	96
Figura 86 – Tagli in direzione x (SLV).....	97
Figura 87 – Tagli in direzione y (SLV).....	97

LISTE DES TABLEAUX / INDICE DELLE TABELLE

Tabella 1. <i>Schema di carico 1</i>	21
Tabella 2. <i>Schema di carico 5 (folla compatta)</i>	21
Tabella 3. <i>Pressioni del vento</i>	26
Tabella 4. <i>Attivazione e disattivazione degli elementi, dei vincoli e dei carichi nelle fasi</i>	51
Tabella 5. <i>Reazioni massime e minime agli appoggi (SLU-SLV)</i>	86
Tabella 6. <i>Coefficienti parziali per le azioni o per l’effetto delle azioni</i>	88
Tabella 7. <i>Coefficienti parziali per i parametri geotecnici del terreno</i>	88

1. Premessa

La presente relazione è relativa al dimensionamento del Ponte Strallato del Sovrapasso di Ingresso, facente parte delle opere strutturali relative al “Collegamento Lione Torino – Rilocalizzazione dell’Autoporto di Susa”.

Nel seguito vengono quindi riportate le verifiche e la descrizione delle strutture facenti parte del ponte.

Dal punto di vista delle analisi strutturali il documento è stato redatto in osservanza delle Norme Tecniche per le Costruzioni di cui al DM 14/01/2008, utilizzando la metodologia di verifica agli Stati Limite.

2. Normativa di riferimento

Nella stesura della presente relazione si sono seguite le indicazioni contenute nella normativa vigente. In particolare si sono considerate le seguenti normative:

- **Legge 5 Novembre 1971 n. 1086** – “Norme per la disciplina delle opere in conglomerato cementizio, normale e precompresso ed a struttura metallica” ;
- **Circolare LL.PP. 14 Febbraio 1974 n. 11951** – “Norme per la disciplina delle opere in conglomerato cementizio, normale e precompresso ed a struttura metallica – Istruzioni per l'applicazione” ;
- **D.M. LL.PP. 14 Gennaio 2008** - “Norme tecniche per le costruzioni”;
- **Circolare LL.PP. 2 Febbraio 2009 n. 617** - Istruzioni per l'applicazione delle “Norme tecniche per le costruzioni” di cui al D.M. 14 gennaio 2008.
- **CNR – UNI 10011 – 92** – “Costruzioni di acciaio: Istruzioni per il calcolo, la esecuzione, il collaudo e la manutenzione”
- **CNR 10030/87** – “Anime irrigidite di travi a parete piena”
- **Eurocodice 2 – UNI EN 1992–1–1: 2005** – “Progettazione delle strutture di calcestruzzo - Parte 1-1: Regole generali e regole per gli edifici”
- **Eurocodice 2 – UNI EN 1992–2: 2006** - “Progettazione delle strutture di calcestruzzo - Parte 2: Ponti di calcestruzzo – Progettazione e dettagli costruttivi
- **Eurocodice 3 – UNI EN 1993–3: 2005** – “Progettazione delle strutture in acciaio”
- **Eurocodice 8 – UNI EN 1998–2: 2009** – “Indicazioni progettuali per la resistenza sismica delle strutture - Parte 2: Ponti”

impalcato sarà interamente in acciaio da carpenteria e gli stralli di sospensione andranno a sostenere l'impalcato dal solo lato esterno della curva, in quanto questo risulterà torsionalmente incastrato sulle due pile di estremità e sull'appoggio intermedio in corrispondenza dell'antenna. Proseguendo verso Nord, il tratto in viadotto sarà costituito da un ulteriore tratto di impalcato su due o tre campate, di lunghezza massima pari a 24m e struttura bitrave in acciaio con soletta collaborante in c.a. Le travi in acciaio delle campate adiacenti all'impalcato strallato, avranno altezza variabile, al fine di evitare discontinuità prospettiche tra i diversi tratti.



Figura 2 – Profilo longitudinale

Più in dettaglio, il ponte strallato autoancorato, oggetto della presente relazione, ha una lunghezza complessiva in asse impalcato di 90.32m, suddiviso in due campate di uguale luce tra gli appoggi di 44.76m ed un retrotrave di 0.40m, poggianti alle estremità su pile in c.a. in comune con gli impalcati dei tratti di viadotto adiacenti. La pila centrale di appoggio presenta ad una estremità una antenna in c.a., alta circa 22m rispetto all'estradosso pila ed inclinata di 65° rispetto all'orizzontale nel piano ortogonale all'asse impalcato. Ciascuna delle due campate dell'impalcato è sostenuta da sette stralli di sospensione con una tipica conformazione mista tra l'arpa (stralli paralleli) ed il ventaglio (stralli concentrici).

L'impalcato

La larghezza della carreggiata stradale è pari a 6.50m con due cordoli in c.a. laterali di larghezza pari a 0.80m e 2.40m, per una larghezza complessiva dell'impalcato pari a 9.70m. L'impalcato è composto da un'unica trave a cassone monocellulare torsionalmente rigida, interamente realizzato in acciaio in composizione saldata, ha andamento curvilineo con raggio di curvatura costante pari a circa 53m in asse impalcato.

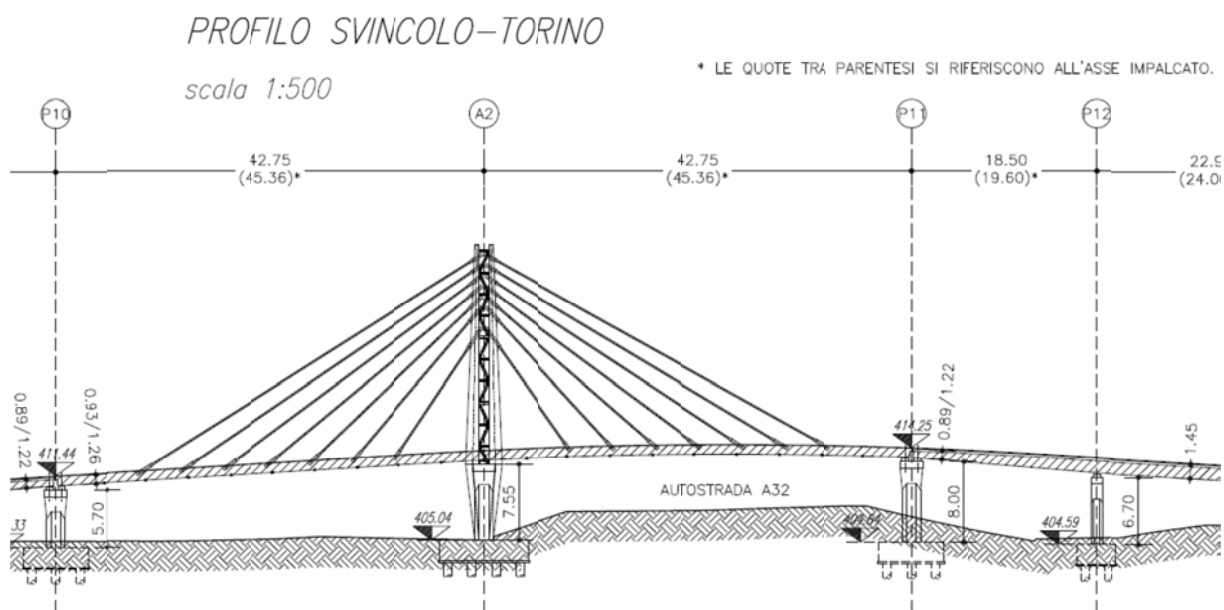

Figura 3 – Sezione tipo corrente

Il cassone disposto pressochè in posizione baricentrica rispetto all'asse impalcato ha larghezza di 5500mm ed altezza variabile tra 890mm e 1220mm. Lo spessore dei piatti in acciaio di anime e piattabande superiore ed inferiore è pari a 30mm. La piattabanda superiore, inclinata con la stessa pendenza trasversale della pavimentazione stradale, presenta, nel tratto della sede stradale all'intradosso, degli irrigidimenti longitudinali di forma trapezia ad interasse di 600mm realizzati con piatti di spessore 8mm. In corrispondenza del marciapiede esterno gli irrigidimenti longitudinali sono del tipo ad "L" così come quelli delle anime e della piattabanda inferiore. La piattabanda superiore nervata in direzione longitudinale e trasversale mediante traverse e traversi intermedi di spessore 16mm si configura come una piastra ortotropa. Saldato all'intradosso della piattabanda superiore dal lato del marciapiede è presente un tubo di diametro 406.4mm e spessore 16mm che ha la funzione oltre di irrigidimento longitudinale anche di ancoraggio delle testate degli stralli. In direzione trasversale all'impalcato ed in corrispondenza dell'ancoraggio degli stralli sono presenti dei traversi ad anima piena di spessore pari a 16mm che collegano il cassone al sistema di strallatura. Analoghi ai traversi intermedi sulle tre pile in corrispondenza degli apparecchi di appoggio sono presenti dei traversi di testata ad anima piena con spessore pari a 20mm.

Completano l'impalcato due cofanature laterali curve non strutturali, disposte per ripristinare la continuità visiva tra piastra inferiore ed estradosso impalcato e per migliorare la forma aerodinamica dell'impalcato. Tali rivestimenti, realizzati con pannelli removibili rivestiti in acciaio, consentono l'ispezione da un lato delle teste di ancoraggio degli stralli e dall'altro degli impianti di impalcato. Ai fini del varo della carpenteria metallica, si è ritenuto opportuno suddividere la travata in tre conci principali con lunghezza di arco pari a circa 35.8m per il concio centrale e pari a 27.45m per i due conci adiacenti. Si è ipotizzato che i singoli conci siano assemblati in composizione saldata a terra in apposita area di cantiere. Si procederà, quindi, al varo dei singoli conci mediante autogru su appoggi temporanei in corrispondenza delle tre pile e su un appoggio intermedio in ciascuna delle due campate. Si procederà alla giunzione mediante saldatura in opera dei suddetti conci per rendere monolitica la travata e poter rimuovere i due appoggi temporanei intermedi. E' prevista la parzializzazione ad una corsia per entrambi i sensi di marcia della sottostante carreggiata dell'A32 durante le fasi di varo dell'impalcato fino a rimozione dei puntelli provvisori intermedi.

Per quanto riguarda la protezione alla corrosione della carpenteria metallica si prevede la zincatura a caldo delle singole piastre preassemblate in officina. La successiva zincatura a freddo da realizzarsi in cantiere in corrispondenza dei cordoni di saldatura esterni ed interni al cassone e la definitiva verniciatura esterna protettiva mediante vernici metacriliche.

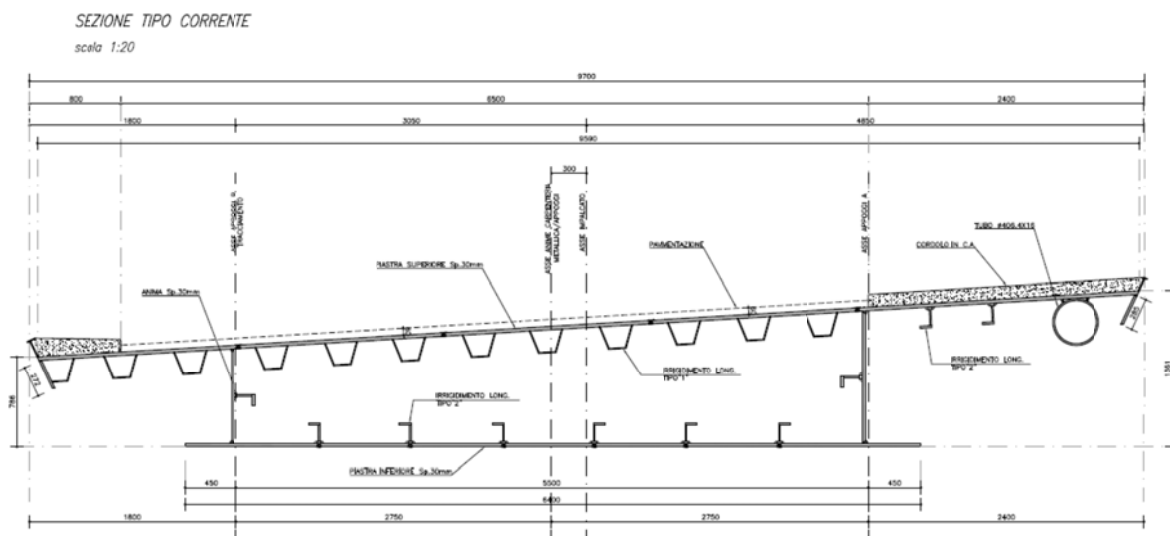

Figura 4 – Sezione in corrispondenza del traverso di pila

I collegamenti tra impalcato e pulvini sono realizzati mediante apparecchi di appoggio in acciaio-teflon con disco elastomerico confinato di diversa tipologia, ovvero di tipo fisso, multidirezionale, nonché unidirezionale in senso longitudinale o trasversale. In corrispondenza dei pulvini sono previsti due appoggi, uno per ciascuna anima del cassone. Sulla pila centrale è presente un dispositivo fisso, che vincola l'impalcato sia longitudinalmente che trasversalmente ed un dispositivo unidirezionale che consente gli scorrimenti in senso trasversale all'impalcato. Sulle pile laterali sono presenti appoggi multidirezionali ed unidirezionali che consentono gli scorrimenti in direzione longitudinale nella direzione della congiungente con il punto fisso in corrispondenza della pila centrale. Per garantire il corretto funzionamento degli appoggi esterni, si è prevista la precompressione mediante l'installazione di una fune spiroidale chiusa di diametro pari a 48mm tra traverso di testata e pulvino. Di fatti il peso dell'impalcato non è sufficiente a bilanciare le azioni di trazione che nascono in tali appoggi in seguito alla pretensione degli stralli.

SCHEMA APPOGGI
scala 1:500

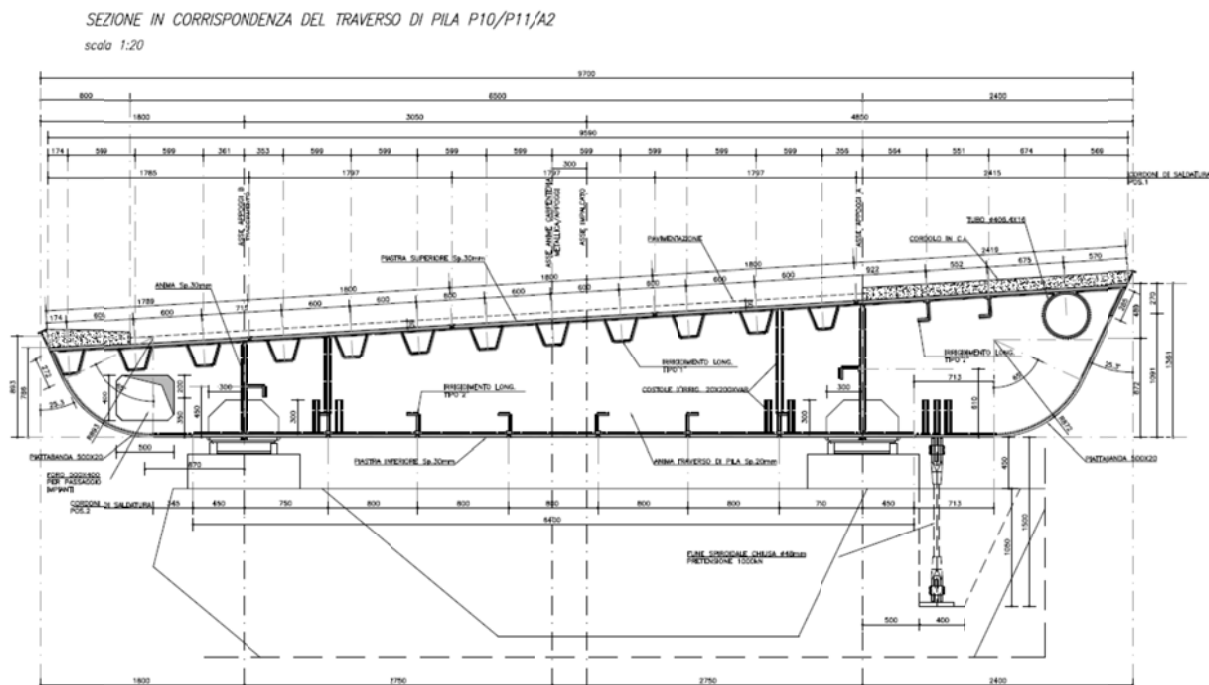

Figura 5 – Schema appoggi

Pile ed antenna

Le pile interamente piene in c.a. hanno forma ottagonale allungata di dimensioni costanti con l'altezza e con pulvini sovrastanti trapezoidali ed hanno altezza da estradosso fondazione ad estradosso pulvino pari rispettivamente a 5.70m per la pila P10 e 8.00m per la pila P11. Sul lato esterno della pila centrale A2 si innesta l'antenna del ponte strallato. La pila A2 ha altezza pari a 7.55m ed uno spessore pari a 1.80m all'innesto con la piastra di fondazione che tende ad allargarsi fino a 3.60m all'estradosso superiore in corrispondenza della sagoma di innesto tra antenna e pila.

consentire un più agevole raggiungimento delle testate degli stralli. L'accesso al cavedio è previsto dal marciapiede in corrispondenza dell'impalcato.

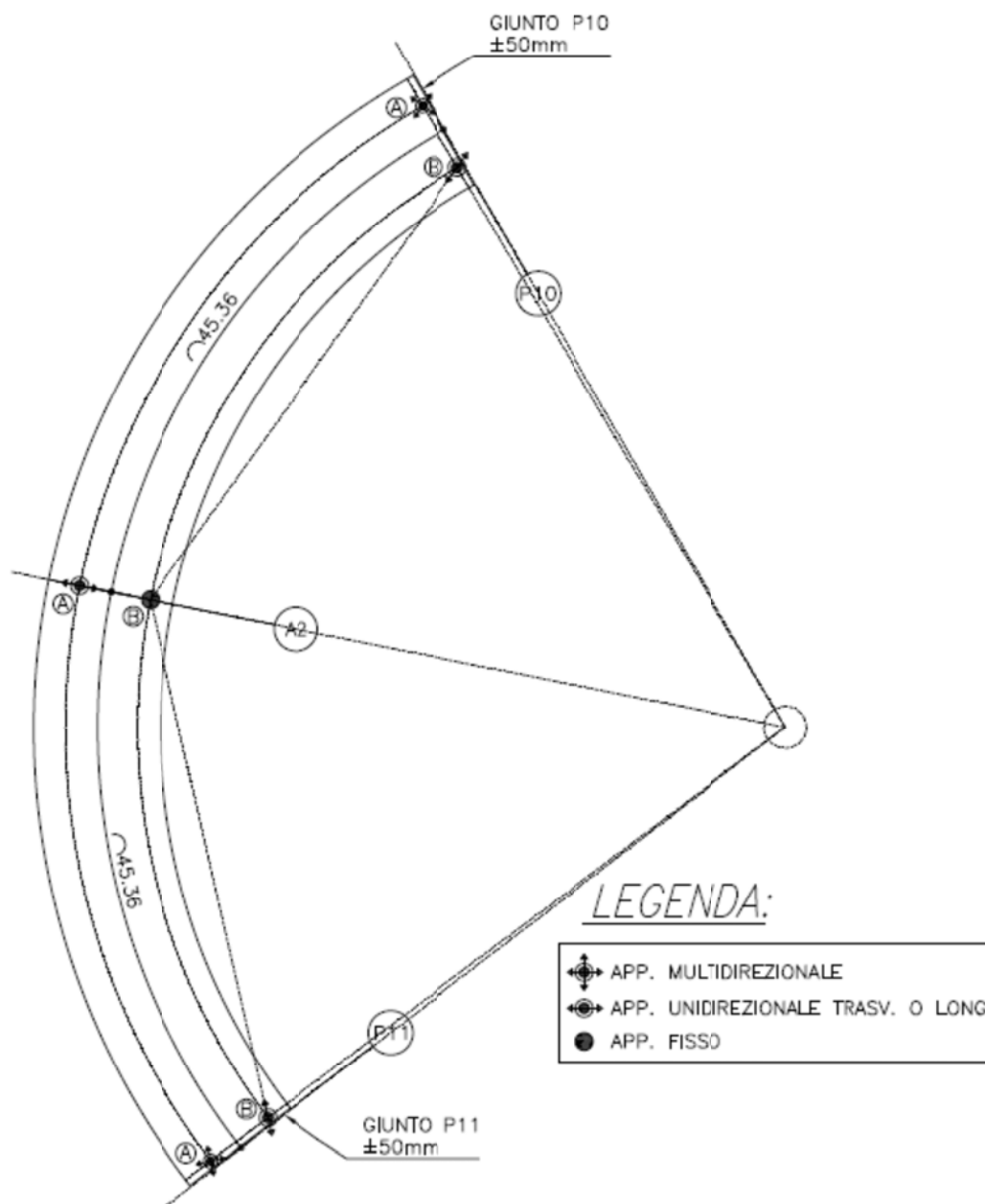

Figura 7 – Vista assonometrica della pila-antenna

Per quanto riguarda la protezione delle strutture in c.a. di pile ed antenna si prevede una verniciatura protettiva delle superfici mediante vernici a base di elastomeri poliuretanici.

Le fondazioni delle pile sono di tipo indiretto, realizzate con pali trivellati in c.a. $\phi 800\text{mm}$ collegati in testa da zattere in c.a. gettate in opera. Queste ultime hanno forma rettangolare con spessore pari a 2.00m.

La strallatura

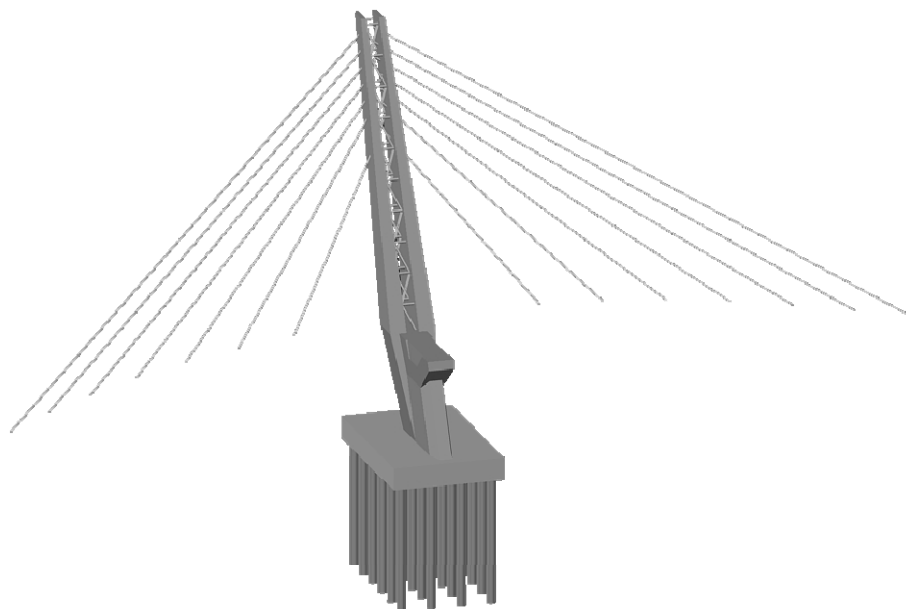
Gli stralli sono in numero di sette per ciascuna campata. Ogni strallo, di lunghezza variabile tra circa 18m e 48m, è costituito da un fascio di 31 trefoli a 7 fili da 0.6" (15.7mm , 150mm^2) di acciaio ad alta resistenza, zincati e viplati. La protezione dell'acciaio dei trefoli è costituita da:

- zincatura del trefolo
- guaina di viplatura
- iniezione di cera
- guaina esterna in HDPE

Il sistema di ancoraggio è del tipo a testata fissa in corrispondenza dell'antenna ed a testata regolabile in corrispondenza dell'impalcato. L'ancoraggio è realizzato mediante piastra di contrasto contro un tubo d'ancoraggio passante attraverso il tubo $\phi 406.4\text{mm}$ di impalcato ed ad esso saldato. La pretensione degli stralli è prevista, pertanto, dall'intradosso dell'impalcato. Tale scelta, seppur meno agevole rispetto ad una pretensione dall'estradosso dell'impalcato, consente una migliore protezione e durabilità della testata di ancoraggio regolabile.



Figura 8 – Schema tipologico degli stralli e dettaglio trefolo

4. Caratteristiche dei materiali

4.1 Conglomerato di classe di resistenza C35/45

(per i cordoli degli impalcati)

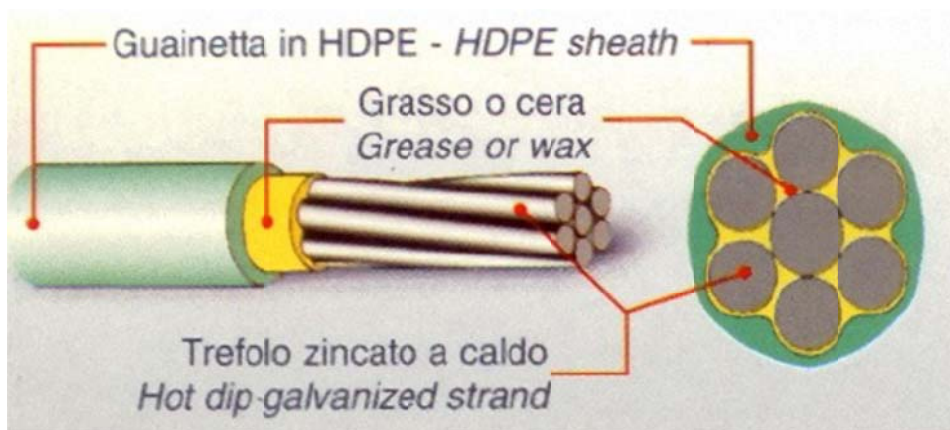
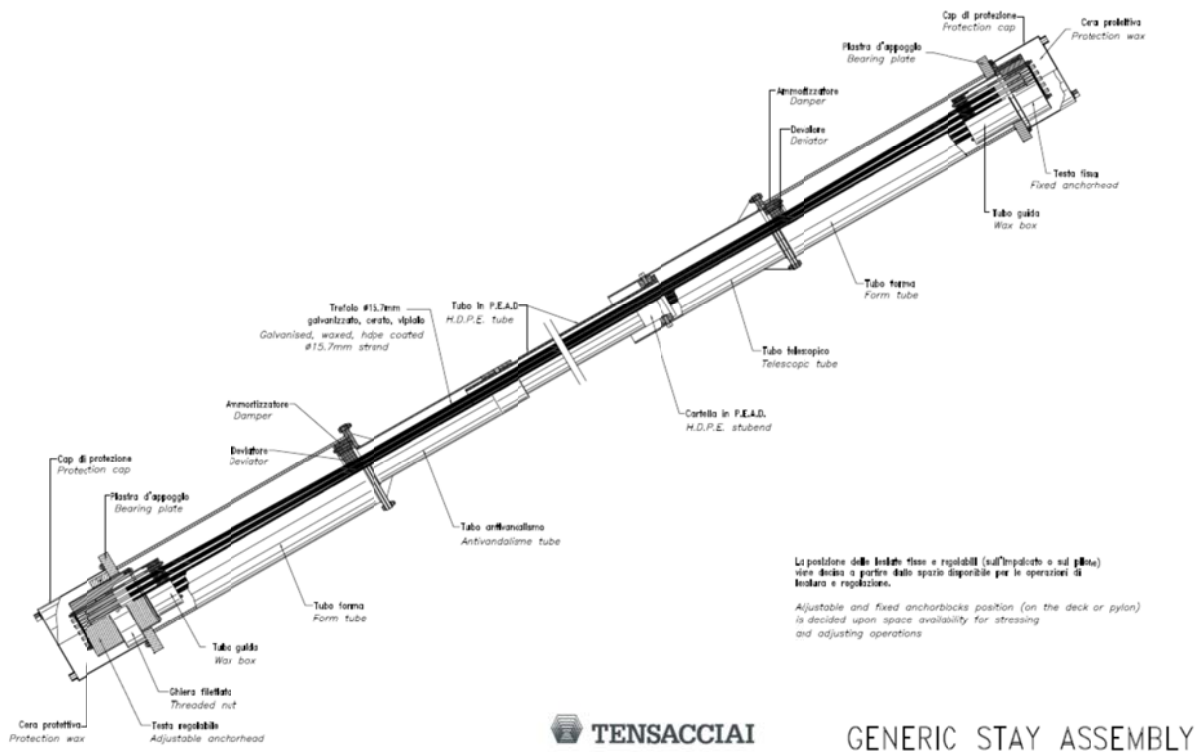
Modulo elastico	$E_c = 34077$	MPa
Coefficiente di Poisson	$\nu = 0.20$	
Coefficiente di dilatazione termica	$\alpha = 10 \times 10^{-6}$	°C ⁻¹
Coefficiente parziale di sicurezza	$\gamma_c = 1.5$	
Resistenza caratt. cubica a compressione	$R_{ck} = 45$	MPa
Resistenza caratt. cilindrica a compressione	$f_{ck} = 37.35$	MPa
Resistenza media cilindrica a compressione	$f_{cm} = 45.35$	MPa
Resistenza media a trazione semplice	$f_{ctm} = 3.35$	MPa
Resistenza caratteristica a trazione semplice	$f_{ctk} = 2.34$	MPa
Resistenza media a trazione per flessione	$f_{ctfm} = 4.02$	MPa
Resistenza di calcolo a compressione	$f_{cd} = 21.16$	MPa
Resistenza di calcolo a trazione	$f_{ctd} = 1.56$	MPa
Resistenza tang. caratteristica di aderenza	$f_{bk} = 5.26$	MPa
Resistenza tang. di aderenza di calcolo	$f_{bd} = 3.51$	MPa

4.2 Conglomerato di classe di resistenza C32/40

(per le sottostrutture)

Modulo elastico	$E_c = 33345$	MPa
Coefficiente di Poisson	$\nu = 0.20$	
Coefficiente di dilatazione termica	$\alpha = 10 \times 10^{-6}$	°C ⁻¹
Coefficiente parziale di sicurezza	$\gamma_c = 1.5$	
Resistenza caratt. cubica a compressione	$R_{ck} = 40$	MPa
Resistenza caratt. cilindrica a compressione	$f_{ck} = 33.20$	MPa
Resistenza media cilindrica a compressione	$f_{cm} = 41.20$	MPa
Resistenza media a trazione semplice	$f_{ctm} = 3.10$	MPa
Resistenza caratteristica a trazione semplice	$f_{ctk} = 2.17$	MPa
Resistenza media a trazione per flessione	$f_{ctfm} = 3.72$	MPa
Resistenza di calcolo a compressione	$f_{cd} = 18.81$	MPa
Resistenza di calcolo a trazione	$f_{ctd} = 1.45$	MPa
Resistenza tang. caratteristica di aderenza	$f_{bk} = 4.88$	MPa
Resistenza tang. di aderenza di calcolo	$f_{bd} = 3.25$	MPa

4.3 Conglomerato di classe di resistenza C28/35

(per le strutture di fondazione)

Modulo elastico	$E_c = 32588$	MPa
Coefficiente di Poisson	$\nu = 0.20$	
Coefficiente di dilatazione termica	$\alpha = 10 \times 10^{-6}$	°C ⁻¹
Coefficiente parziale di sicurezza	$\gamma_c = 1.5$	
Resistenza caratt. cubica a compressione	$R_{ck} = 35$	MPa
Resistenza caratt. cilindrica a compressione	$f_{ck} = 29.05$	MPa
Resistenza media cilindrica a compressione	$f_{cm} = 37.05$	MPa
Resistenza media a trazione semplice	$f_{ctm} = 2.83$	MPa
Resistenza caratteristica a trazione semplice	$f_{ctk} = 1.98$	MPa
Resistenza media a trazione per flessione	$f_{ctfm} = 3.40$	MPa
Resistenza di calcolo a compressione	$f_{cd} = 16.46$	MPa
Resistenza di calcolo a trazione	$f_{ctd} = 1.32$	MPa
Resistenza tang. caratteristica di aderenza	$f_{bk} = 4.45$	MPa
Resistenza tang. di aderenza di calcolo	$f_{bd} = 2.97$	MPa

4.4 Acciaio da c.a. tipo B450C saldabile

(per barre e reti di diametro $6.0\text{mm} \leq \varnothing \leq 40.0\text{mm}$)

Coefficiente parziale di sicurezza	$\gamma_s = 1.15$	
Tensione caratteristica di snervamento	$f_{yk} \geq 450$	MPa
Tensione caratteristica di rottura	$f_{tk} \geq 540$	MPa
Allungamento	$A_{gtk} \geq 7.5\%$	
Resistenza di calcolo	$f_{yd} = 391$	MPa

4.5 Acciaio armonico per stralli

(per trefoli a 7 fili di diametro nominale \varnothing
15.7 mm)

Coefficiente parziale di sicurezza	$\gamma_s = 1.15$	
Tensione caratteristica di rottura a trazione	$f_{pyk} \geq 1860$	MPa
Tensione caratteristica 1% di deformazione	$f_{p(1)k} \geq 1670$	MPa
Modulo elastico	$E_p \geq 196000$	MPa
Allungamento caratteristico a rottura	$\epsilon_{uk} \geq 35\%$	
Resistenza di calcolo	$f_{pyd} = f_{p(1)k} / \gamma_s = 1452$	MPa

4.6 Acciaio da carpenteria metallica S355 JO (Rif. UNI EN 10025-2)

(per piatti e profilati metallici)

Modulo elastico (convenzionale)	$E_s = 210000$	MPa
Modulo elasticità trasversale	$G = 80769$	MPa
Coefficiente di Poisson	$\nu = 0.30$	
Tensione di snervamento	$f_{yk} = 355$	MPa
Tensione di rottura	$f_{tk} = 510$	MPa
Resistenza di calcolo	$f_{yd} = f_{yk} / \gamma_{M0} = 338$	MPa

4.7 Bulloni di classe 8.8 e dadi classe 8.0

Tensione di rottura (UNI 3740)	$f_{tb} = 800$	MPa
Tensione di snervamento (UNI 3740)	$f_{yb} = 649$	MPa

4.8 Collegamenti in unioni saldate

Le saldature di elementi in acciaio devono essere effettuate con uno dei procedimenti all'arco elettrico codificati secondo la norma UNI EN ISO 4063/2001. Tutti i procedimenti di saldatura, (manuali, semiautomatici, automatici o robotizzati) dovranno essere qualificati secondo la norma UNI EN ISO 15614-1/2005. Nell'esecuzione delle saldature dovranno inoltre essere rispettate le norme UNI EN 1011/2005 parti 1 e 2 per gli acciai ferritici e della parte 3 per gli acciai inossidabili. La preparazione dei lembi dovrà essere eseguita secondo la norma UNI EN ISO 9692-1/2005.

5. Azioni di progetto

I valori delle azioni, di seguito assunti, sono stati considerati come valori caratteristici nelle verifiche agli stati limite. Si riportano di seguito le analisi dei carichi unitari applicati alle membrature costituenti la struttura.

Le azioni di progetto, in accordo con quanto prescritto dal D.M. 18.01.2008, vengono di seguito elencate:

5.1 Azioni gravitazionali

Peso proprio elementi strutturali in c.a. ed acciaio:

Calcestruzzo ordinario armato	25.00 kN/m ³
Acciaio da carpenteria metallica	78.50 kN/m ³

Nel dettaglio, i carichi per peso proprio delle pile, dell'antenna, dell'impalcato in acciaio e degli stralli sono automaticamente determinati dal programma di analisi strutturale in funzione delle geometrie degli elementi e del peso specifico dei materiali associati.

IMPALCATO

Permanenti portati

Pavimentazione:

$$1.30 \text{ kN/m}^2 * 6.50 \text{ m} = 8.45 \text{ kN/m}$$

Guard-rail:

$$1.00 \text{ kN/m}$$

Recinzione di protezione:

$$1.00 \text{ kN/m}$$

Condotte:

$$0.50 \text{ kN/m}$$

Cordoli:

$$0.80 * 0.13 * 25.00 \text{ kN/m}^3 = 2.60 \text{ kN/m}$$

$$2.40 * 0.11 * 25.00 \text{ kN/m}^3 = 6.60 \text{ kN/m}$$

Carter:

$$(1.3+2.35) * 0.30 \text{ kN/m}^2 = 1.10 \text{ kN/m}$$

I carichi permanenti portati sono stati assegnati come carichi distribuiti con le effettive eccentricità rispetto all'asse impalcato.



Figura 9 – Sovraccarichi permanenti G2

5.2 Azioni variabili da traffico

La carreggiata della rampa di uscita in corrispondenza del ponte strallato presenta una larghezza pari a 6.50m, a cui si aggiunge un marciapiede di larghezza pari a 2.40m. Ai fini della determinazione degli effetti prodotti dalle azioni variabili da traffico, l'asse viario di 1^a Categoria è stato suddiviso in n.2 corsie convenzionali di larghezza 3.00m (denominate nella modellazione c1a e c1b), ed un'area rimanente di larghezza pari a 0.50m. I carichi da considerare per ponti di prima categoria sono quelli indicati dalla normativa vigente e schematizzati nel modo seguente:

- i relativi carichi veicolari (tandem + distribuiti) secondo NTC08, viaggianti longitudinalmente lungo le corsie stesse, al fine di ottenere le relative linee di influenza e le massime azioni necessarie al dimensionamento.

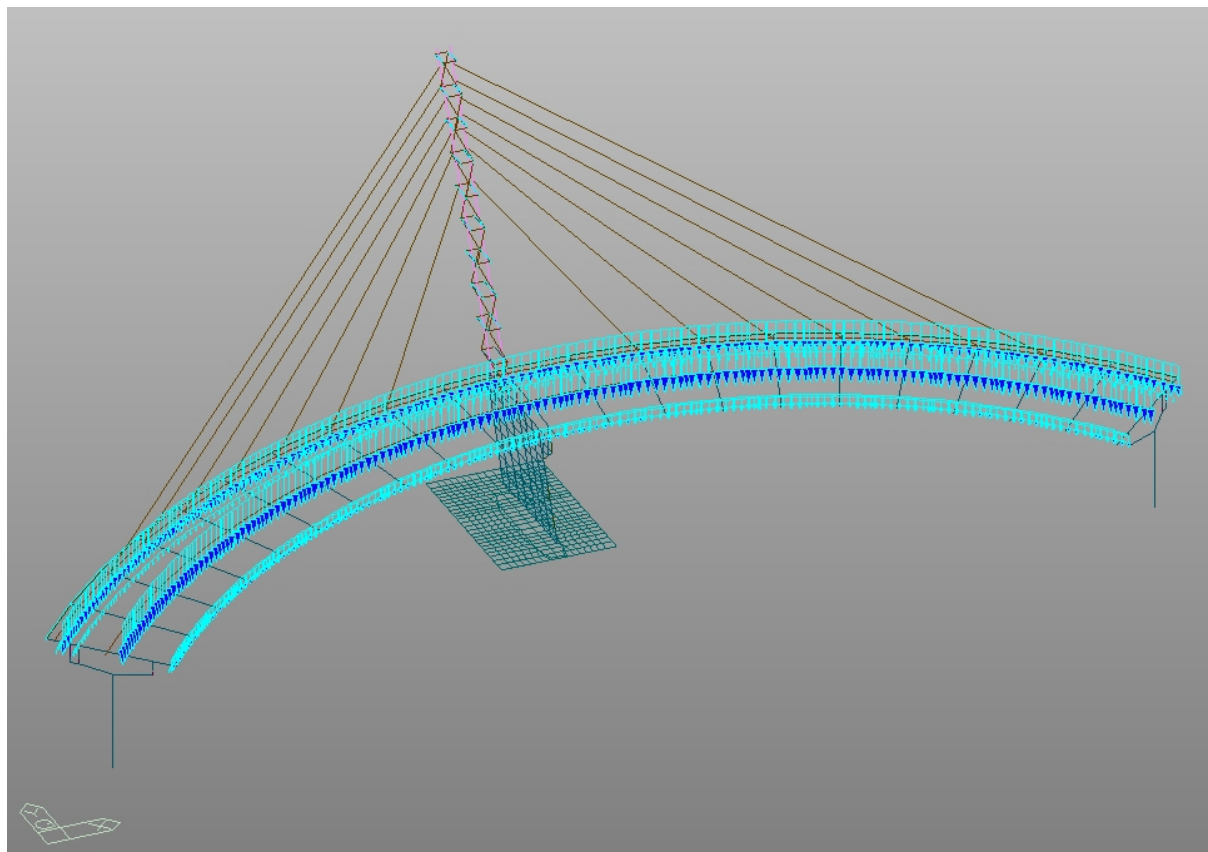
Tali carichi mobili sono stati disposti sia separatamente che contemporaneamente sulle due corsie di progetto.

Sono stati applicati i carichi definiti dagli Schemi di carico 1-5 così come indicato al par. 5.1.3.3.3 del D.M. 14/01/2008:

Gli schemi adottati per le verifiche globali sono i seguenti:

Corsia	Carico asse Qik [kN]	Numero assi	Carico distribuito qik [kN/m2]
1	300	2	9.00
2	200	2	2.50
3	100	2	2.50
4	-	2	2.50
Area rimanente	-	-	2.50
Marciapiede	-	-	2.50

Tabella 1. Schema di carico 1

Corsia	Carico asse Qik [kN]	Numero assi	Carico distribuito qik [kN/m2]
1	-	-	-
2	-	-	-
3	-	-	-
4	-	-	-
Area rimanente	-	-	-
Marciapiede	-	-	5.00

Tabella 2. Schema di carico 5 (folla compatta)

Più in dettaglio, per lo schema di carico 1 sono state definite due condizioni di carico:

Moving load case Q1a in cui le corsie sono posizionate per avere la massima eccentricità dei carichi mobili dal lato interno della curva;

Moving load case Q1b in cui le corsie sono posizionate per avere la massima eccentricità dei carichi mobili dal lato esterno della curva.



Figura 11 – Moving load case Q1a



Figura 12 – Moving load case Q1b

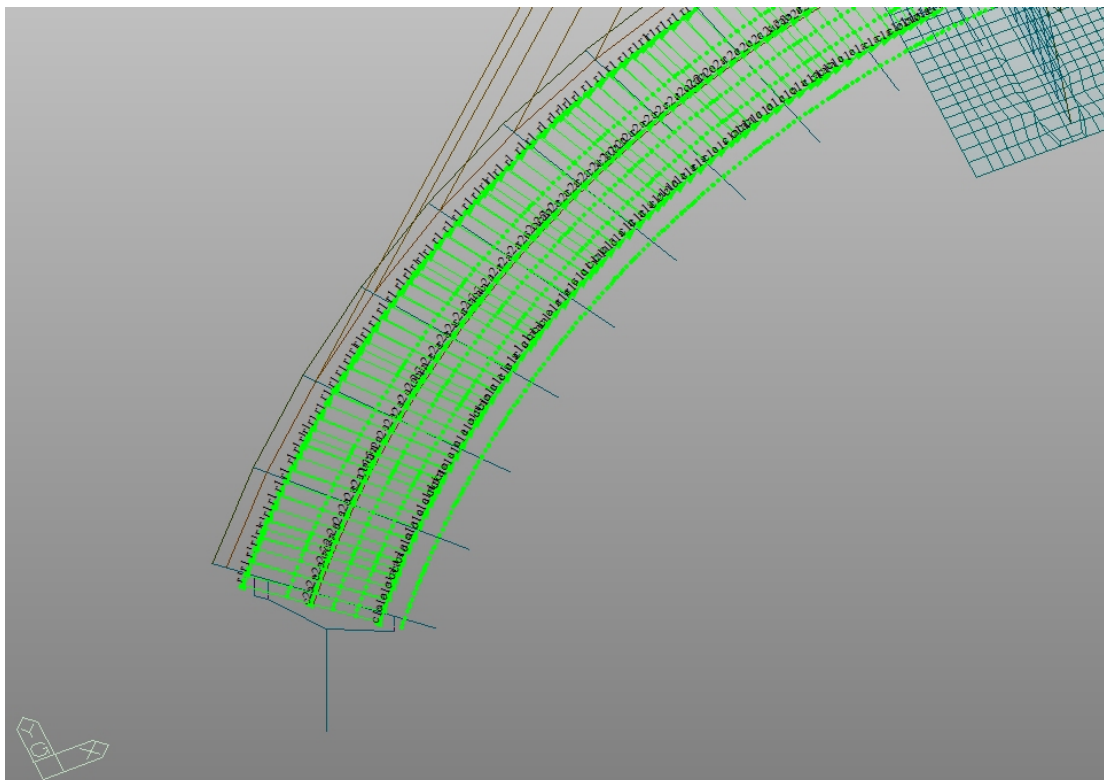

Figura 13 – Posizione dei carichi mobile per la massimazione del momento flettente in campata

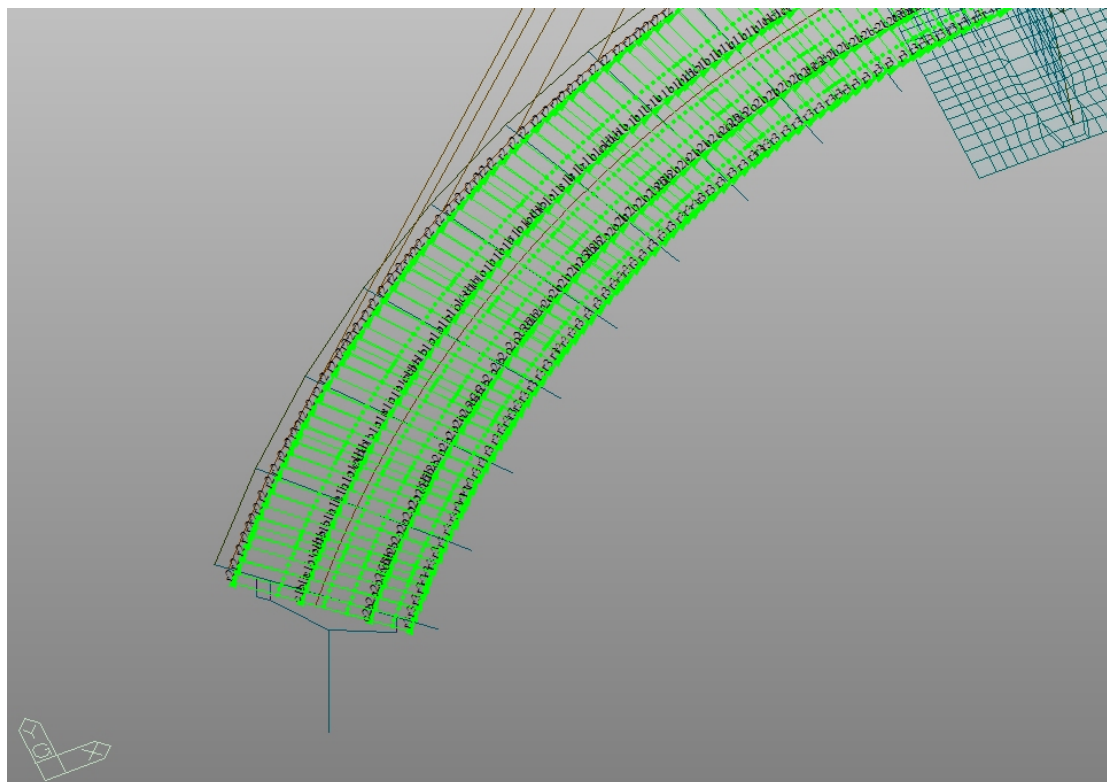

Figura 14 – Posizione dei carichi mobile per la massimazione del momento flettente sull'appoggio centrale

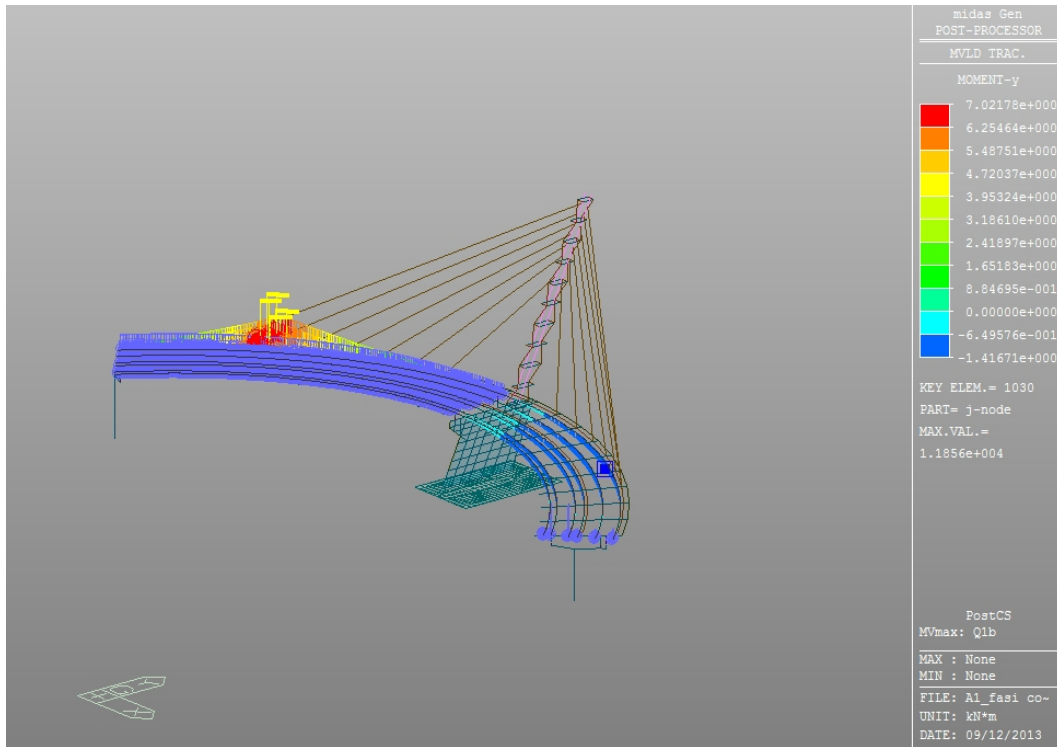

Figura 15 – Posizione dei carichi mobile per la massimazione del momento torcente sull'appoggio centrale

Per il dimensionamento locale della piastra superiore nervata dell'impalcato, oltre allo **Schema di Carico 1**, si è utilizzato nella modellazione anche lo **Schema di Carico 2**.

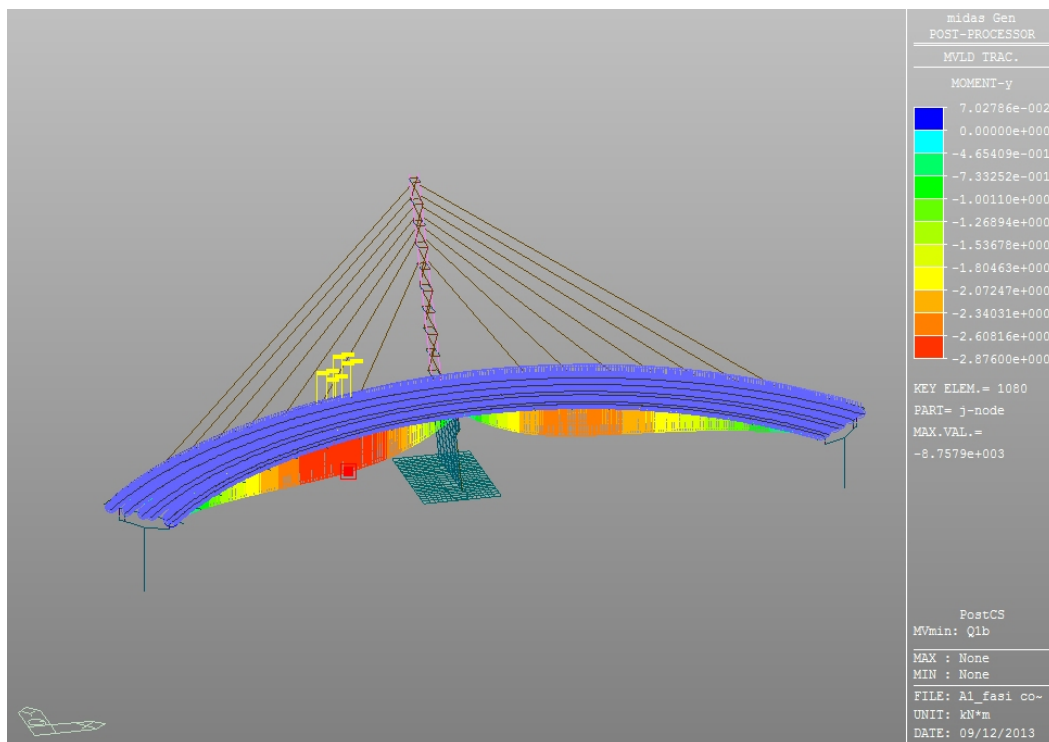
In tal caso per entrambi gli schemi di carico si è considerata la diffusione dei carichi concentrati fino al piano medio della piattabanda superiore di 30mm della piastra ortotropa.

5.3 Azioni longitudinale di frenamento o di accelerazione

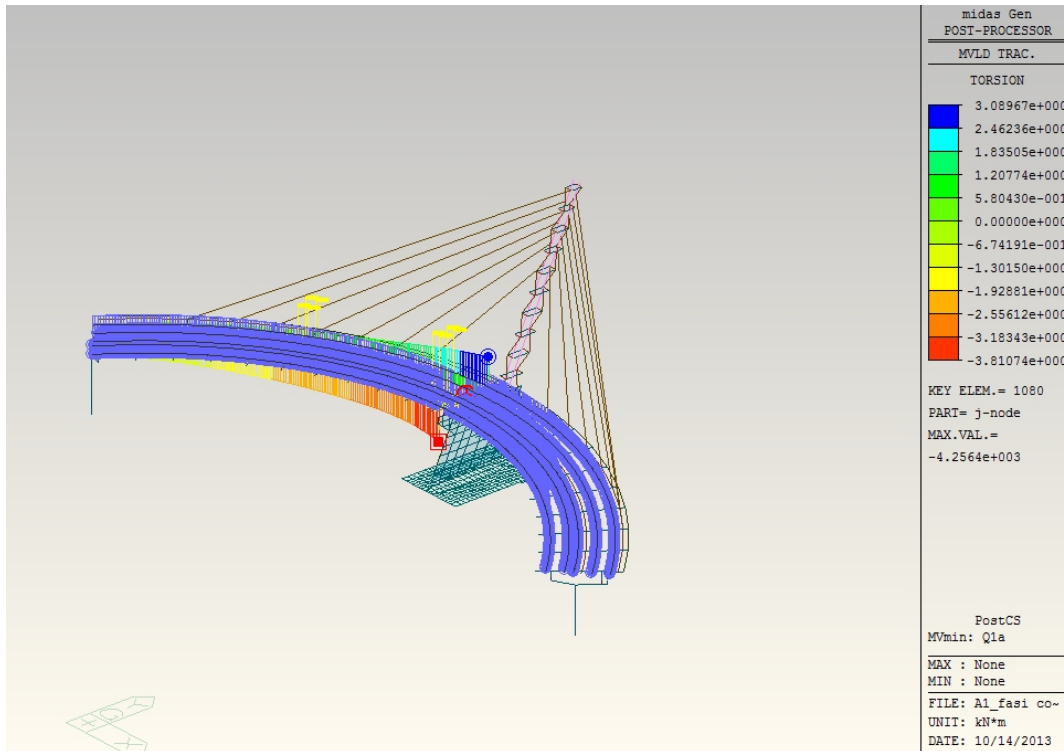
Per i ponti di 1^a categoria, la forza di frenamento o di accelerazione è pari a:

$$180 \text{ kN} \leq q_3 = 0.6 (2Q_{1k}) + 0.10 q_{1k} w_1 L \leq 900 \text{ kN}$$

dove:

- $Q_{1k} = 300 \text{ kN}$ è il carico per asse sulla corsia convenzionale 1;
- $q_{1k} = 9 \text{ kN/m}^2$ è il carico distribuito sulla corsia convenzionale 1;
- $w_1 = 3 \text{ m}$ è la larghezza della corsia convenzionale 1;
- L è la lunghezza della zona caricata, pari a 86.15m associato a Q1a e 92.15m associato a Q1b.

Pertanto risulta:

$$\begin{aligned} F &= 592.6 \text{ kN} && \text{(corsia n.1 lato interno)} \\ F &= 608.8 \text{ kN} && \text{(corsia n.1 lato esterno)} \end{aligned}$$

Questa forza, applicata a livello della pavimentazione ed agente lungo l'asse della corsia convenzionale, è stata assunta uniformemente distribuita sulla lunghezza caricata.

5.4 Azione centrifuga

Essendo il raggio di curvatura $R < 200\text{m}$, l'azione centrifuga si valuta convenzionalmente come:

$$Q_4 = 0.2 Q_v \text{ [kN]}$$

in cui $Q_v = \sum_i 2 Q_{ik} = 200\text{kN}$ è il carico totale dovuto agli assi tandem dello schema di carico 1 agenti sul ponte.

5.5 Azione del vento e della neve

Le pressioni e depressioni dovute al vento sono state calcolate rispettando il DM 18.01.2008. I coefficienti per il calcolo delle pressioni sono stati ricavati considerando i seguenti dati:

ZONA: I

$T_R=200$ anni

Classe di rugosità del terreno: D

Categoria di esposizione del sito: II

$c_t=1$

$c_d=1$

$c_p= 1.4$ (impalcato)

$c_p= 2.8$ (antenna)

$a_s=415.00\text{m}$

$v_{b0}=25\text{m/s}$;

$v_b(T_R)=\alpha_R(T_R) \cdot v_{ref}=1.076 * 25=26.9\text{m/s}$;

$q_b=0.5 * 1.25 * 27^2 = 573\text{N/m}^2 = 455.6 \text{ N/m}^2$;

La pressione del vento (a meno del coefficiente c_p) è funzione della quota z e vale:

z m	c_e (eq. 3.3.5)	p kN/m ²
0.00	1.80	0.815
2.00	1.80	0.815
4.00	1.80	0.815
4.50	1.87	0.845
5.00	1.93	0.873
6.00	2.04	0.922
7.00	2.13	0.964
8.00	2.21	1.001
9.00	2.29	1.034
10.00	2.35	1.064
11.10	2.42	1.094
12.10	2.47	1.120
13.10	2.53	1.143
14.10	2.57	1.165
15.10	2.62	1.186
16.10	2.66	1.205
17.10	2.70	1.223
18.10	2.74	1.241
19.10	2.78	1.257
20.10	2.81	1.273

21.10	2.85	1.288
22.10	2.88	1.302
23.10	2.91	1.316
24.10	2.94	1.330
25.10	2.97	1.343
26.10	2.99	1.355
27.10	3.02	1.367
28.10	3.05	1.379
29.10	3.07	1.390

Tabella 3. Pressioni del vento

5.5.1 Vento a ponte scarico

L' azione del vento sull'impalcato viene considerata agente su una altezza comprensiva della trave, dei cordoli, della barriera e della rete di protezione.

Il carico a metro lineare vale:

$$q = 5.16 \text{ kN/m.}$$

posto ad una eccentricità verticale di 0.63m rispetto all'estradosso trave.

5.5.2 Vento a ponte carico

L' azione del vento sull'impalcato viene considerata agente su una altezza comprensiva della trave, della pavimentazione e del mezzo convenzionale (h=3.00m).

Il carico a metro lineare vale:

$$q = 6.40 \text{ kN/m.}$$

posto ad una eccentricità verticale di 1.05m rispetto all'estradosso trave.

5.5.3 Neve

L' azione della neve non essendo concomitante con i carichi variabili da traffico è stata considerata solo durante le fasi costruttive ed in particolare si è assunto il valore:

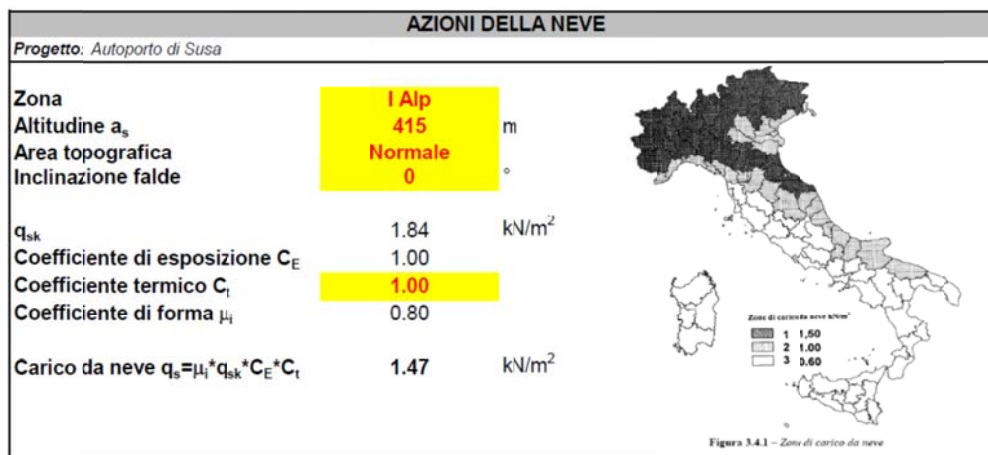

5.6 Attrito ai vincoli

Si considera una forza d'attrito pari al 3% del carico verticale permanente.

5.7 Urto di veicolo in svio

La barriera metallica laterale è di tipo bordo ponte classe H4, a tripla onda con montanti verticali costituiti da profili HEA 100 ad interasse 1.50 m. Considerando il modulo di resistenza plastico del profilo pari a $W_{pl} = 83.01 \text{ cm}^3$ ed una tensione di rottura pari ad $f_t = 430 \text{ MPa}$, si ottiene un momento ultimo sul montante pari a:

$$M_u = 83.01 \times 430 / 1000 = 35.7 \text{ kNm.}$$

Considerando, a vantaggio di sicurezza che l'urto avvenga a 0.60m dalla base del montante, il taglio corrispondente al momento ultimo vale:

$$V = 35.7 / 0.60 = 59.5 \text{ kN.}$$

5.8 Ritiro e viscosità del calcestruzzo dell'antenna

Si sono considerate le seguenti variazioni temporali della deformazione da ritiro e del coefficiente di viscosità:

Name : C32/40-antenna Code : European

European

Characteristic compressive cylinder strength of concrete at the age of 28 days (fck) : 32000 kN/m²

Relative Humidity of ambient environment (40 - 99) : 70 %

Notational size of member : 0.6 m
h = 2 * Ac / u (Ac : Section Area, u : Perimeter in contact with atmosphere)

Type of cement
 Class S Class N Class R

Type of code
 EN 1992-1 (General Structure) EN 1992-2 (Concrete Bridge) Use of silica-fume

Age of concrete at the beginning of shrinkage : 3 day

Figura 16 – Parametri adottati



Figura 17 – Andamento temporale delle deformazioni da ritiro



Figura 18 – Andamento temporale del coefficiente di viscosità

5.9 Variazioni termiche

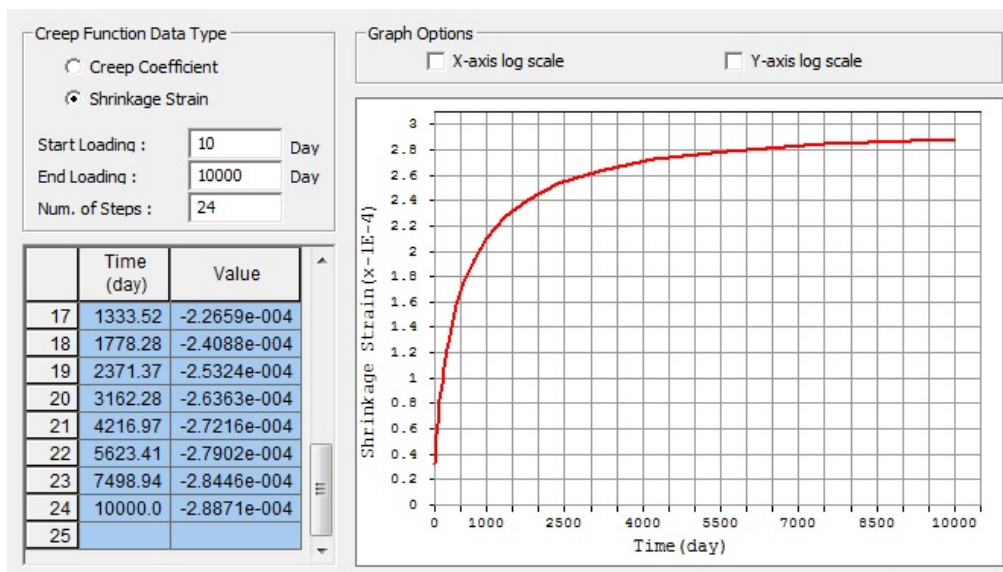
Secondo NTC2008, si prende in esame una variazione termica stagionale uniforme di $\pm 25^{\circ}\text{C}$ rispetto alla temperatura media, per la valutazione delle escursioni termiche ed il dimensionamento degli apparecchi di appoggio mobili e dei coprigiunti di impalcato. Per le strutture in c.a. si è considerata una variazione termica uniforme di $\pm 15^{\circ}\text{C}$. Per il dimensionamento dell'impalcato si è considerata anche in alternativa una variazione termica variabile linearmente con l'altezza della trave con gradiente pari a $\pm 10^{\circ}\text{C/m}$. Per il dimensionamento dei soli stralli si è considerata anche una variazione termica stagionale uniforme di $\pm 40^{\circ}\text{C}$ rispetto alla temperatura media.

5.10 Pretensione stralli

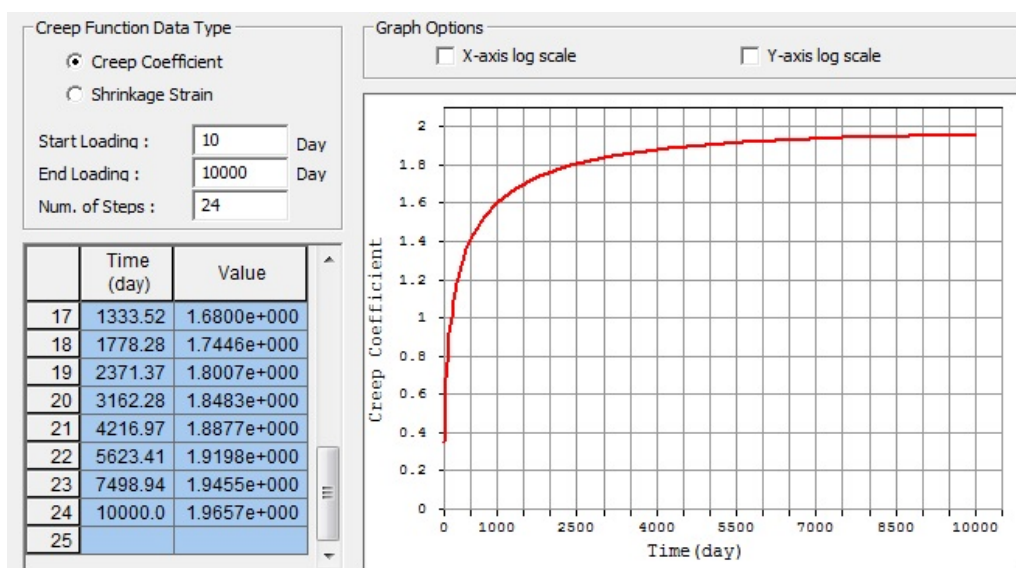
Si è applicata agli stralli una pretensione minima, affinché, per effetto delle altre azioni di progetto gli stralli risultino sempre tesi. Poiché i valori di pretensione applicati erano tali da mandare in trazione gli appoggi esterni, si è applicata una precompressione di tali appoggi mediante funi pretese a 1000kN. Ovvero si sono applicate le seguenti pretensioni:



Figura 19 – Carichi di pretensione

5.11 Azioni sismiche

- Vita nominale e periodo di riferimento

Per la struttura in oggetto, si assume la vita nominale utile pari a $V_N = 100$ anni, trattandosi di un'opera di importanza normale.

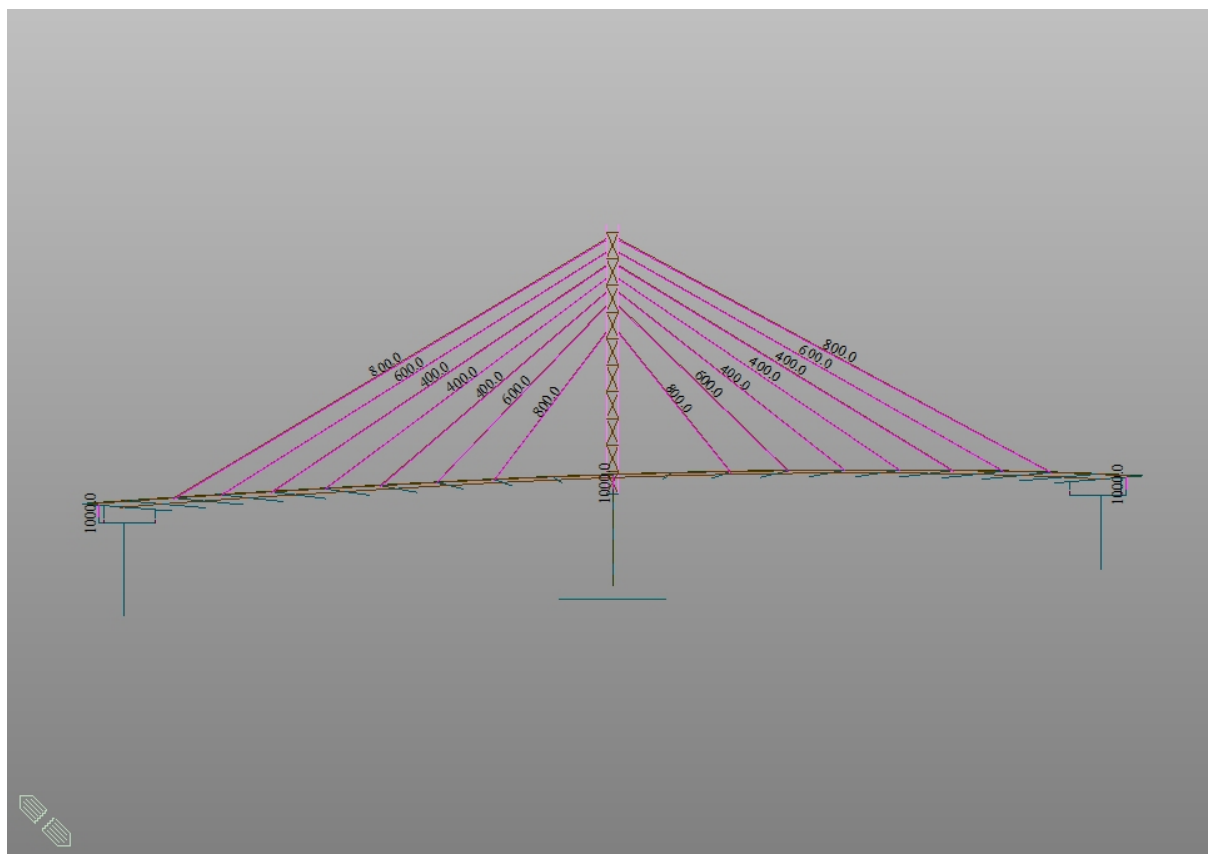
Ai fini della valutazione delle azioni sismiche, e con riferimento alle conseguenze di un'improvvisa interruzione di operatività o di un eventuale collasso, è stato assunto che la struttura in esame appartenga alla Classe IV. In base alla classe d'uso, è stato definito un coefficiente d'uso $C_U = 2.0$, mediante il quale si perviene alla definizione del periodo di riferimento per l'azione sismica $V_R = V_N \times C_U = 200$ anni.

Le probabilità di superamento PVR nel periodo di riferimento V_R , sono stabilite dalla norma in funzione dei differenti stati limite; per lo SLV si ha $PVR = 10\%$.

In funzione dei valori del periodo di riferimento V_R e della probabilità di superamento PVR , si definisce il periodo di ritorno TR mediante la relazione:

$$T_R = -\frac{V_R}{\ln(1 - P_{VR})}$$

Per lo SLV si ha:

$$SLV \rightarrow T_R = 1898 \text{ anni}$$

La struttura in oggetto ricade nel comune di San Didero (TO), più precisamente in località Maddalena, nell'alta Valle di Susa, cui sono assegnati, nella mappatura di microzonazione sismica, i seguenti valori dei parametri di pericolosità sismica relativi allo SLV:

$$\begin{aligned} a_g &= 0.200 \text{ g} \\ F_0 &= 2.524 \\ T_c^* &= 0.279 \text{ s} \end{aligned}$$

• Caratterizzazione sismica dei terreni

Con riferimento alle prospezioni geologiche effettuate ed alle indicazioni contenute in norma, è stato possibile classificare la categoria di sottosuolo del sito in oggetto, al fine di determinare gli effetti di amplificazione sismica locale dovuti alle conformazioni geologiche presenti.

Stante le ricostruzioni stratigrafiche effettuate sulla base di prove in sito di caratterizzazione meccanica, il sottosuolo si può classificare come categoria **B** ossia *“Rocce tenere e depositi di terreni a grana grossa molto addensati o terreni a grana fina molto consistenti con spessori superiori a 30 m, caratterizzati da un graduale miglioramento delle proprietà meccaniche con la profondità e da valori di $V_{s,30}$ compresi tra 360 m/s e 800 m/s (ovvero $N_{SPT,30} > 50$ nei terreni a grana grossa e $c_{u,30} > 250$ kPa nei terreni a grana fina)”*

Dato l'andamento clivometrico della zona, essa si classifica come categoria topografica **TI**, caratterizzata da pendii con inclinazione media $i < 15^\circ$. Ne consegue che i valori dei coefficienti di amplificazione stratigrafica S_s e C_c sono pari a:

$$S_s = 1.198 \quad C_c = 1.42$$

• Spettri di progetto

Lo spettro di risposta elastico della componente orizzontale è definito dalle espressioni seguenti:

$$\begin{aligned} 0 \leq T < T_B & \quad S_e(T) = a_g \cdot S \cdot \eta \cdot F_0 \cdot \left[\frac{T}{T_B} + \frac{1}{\eta \cdot F_0} \left(1 - \frac{T}{T_B} \right) \right] \\ T_B \leq T < T_C & \quad S_e(T) = a_g \cdot S \cdot \eta \cdot F_0 \\ T_C \leq T < T_D & \quad S_e(T) = a_g \cdot S \cdot \eta \cdot F_0 \cdot \left(\frac{T_C}{T} \right) \\ T_D \leq T & \quad S_e(T) = a_g \cdot S \cdot \eta \cdot F_0 \cdot \left(\frac{T_C T_D}{T^2} \right) \end{aligned}$$

Lo spettro di progetto $S_d(T)$ da utilizzare per le componenti orizzontali è lo spettro elastico corrispondente riferito alla probabilità di superamento nel periodo di riferimento P_{VR}

considerata, con le ordinate ridotte sostituendo nelle formule precedenti η con $1/q$, dove q è il fattore di struttura.

Il valore di q da utilizzare per ciascuna direzione orizzontale dell'azione sismica, dipende dalla tipologia strutturale, dal suo grado di iperstaticità e dai criteri di progettazione adottati e prende in conto le non linearità di materiale. Esso può essere calcolato tramite la seguente espressione:

$$q = q_0 \times K_R$$

dove:

- $q_0 = 1.0$ per le pile e l'antenna inclinata inflesse in cemento armato in classe di duttilità bassa CD"B" (Tab. 7.9.I del D.M. 14/01/2008);
- $K_R = 1.0$ per strutture regolari in altezza.

Si riportano di seguito gli spettri di progetto calcolati.

Parametri e punti dello spettro di risposta orizzontale per lo stato limite: SLV

Parametri indipendenti

STATO LIMITE	SLV
a_g	0.200 g
F_o	2.524
T_C^*	0.279 s
S_S	1.198
C_C	1.420
S_T	1.000
q	1.000

Parametri dipendenti

S	1.198
η	1.000
T_B	0.132 s
T_C	0.396 s
T_D	2.401 s

Espressioni dei parametri dipendenti

$$S = S_S \cdot S_T \quad (\text{NTC-08 Eq. 3.2.5})$$

$$\eta = \sqrt{10/(5 + \xi)} \geq 0,55; \quad \eta = 1/q \quad (\text{NTC-08 Eq. 3.2.6; §. 3.2.3.5})$$

$$T_B = T_C / 3 \quad (\text{NTC-07 Eq. 3.2.8})$$

$$T_C = C_C \cdot T_C^* \quad (\text{NTC-07 Eq. 3.2.7})$$

$$T_D = 4,0 \cdot a_g / g + 1,6 \quad (\text{NTC-07 Eq. 3.2.9})$$

Espressioni dello spettro di risposta (NTC-08 Eq. 3.2.4)

$$0 \leq T < T_B \quad S_e(T) = a_g \cdot S \cdot \eta \cdot F_o \cdot \left[\frac{T}{T_B} + \frac{1}{\eta \cdot F_o} \left(1 - \frac{T}{T_B} \right) \right]$$

$$T_B \leq T < T_C \quad S_e(T) = a_g \cdot S \cdot \eta \cdot F_o$$

$$T_C \leq T < T_D \quad S_e(T) = a_g \cdot S \cdot \eta \cdot F_o \cdot \left(\frac{T_C}{T} \right)$$

$$T_D \leq T \quad S_e(T) = a_g \cdot S \cdot \eta \cdot F_o \cdot \left(\frac{T_C T_D}{T^2} \right)$$

Lo spettro di progetto $S_d(T)$ per le verifiche agli Stati Limite Ultimi è ottenuto dalle espressioni dello spettro elastico $S_e(T)$ sostituendo η con $1/q$, dove q è il fattore di struttura. (NTC-08 § 3.2.3.5)

Punti dello spettro di risposta

	T [s]	Se [g]
	0.000	0.240
$T_B \leftarrow$	0.132	0.606
$T_C \leftarrow$	0.396	0.606
	0.491	0.488
	0.587	0.408
	0.682	0.351
	0.778	0.308
	0.873	0.274
	0.969	0.247
	1.064	0.225
	1.160	0.207
	1.255	0.191
	1.351	0.177
	1.446	0.166
	1.542	0.155
	1.637	0.146
	1.733	0.138
	1.828	0.131
	1.924	0.125
	2.019	0.119
	2.115	0.113
	2.210	0.108
	2.306	0.104
$T_D \leftarrow$	2.401	0.100
	2.477	0.094
	2.554	0.088
	2.630	0.083
	2.706	0.079
	2.782	0.074
	2.858	0.070
	2.934	0.067
	3.010	0.063
	3.086	0.060
	3.163	0.058
	3.239	0.055
	3.315	0.052
	3.391	0.050
	3.467	0.048
	3.543	0.046
	3.619	0.044
	3.695	0.042
	3.772	0.040
	3.848	0.040
	3.924	0.040
	4.000	0.040

Parametri e punti dello spettro di risposta verticale per lo stato limite: SLV

Parametri indipendenti

STATO LIMITE	SLV
a_{qv}	0.121 g
S_S	1.000
S_T	1.000
q	1.000
T_B	0.050 s
T_C	0.150 s
T_D	1.000 s

Parametri dipendenti

F_v	1.525
S	1.000
η	1.000

Espressioni dei parametri dipendenti

$$S = S_S \cdot S_T \quad (\text{NTC-08 Eq. 3.2.5})$$

$$\eta = 1/q \quad (\text{NTC-08 §. 3.2.3.5})$$

$$F_v = 1,35 \cdot F_o \cdot \left(\frac{a_g}{g} \right)^{0,5} \quad (\text{NTC-08 Eq. 3.2.11})$$

Espressioni dello spettro di risposta (NTC-08 Eq. 3.2.10)

$$0 \leq T < T_B \quad S_e(T) = a_g \cdot S \cdot \eta \cdot F_v \cdot \left[\frac{T}{T_B} + \frac{1}{\eta \cdot F_o} \left(1 - \frac{T}{T_B} \right) \right]$$

$$T_B \leq T < T_C \quad S_e(T) = a_g \cdot S \cdot \eta \cdot F_v$$

$$T_C \leq T < T_D \quad S_e(T) = a_g \cdot S \cdot \eta \cdot F_v \cdot \left(\frac{T_C}{T} \right)$$

$$T_D \leq T \quad S_e(T) = a_g \cdot S \cdot \eta \cdot F_v \cdot \left(\frac{T_C T_D}{T^2} \right)$$

Punti dello spettro di risposta

	T [s]	Se [g]
	0.000	0.121
$T_B \leftarrow$	0.050	0.305
$T_C \leftarrow$	0.150	0.305
	0.235	0.195
	0.320	0.143
	0.405	0.113
	0.490	0.094
	0.575	0.080
	0.660	0.069
	0.745	0.062
	0.830	0.055
	0.915	0.050
$T_D \leftarrow$	1.000	0.046
	1.094	0.038
	1.188	0.032
	1.281	0.028
	1.375	0.024
	1.469	0.021
	1.563	0.019
	1.656	0.017
	1.750	0.015
	1.844	0.013
	1.938	0.012
	2.031	0.011
	2.125	0.010
	2.219	0.009
	2.313	0.009
	2.406	0.008
	2.500	0.007
	2.594	0.007
	2.688	0.006
	2.781	0.006
	2.875	0.006
	2.969	0.005
	3.063	0.005
	3.156	0.005
	3.250	0.004
	3.344	0.004
	3.438	0.004
	3.531	0.004
	3.625	0.003
	3.719	0.003
	3.813	0.003
	3.906	0.003
	4.000	0.003

Spettri di risposta (componenti orizz. e vert.) per lo stato limite: SLV

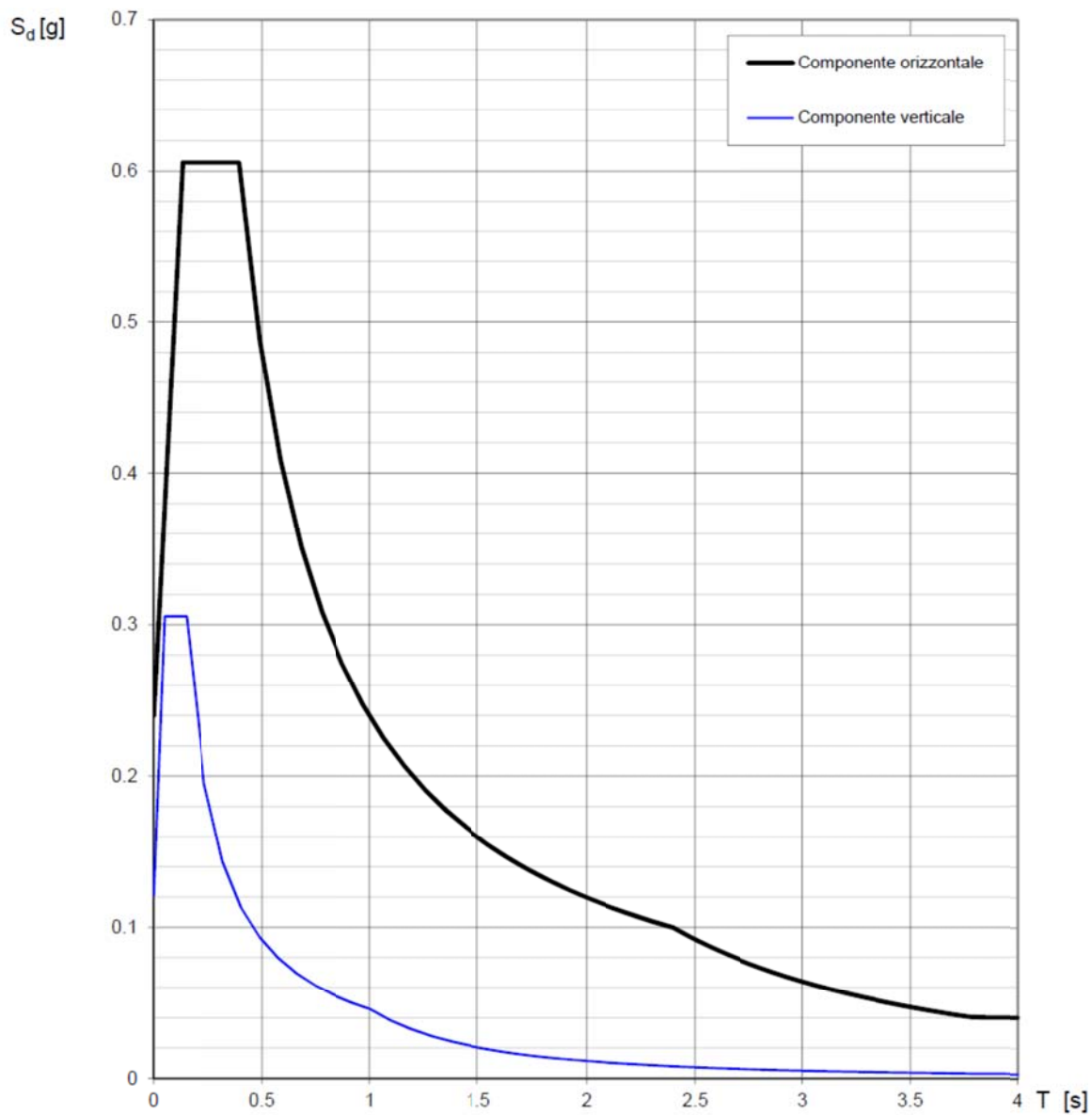

Parametri e punti dello spettro di risposta orizzontale per lo stato limite: SLD

Parametri indipendenti

STATO LIMITE	SLD
a_g	0.096 g
F_o	2.427
T_C	0.250 s
S_S	1.200
C_C	1.451
S_T	1.000
q	1.000

Parametri dipendenti

S	1.200
η	1.000
T_B	0.121 s
T_C	0.363 s
T_D	1.983 s

Espressioni dei parametri dipendenti

$$S = S_S \cdot S_T \quad (\text{NTC-08 Eq. 3.2.5})$$

$$\eta = \sqrt{10/(5 + \xi)} \geq 0,55; \quad \eta = 1/q \quad (\text{NTC-08 Eq. 3.2.6; §. 3.2.3.5})$$

$$T_B = T_C / 3 \quad (\text{NTC-07 Eq. 3.2.8})$$

$$T_C = C_C \cdot T_C^* \quad (\text{NTC-07 Eq. 3.2.7})$$

$$T_D = 4,0 \cdot a_g / g + 1,6 \quad (\text{NTC-07 Eq. 3.2.9})$$

Espressioni dello spettro di risposta (NTC-08 Eq. 3.2.4)

$$0 \leq T < T_B \quad S_e(T) = a_g \cdot S \cdot \eta \cdot F_o \cdot \left[\frac{T}{T_B} + \frac{1}{\eta \cdot F_o} \left(1 - \frac{T}{T_B} \right) \right]$$

$$T_B \leq T < T_C \quad S_e(T) = a_g \cdot S \cdot \eta \cdot F_o$$

$$T_C \leq T < T_D \quad S_e(T) = a_g \cdot S \cdot \eta \cdot F_o \cdot \left(\frac{T_C}{T} \right)$$

$$T_D \leq T \quad S_e(T) = a_g \cdot S \cdot \eta \cdot F_o \cdot \left(\frac{T_C T_D}{T^2} \right)$$

Lo spettro di progetto $S_d(T)$ per le verifiche agli Stati Limite Ultimi è ottenuto dalle espressioni dello spettro elastico $S_e(T)$ sostituendo η con $1/q$, dove q è il fattore di struttura. (NTC-08 § 3.2.3.5)

Punti dello spettro di risposta

	T [s]	Se [g]
	0.000	0.115
$T_B \leftarrow$	0.121	0.278
$T_C \leftarrow$	0.363	0.278
	0.440	0.230
	0.518	0.196
	0.595	0.170
	0.672	0.151
	0.749	0.135
	0.826	0.123
	0.903	0.112
	0.980	0.103
	1.057	0.096
	1.134	0.089
	1.212	0.084
	1.289	0.079
	1.366	0.074
	1.443	0.070
	1.520	0.067
	1.597	0.063
	1.674	0.060
	1.751	0.058
	1.828	0.055
	1.905	0.053
$T_D \leftarrow$	1.983	0.051
	2.079	0.046
	2.175	0.042
	2.271	0.039
	2.367	0.036
	2.463	0.033
	2.559	0.031
	2.655	0.028
	2.751	0.027
	2.847	0.025
	2.943	0.023
	3.039	0.022
	3.135	0.020
	3.231	0.019
	3.328	0.018
	3.424	0.017
	3.520	0.016
	3.616	0.015
	3.712	0.015
	3.808	0.014
	3.904	0.013
	4.000	0.013

Parametri e punti dello spettro di risposta verticale per lo stato limite: SLD

Parametri indipendenti

STATO LIMITE	SLD
a_{qv}	0.040 g
S_S	1.000
S_T	1.000
q	1.000
T_B	0.050 s
T_C	0.150 s
T_D	1.000 s

Parametri dipendenti

F_v	1.013
S	1.000
η	1.000

Espressioni dei parametri dipendenti

$$S = S_S \cdot S_T \quad (\text{NTC-08 Eq. 3.2.5})$$

$$\eta = 1/q \quad (\text{NTC-08 §. 3.2.3.5})$$

$$F_v = 1,35 \cdot F_0 \cdot \left(\frac{a_g}{g}\right)^{0,5} \quad (\text{NTC-08 Eq. 3.2.11})$$

Espressioni dello spettro di risposta (NTC-08 Eq. 3.2.10)

$$0 \leq T < T_B \quad S_e(T) = a_g \cdot S \cdot \eta \cdot F_v \cdot \left[\frac{T}{T_B} + \frac{1}{\eta F_0} \left(1 - \frac{T}{T_B} \right) \right]$$

$$T_B \leq T < T_C \quad S_e(T) = a_g \cdot S \cdot \eta \cdot F_v$$

$$T_C \leq T < T_D \quad S_e(T) = a_g \cdot S \cdot \eta \cdot F_v \cdot \left(\frac{T_C}{T} \right)$$

$$T_D \leq T \quad S_e(T) = a_g \cdot S \cdot \eta \cdot F_v \cdot \left(\frac{T_C T_D}{T^2} \right)$$

Punti dello spettro di risposta

	T [s]	Se [g]
	0.000	0.040
$T_B \leftarrow$	0.050	0.097
$T_C \leftarrow$	0.150	0.097
	0.235	0.062
	0.320	0.045
	0.405	0.036
	0.490	0.030
	0.575	0.025
	0.660	0.022
	0.745	0.020
	0.830	0.018
	0.915	0.016
$T_D \leftarrow$	1.000	0.015
	1.094	0.012
	1.188	0.010
	1.281	0.009
	1.375	0.008
	1.469	0.007
	1.563	0.006
	1.656	0.005
	1.750	0.005
	1.844	0.004
	1.938	0.004
	2.031	0.004
	2.125	0.003
	2.219	0.003
	2.313	0.003
	2.406	0.003
	2.500	0.002
	2.594	0.002
	2.688	0.002
	2.781	0.002
	2.875	0.002
	2.969	0.002
	3.063	0.002
	3.156	0.001
	3.250	0.001
	3.344	0.001
	3.438	0.001
	3.531	0.001
	3.625	0.001
	3.719	0.001
	3.813	0.001
	3.906	0.001
	4.000	0.001

Spettri di risposta (componenti orizz. e vert.) per lo stato limite: SLD

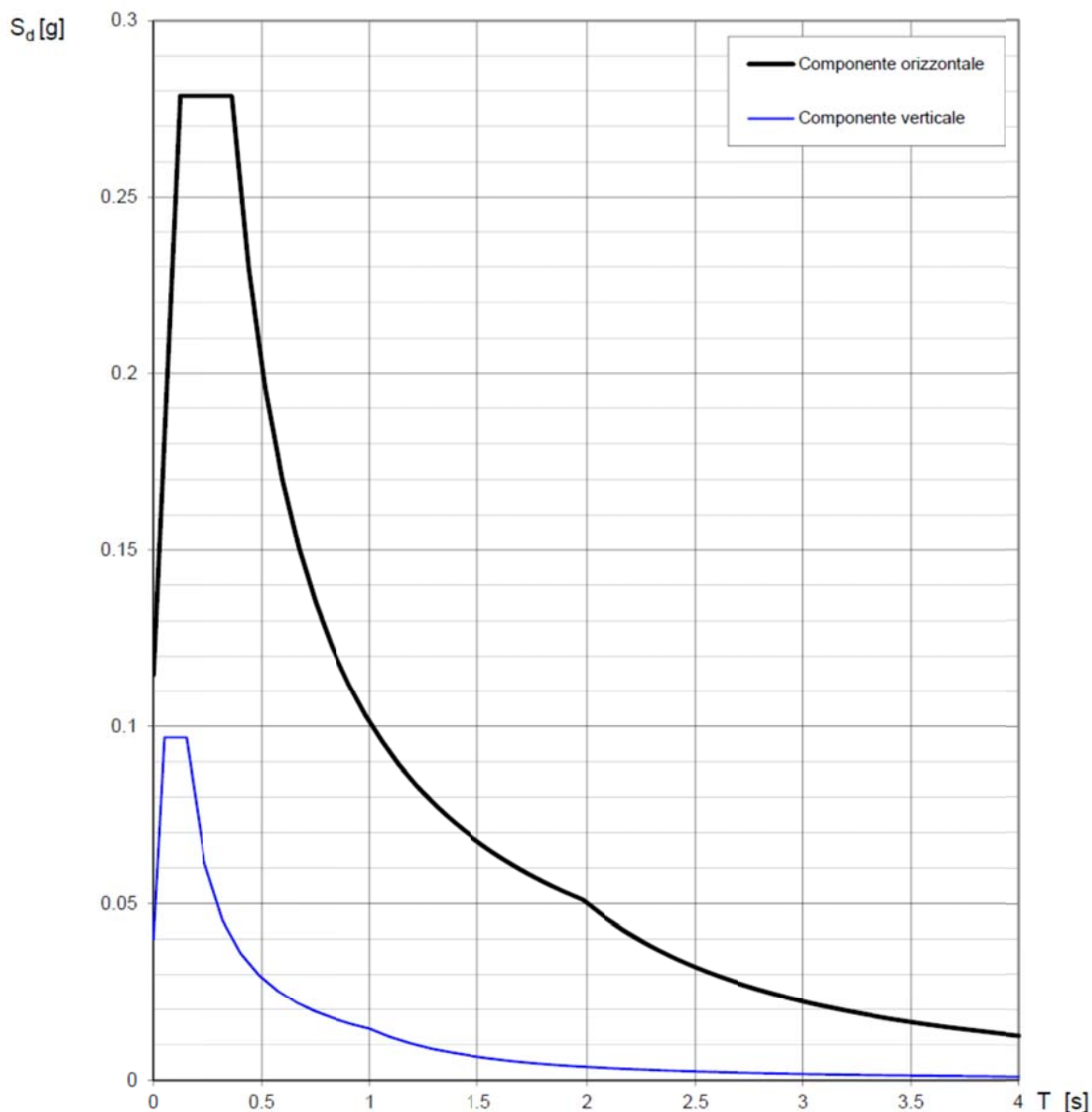

Lo stato di sollecitazione e di deformazione indotto dal sisma è stato indagato facendo ricorso ad un'analisi dinamica lineare a spettro della struttura.

Ai fini delle verifiche, sono state considerate le seguenti combinazioni degli effetti delle componenti sismiche permutando i coefficienti di combinazione ed i segni (E_x definisce gli effetti della componente orizzontale dell'azione sismica agente secondo la direzione x, E_y gli effetti della componente orizzontale agente secondo la direzione y, E_z gli effetti della componente verticale agente secondo la direzione z).

$$\pm E_x \pm 0.3 \cdot E_y \pm 0.3 \cdot E_z$$

$$\pm E_y \pm 0.3 \cdot E_x \pm 0.3 \cdot E_z$$

$$\pm E_z \pm 0.3 \cdot E_x \pm 0.3 \cdot E_y$$

6. Modellazione della struttura

Nel seguito si riportano le peculiarità della modellazione relativa al ponte strallato. A tal proposito sono stati implementati due modelli di calcolo FEM, uno relativo all'intera struttura ed un modello parziale della piastra ortotropa superiore per poter valutare gli effetti locali.

6.1 Descrizione del modello di calcolo

I modelli sono stati implementati con il software "MIDAS GEN 2011 (v2.1)", prodotto da Midas Information Technology Co., Ltd (Corea). I risultati ottenuti sono stati validati con verifiche manuali e confronti con risultati ottenuti su modelli semplificati. I tabulati di calcolo comprensivi della descrizione completa del modello, e dei risultati dell'analisi per sollecitazioni e deformazioni, vengono forniti in allegato.

Nel modello globale le pile laterali sono state modellate mediante elementi monodimensionale tipo *beam* a sezione piena ottagonale incastrate alla base. La pila centrale è stata modellata con elementi *shell* con rigidezza membranale e flessionale e con spessori variabili, mentre le aste dell'antenna sono state modellate con elementi *beam* con la reale geometria ovvero le aste in c.a. hanno sezioni variabili linearmente con l'altezza come da grafici. Per tale pila centrale non si è considerato un vincolo di incastro alla base ma si è modellata la piastra di fondazione con elementi *shell* poggianti su molle elastiche concentrate in corrispondenza dei pali di fondazione. Anche l'impalcato è modellato con elementi monodimensionale di tipo *beam* per la trave a cassone longitudinale, il tubo e i traversi a cui sono state attribuite le caratteristiche geometriche ed inerziali della sezione trasversale in acciaio. Completano il modello, gli stralli che sono stati modellati con elementi *truss* reagenti solo a sforzo normale.

Nel modello parziale della piastra ortotropa si sono implementate due porzioni della piastra superiore poste a cavallo di un traverso mediante elementi *shell*. Tali elementi portano in conto la reale geometria della piastra nervata e pertanto anche gli irrigidimenti longitudinali trapezi ed a L così come le traverse sono state modellate con elementi *shell* con la reale geometria. Il modello è stato vincolato in corrispondenza dei nodi ricadenti sulle anime e sui traversi, sia mediante vincoli di tipo incastro che di tipo cerniera, essendo il reale comportamento dei vincoli offerti dalle piastre di anime e traversi intermedi tra i due casi limite considerati.

Si riportano di seguito alcune immagini rappresentative dei modelli di calcolo.



Figura 20 – Vista 3D del modello di calcolo globale



Figura 21 – Prospetto frontale della pila-antenna

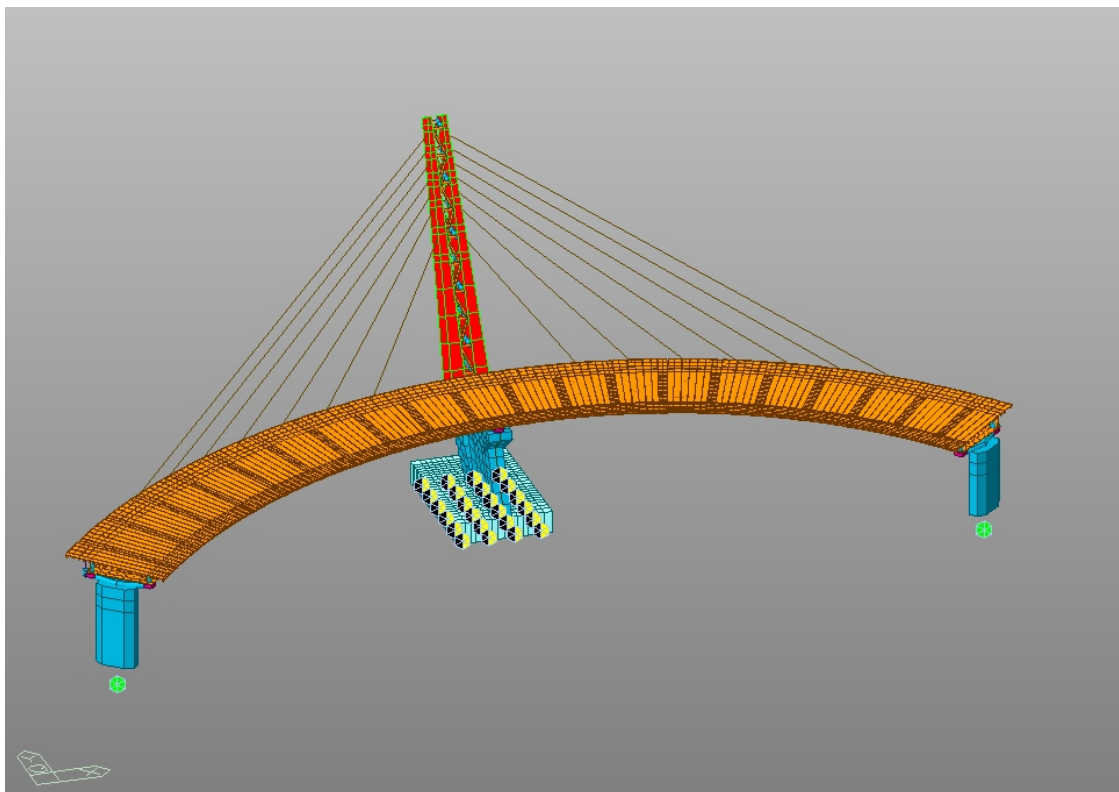

Figura 22 – Prospetto laterale della pila-antenna

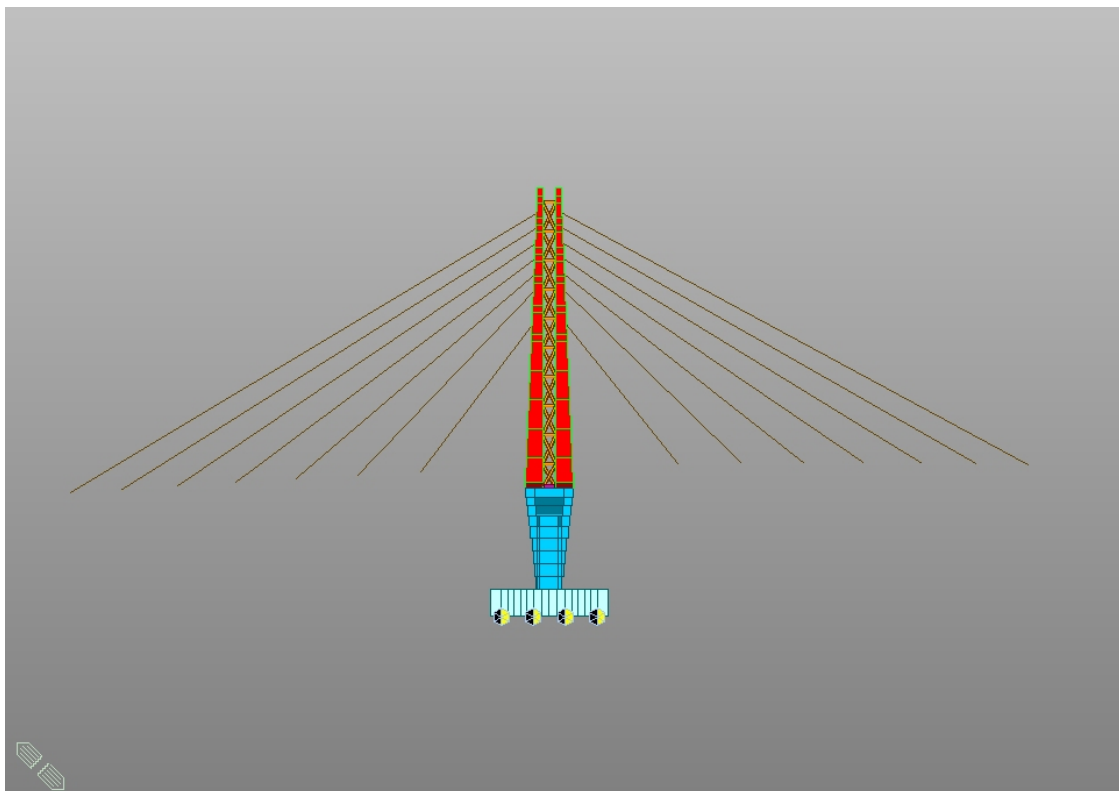

Figura 23 – Sezione impalcato in acciaio

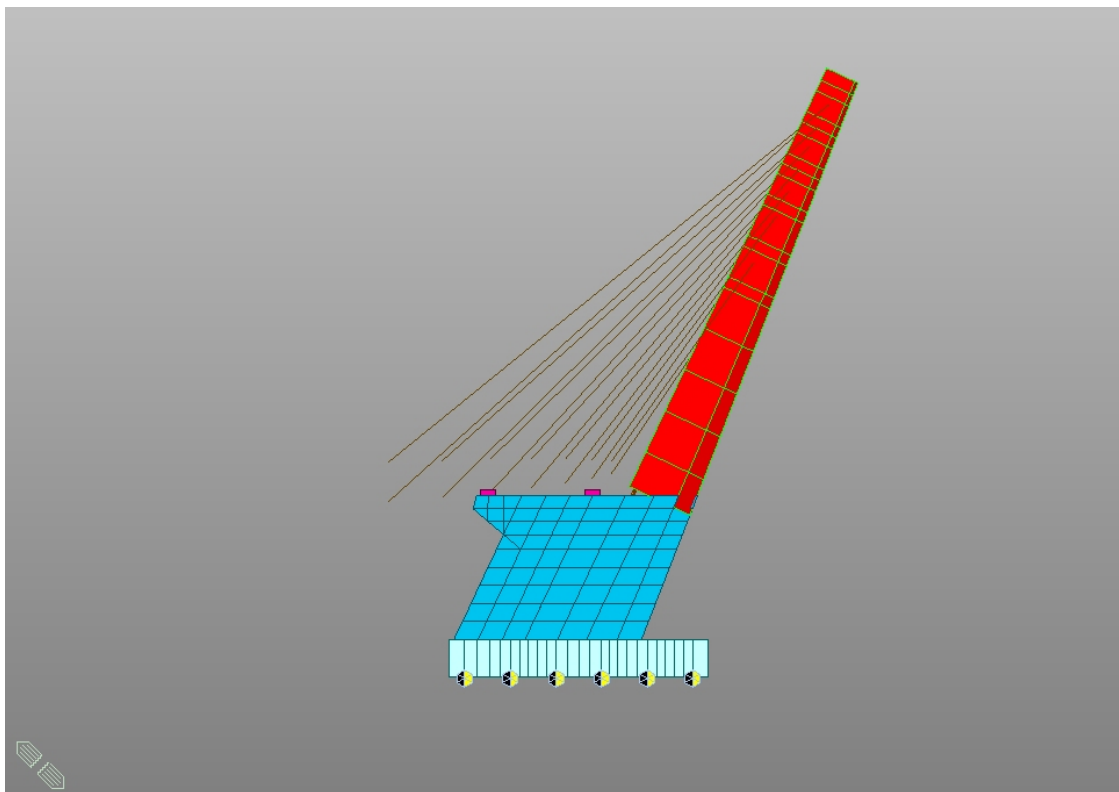

Figura 24 – Modello parziale piastra ortotropa superiore

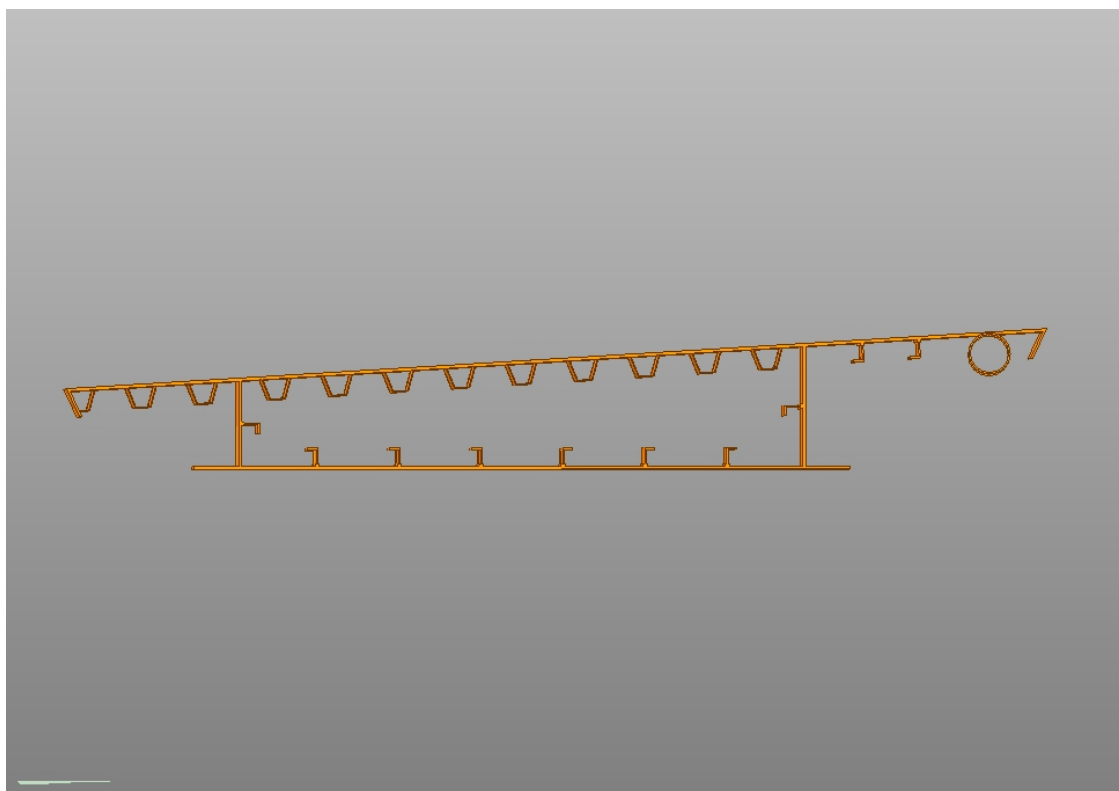

Figura 25 – Modello parziale piastra ortotropa superiore: schema dei vincoli adottati

7. Azioni sulle strutture

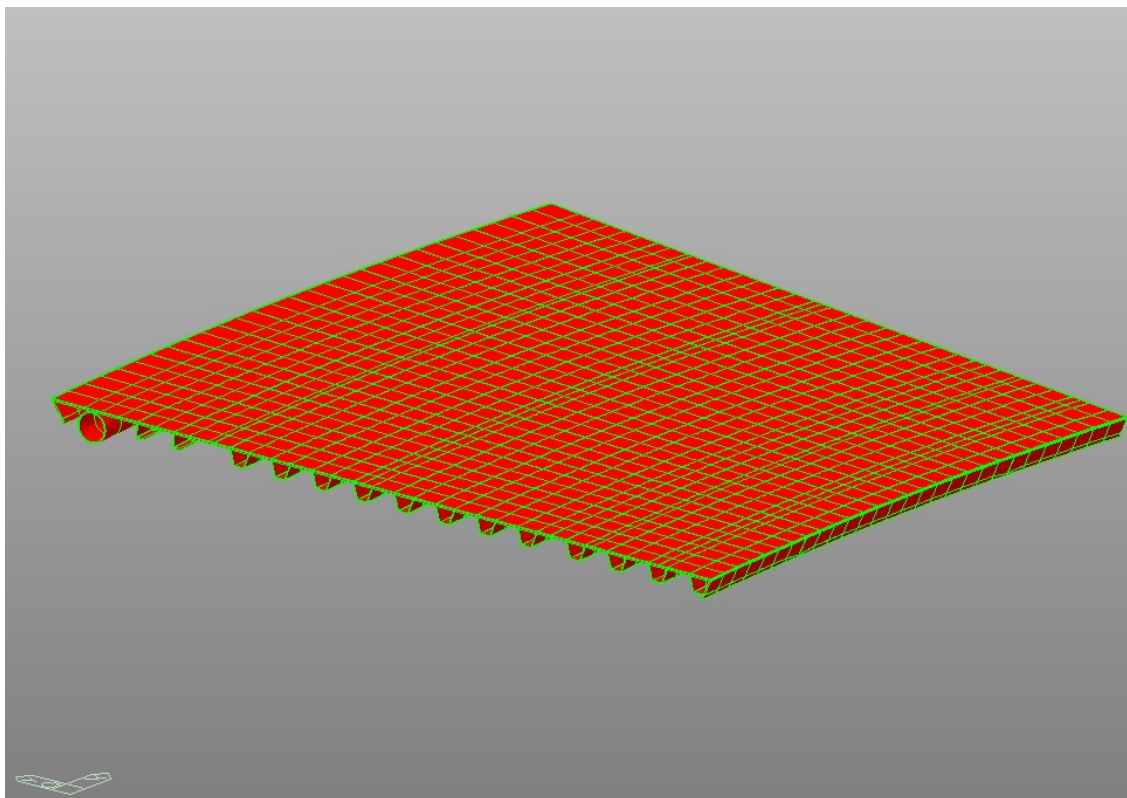
I modelli implementati sono stati caricati con forze distribuite e concentrate in corrispondenza degli impalcati per modellare le azioni gravitazionali (peso proprio, carichi permanenti e carichi mobili secondo le diverse distribuzioni previste) e le azioni orizzontali (forze di frenamento, azione centrifuga, forze dovute all'attrito, azione del vento e azione del sisma).

Inoltre sono stati considerati i carichi termici di progetto sugli elementi e gli effetti reologici del calcestruzzo dell'antenna. Per quanto riguarda le azioni sismiche si è eseguita una analisi lineare dinamica con spettro di risposta in termini di accelerazione. Le masse considerate sono tutte quelle nodali derivanti dai carichi permanenti di progetto e si sono considerati un numero sufficienti di modi di vibrazione per attivare almeno l'85% della massa agente. I modi di vibrare e quindi gli effetti sono combinati secondo la CQC.

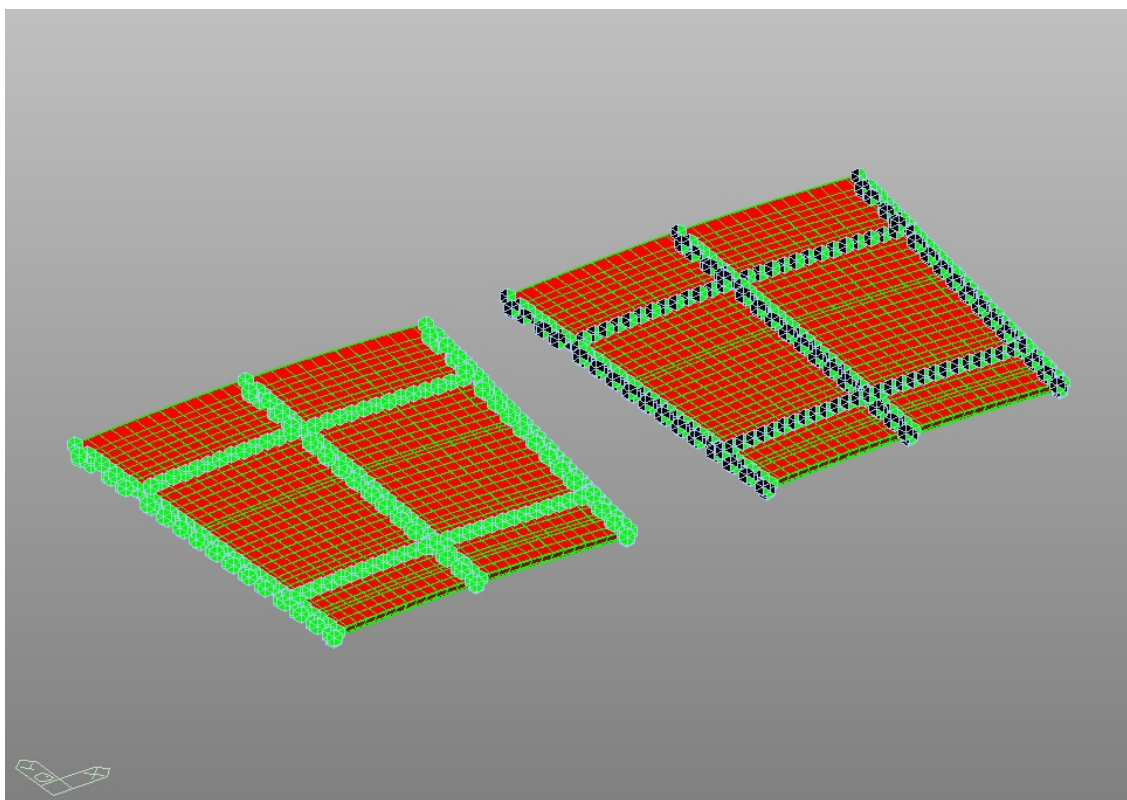
7.1 Condizioni elementari di carico

In base alla modellazione delle azioni adottata, sono state considerate le seguenti condizioni elementari di carico:

G1 = peso proprio strutture

G2 = carichi permanenti

Q1 = azioni variabili da traffico veicolare

q3 = azione di frenamento

q4 = azione centrifuga

q5,pc = azione del vento a ponte carico

q5,ps = azione del vento a ponte scarico

q7 = attrito ai vincoli

T = variazioni termiche uniformi

DT = variazioni termiche a farfalla

P = pretensione stralli

N = carico da neve

Creep = viscosità del cls dell'antenna

Shrinkage = ritiro del cls dell'antenna

SLV_x, SLD_x = azione sismica orizzontale nella direzione x

SLV_y, SLD_y = azione sismica orizzontale nella direzione y

SLV_z, SLD_z = azione sismica in direzione verticale

Nel seguito della presente, si riportano le diverse combinazioni di carico adottate in relazione allo stato limite considerato.

7.2 Combinazioni delle azioni agli Stati Limite

In base alla vigente normativa, per la definizione delle azioni di calcolo agli stati limite ultimi, a partire dalle condizioni di carico elementari, sono state considerate le seguenti combinazioni delle azioni:

- *Combinazioni delle azioni per le verifiche agli stati limite ultimi* secondo lo schema indicato in tabella 5.1.IV delle “Norme tecniche per le costruzioni” di cui al D.M. 14.01.2008:

$$F_d = \gamma_{g1} \cdot G_1 + \gamma_{g2} \cdot G_2 + \gamma_{Q1} \cdot Q_{k1} + \sum_{i=2}^n (\gamma_{Qi} \cdot \psi_{0i} \cdot Q_{ki})$$

- *Combinazione sismica:*

$$F_d = E + G_1 + G_2 + \sum_{i=1}^n (\psi_{2i} \cdot Q_{ki})$$

avendo assunto per i coefficienti $\gamma_{g,1}$, $\gamma_{g,2}$ e $\gamma_{q,i}$ e per i coefficienti di combinazione Ψ_{0i} , Ψ_{1i} e Ψ_{2i} i valori previsti dalle norme e riportati rispettivamente nelle tabella 2.5.V e 2.5.VI delle “Norme tecniche per le costruzioni” di cui al D.M. 14.01.2008.

Si riporta di seguito un riepilogo delle combinazioni delle azioni allo stato limite ultimo e di esercizio considerate nelle analisi strutturali:

LIST OF LOAD COMBINATIONS					
NUM	NAME	ACTIVE LOADCASE (FACTOR) +	TYPE	LOADCASE (FACTOR) +	LOADCASE (FACTOR)
1	G1	Active G1(1.000)	Add		
2	G2	Active G2(1.000) +	Add	G2t(1.000)	
3	G1+G2	Active G1(1.000) +	Add	G2(1.000)	
4	G1+G2+P	Active G1(1.000) +	Add	G2(1.000) +	P(1.000)
5	Q1k	Active Q1a(1.000) +	Envelope	Q1b(1.000) +	Q1s(1.000)
6	Q2f	Active Q2a(1.000) +	Envelope	Q2b(1.000)	
7	q4	Active q4-1(1.000) +	Envelope	q4-2(1.000) +	q4-3(1.000)
8	Q2a	Active q3(1.000) +	Add	Q2f(1.000)	
9	Q2b	Active q4(1.000) +	Add	Q2f(1.000)	
10	SLU-1	Active G1(1.350) + q5x_pc(0.900) +	Add	G2(1.350) + P(1.000) +	T(0.720) Q1k(1.350)
11	SLU-2	Active q5x_pc(0.900) + G2(1.350) +	Add	T(-0.720) + P(1.000) +	G1(1.350) Q1k(1.350)
12	SLU-3	Active q5x_pc(-0.900) + G2(1.350) +	Add	T(-0.720) + P(1.000) +	G1(1.350) Q1k(1.350)
13	SLU-4	Active	Add		

Sovrapasso di ingresso - Ponte strallato - Relazione di calcolo

		q5x_pc(-0.900) + G2(1.350) +		T(0.720) + P(1.000) +	G1(1.350) Q1k(1.350)
14	SLU-5	Active G1(1.350) + q5y_pc(0.900) +	Add	G2(1.350) + P(1.000) +	T(0.720) Q1k(1.350)
15	SLU-6	Active q5y_pc(0.900) + G2(1.350) +	Add	T(-0.720) + P(1.000) +	G1(1.350) Q1k(1.350)
16	SLU-7	Active q5y_pc(-0.900) + G2(1.350) +	Add	T(-0.720) + P(1.000) +	G1(1.350) Q1k(1.350)
17	SLU-8	Active q5y_pc(-0.900) + G2(1.350) +	Add	T(0.720) + P(1.000) +	G1(1.350) Q1k(1.350)
18	SLU-9	Active q5x_pc(0.900) + G2(1.350) +	Add	T(0.720) + Q2a(1.350) +	G1(1.350) P(1.000)
19	SLU-10	Active q5x_pc(0.900) + G2(1.350) +	Add	T(-0.720) + Q2a(1.350) +	G1(1.350) P(1.000)
20	SLU-11	Active q5x_pc(-0.900) + G2(1.350) +	Add	T(-0.720) + Q2a(1.350) +	G1(1.350) P(1.000)
21	SLU-12	Active q5x_pc(-0.900) + G2(1.350) +	Add	T(0.720) + Q2a(1.350) +	G1(1.350) P(1.000)
22	SLU-13	Active q5y_pc(0.900) + G2(1.350) +	Add	T(0.720) + Q2a(1.350) +	G1(1.350) P(1.000)
23	SLU-14	Active q5y_pc(0.900) + G2(1.350) +	Add	T(-0.720) + Q2a(1.350) +	G1(1.350) P(1.000)
24	SLU-15	Active q5y_pc(-0.900) + G2(1.350) +	Add	T(-0.720) + Q2a(1.350) +	G1(1.350) P(1.000)
25	SLU-16	Active q5y_pc(-0.900) + G2(1.350) +	Add	T(0.720) + Q2a(1.350) +	G1(1.350) P(1.000)
26	SLU-17	Active q5x_pc(0.900) + G2(1.350) +	Add	T(0.720) + Q2b(1.350) +	G1(1.350) P(1.000)
27	SLU-18	Active q5x_pc(0.900) + G2(1.350) +	Add	T(-0.720) + Q2b(1.350) +	G1(1.350) P(1.000)
28	SLU-19	Active q5x_pc(-0.900) + G2(1.350) +	Add	T(-0.720) + Q2b(1.350) +	G1(1.350) P(1.000)
29	SLU-20	Active q5x_pc(-0.900) + G2(1.350) +	Add	T(0.720) + Q2b(1.350) +	G1(1.350) P(1.000)
30	SLU-21	Active q5y_pc(0.900) + G2(1.350) +	Add	T(0.720) + Q2b(1.350) +	G1(1.350) P(1.000)
31	SLU-22	Active q5y_pc(0.900) + G2(1.350) +	Add	T(-0.720) + Q2b(1.350) +	G1(1.350) P(1.000)
32	SLU-23	Active q5y_pc(-0.900) + G2(1.350) +	Add	T(-0.720) + Q2b(1.350) +	G1(1.350) P(1.000)
33	SLU-24	Active q5y_pc(-0.900) + G2(1.350) +	Add	T(0.720) + Q2b(1.350) +	G1(1.350) P(1.000)
34	SLU-25	Active q5x_ps(1.500) + G2(1.350) +	Add	T(0.720) + P(1.000)	G1(1.350)
35	SLU-26	Active q5x_ps(1.500) + G2(1.350) +	Add	T(-0.720) + P(1.000)	G1(1.350)
36	SLU-27	Active q5x_ps(-1.500) + G2(1.350) +	Add	T(-0.720) + P(1.000)	G1(1.350)
37	SLU-28	Active q5x_ps(-1.500) + G2(1.350) +	Add	T(0.720) + P(1.000)	G1(1.350)
38	SLU-29	Active	Add		

Sovrapasso di ingresso - Ponte strallato - Relazione di calcolo

		q5y_ps(1.500) + G2(1.350) +		T(0.720) + P(1.000)	G1(1.350)
39	SLU-30	Active q5y_ps(1.500) + G2(1.350) +	Add	T(-0.720) + P(1.000)	G1(1.350)
40	SLU-31	Active q5y_ps(-1.500) + G2(1.350) +	Add	T(-0.720) + P(1.000)	G1(1.350)
41	SLU-32	Active q5y_ps(-1.500) + G2(1.350) +	Add	T(0.720) + P(1.000)	G1(1.350)
42	SLU-33	Active q5x_pc(0.900) + G2(1.350) +	Add	T(1.200) + P(1.000)	G1(1.350)
43	SLU-34	Active q5x_pc(0.900) + G2(1.350) +	Add	T(-1.200) + P(1.000)	G1(1.350)
44	SLU-35	Active q5x_pc(-0.900) + G2(1.350) +	Add	T(-1.200) + P(1.000)	G1(1.350)
45	SLU-36	Active q5x_pc(-0.900) + G2(1.350) +	Add	T(1.200) + P(1.000)	G1(1.350)
46	SLU-37	Active q5y_pc(0.900) + G2(1.350) +	Add	T(1.200) + P(1.000)	G1(1.350)
47	SLU-38	Active q5y_pc(0.900) + G2(1.350) +	Add	T(-1.200) + P(1.000)	G1(1.350)
48	SLU-39	Active q5y_pc(-0.900) + G2(1.350) +	Add	T(-1.200) + P(1.000)	G1(1.350)
49	SLU-40	Active q5y_pc(-0.900) + G2(1.350) +	Add	T(1.200) + P(1.000)	G1(1.350)
50	SLU-41	Active q5x_pc(0.900) + G2(1.350) +	Add	DT(1.200) + P(1.000)	G1(1.350)
51	SLU-42	Active q5x_pc(0.900) + G2(1.350) +	Add	DT(-1.200) + P(1.000)	G1(1.350)
52	SLU-43	Active q5x_pc(-0.900) + G2(1.350) +	Add	DT(-1.200) + P(1.000)	G1(1.350)
53	SLU-44	Active q5x_pc(-0.900) + G2(1.350) +	Add	DT(1.200) + P(1.000)	G1(1.350)
54	SLU-45	Active q5y_pc(0.900) + G2(1.350) +	Add	DT(1.200) + P(1.000)	G1(1.350)
55	SLU-46	Active q5y_pc(0.900) + G2(1.350) +	Add	DT(-1.200) + P(1.000)	G1(1.350)
56	SLU-47	Active q5y_pc(-0.900) + G2(1.350) +	Add	DT(-1.200) + P(1.000)	G1(1.350)
57	SLU-48	Active q5y_pc(-0.900) + G2(1.350) +	Add	DT(1.200) + P(1.000)	G1(1.350)
58	SLU-49	Active G1(1.000) + q5y_pc(0.900) +	Add	G2(1.000) + P(1.000)	DT(1.200)
59	SLU-50	Active G1(1.000) + q5y_pc(0.900) +	Add	G2(1.000) + P(1.000)	DT(-1.200)
60	SLU-51	Active G1(1.000) + q5y_pc(-0.900) +	Add	G2(1.000) + P(1.000)	DT(-1.200)
61	SLU-52	Active G1(1.000) + q5y_pc(-0.900) +	Add	G2(1.000) + P(1.000)	DT(1.200)
62	SLU-53	Active G1(1.000) + G2(1.000) +	Add	T(0.720) + P(1.000) +	q5y_pc(0.900) Q1k(1.350)
63	SLU-54	Active	Add		

Sovrapasso di ingresso - Ponte strallato - Relazione di calcolo

		G1(1.000) + q5y_pc(0.900) +		Q2a(1.350) + G2(1.000) +	T(0.720) P(1.000)
64	SLU-55	Active	Add		
		G1(1.000) + q5y_pc(0.900) +		Q2b(1.350) + G2(1.000) +	T(0.720) P(1.000)
65	SLU-56	Active	Add		
		G1(1.000) + q5y_pc(1.500) +		G2(1.000) + P(1.000)	T(0.720)
66	SLU-57	Active	Add		
		G1(1.000) + q5y_pc(1.500) +		G2(1.000) + P(1.000)	T(-0.720)
67	SLU-58	Active	Add		
		G1(1.000) + q5y_pc(-1.500) +		G2(1.000) + P(1.000)	T(-0.720)
68	SLU-59	Active	Add		
		G1(1.000) + q5y_pc(-1.500) +		G2(1.000) + P(1.000)	T(0.720)
69	SLU-60	Active	Add		
		G1(1.000) + q5y_pc(0.900) +		G2(1.000) + P(1.000)	T(1.200)
70	SLU-61	Active	Add		
		G1(1.000) + q5y_pc(0.900) +		G2(1.000) + P(1.000)	T(-1.200)
71	SLU-62	Active	Add		
		G1(1.000) + q5y_pc(-0.900) +		G2(1.000) + P(1.000)	T(-1.200)
72	SLU-63	Active	Add		
		G1(1.000) + q5y_pc(-0.900) +		G2(1.000) + P(1.000)	T(1.200)
73	SLV1x	Active	Add		
		G1+G2+P(1.000) + SLVz(0.300)		SLVx(1.000) +	SLVy(0.300)
74	SLV2x	Active	Add		
		G1+G2+P(1.000) + SLVz(0.300)		SLVx(1.000) +	SLVy(-0.300)
75	SLV3x	Active	Add		
		G1+G2+P(1.000) + SLVz(-0.300)		SLVx(1.000) +	SLVy(0.300)
76	SLV4x	Active	Add		
		G1+G2+P(1.000) + SLVz(-0.300)		SLVx(1.000) +	SLVy(-0.300)
77	SLV5x	Active	Add		
		G1+G2+P(1.000) + SLVz(0.300)		SLVx(-1.000) +	SLVy(0.300)
78	SLV6x	Active	Add		
		G1+G2+P(1.000) + SLVz(0.300)		SLVx(-1.000) +	SLVy(-0.300)
79	SLV7x	Active	Add		
		G1+G2+P(1.000) + SLVz(-0.300)		SLVx(-1.000) +	SLVy(0.300)
80	SLV8x	Active	Add		
		G1+G2+P(1.000) + SLVz(-0.300)		SLVx(-1.000) +	SLVy(-0.300)
81	SLV1y	Active	Add		
		G1+G2+P(1.000) + SLVz(0.300)		SLVy(1.000) +	SLVx(0.300)
82	SLV2y	Active	Add		
		G1+G2+P(1.000) + SLVz(0.300)		SLVy(1.000) +	SLVx(-0.300)
83	SLV3y	Active	Add		
		G1+G2+P(1.000) + SLVz(-0.300)		SLVy(1.000) +	SLVx(0.300)
84	SLV4y	Active	Add		
		G1+G2+P(1.000) + SLVz(-0.300)		SLVy(1.000) +	SLVx(-0.300)
85	SLV5y	Active	Add		
		G1+G2+P(1.000) + SLVz(0.300)		SLVy(-1.000) +	SLVx(0.300)
86	SLV6y	Active	Add		
		G1+G2+P(1.000) + SLVz(0.300)		SLVy(-1.000) +	SLVx(-0.300)
87	SLV7y	Active	Add		
		G1+G2+P(1.000) + SLVz(-0.300)		SLVy(-1.000) +	SLVx(0.300)
88	SLV8y	Active	Add		

Sovrapasso di ingresso - Ponte strallato - Relazione di calcolo

		G1+G2+P(1.000) + SLVz(-0.300)		SLVy(-1.000) +		SLVx(-0.300)
89	SLV1z	Active G1+G2+P(1.000) + SLVy(0.300)	Add			SLVx(0.300)
90	SLV2z	Active G1+G2+P(1.000) + SLVy(0.300)	Add		SLVz(1.000) +	SLVx(-0.300)
91	SLV3z	Active G1+G2+P(1.000) + SLVy(-0.300)	Add		SLVz(1.000) +	SLVx(0.300)
92	SLV4z	Active G1+G2+P(1.000) + SLVy(-0.300)	Add		SLVz(1.000) +	SLVx(-0.300)
93	SLV5z	Active G1+G2+P(1.000) + SLVy(0.300)	Add		SLVz(-1.000) +	SLVx(0.300)
94	SLV6z	Active G1+G2+P(1.000) + SLVy(0.300)	Add		SLVz(-1.000) +	SLVx(-0.300)
95	SLV7z	Active G1+G2+P(1.000) + SLVy(-0.300)	Add		SLVz(-1.000) +	SLVx(0.300)
96	SLV8z	Active G1+G2+P(1.000) + SLVy(-0.300)	Add		SLVz(-1.000) +	SLVx(-0.300)
97	SLR-1	Active G1(1.000) + T(0.600) +	Add	G2(1.000) + P(1.000) +		q5x_pc(0.600) Q1k(1.000)
98	SLR-2	Active G1(1.000) + T(-0.600) +	Add	G2(1.000) + P(1.000) +		q5x_pc(0.600) Q1k(1.000)
99	SLR-3	Active G1(1.000) + T(0.600) +	Add	G2(1.000) + P(1.000) +		q5x_pc(-0.600) Q1k(1.000)
100	SLR-4	Active G1(1.000) + T(-0.600) +	Add	G2(1.000) + P(1.000) +		q5x_pc(-0.600) Q1k(1.000)
101	SLR-5	Active G1(1.000) + T(0.600) +	Add	G2(1.000) + P(1.000) +		q5y_pc(0.600) Q1k(1.000)
102	SLR-6	Active G1(1.000) + T(-0.600) +	Add	G2(1.000) + P(1.000) +		q5y_pc(0.600) Q1k(1.000)
103	SLR-7	Active G1(1.000) + T(0.600) +	Add	G2(1.000) + P(1.000) +		q5y_pc(-0.600) Q1k(1.000)
104	SLR-8	Active G1(1.000) + T(-0.600) +	Add	G2(1.000) + P(1.000) +		q5y_pc(-0.600) Q1k(1.000)
105	SLR-9	Active G1(1.000) + q5x_pc(0.600) +	Add	G2(1.000) + T(0.600) +		Q2a(1.000) P(1.000)
106	SLR-10	Active G1(1.000) + q5x_pc(0.600) +	Add	G2(1.000) + T(-0.600) +		Q2a(1.000) P(1.000)
107	SLR-11	Active G1(1.000) + q5x_pc(-0.600) +	Add	G2(1.000) + T(0.600) +		Q2a(1.000) P(1.000)
108	SLR-12	Active G1(1.000) + q5x_pc(-0.600) +	Add	G2(1.000) + T(-0.600) +		Q2a(1.000) P(1.000)
109	SLR-13	Active G1(1.000) + q5y_pc(0.600) +	Add	G2(1.000) + T(0.600) +		Q2a(1.000) P(1.000)
110	SLR-14	Active G1(1.000) + q5y_pc(0.600) +	Add	G2(1.000) + T(-0.600) +		Q2a(1.000) P(1.000)
111	SLR-15	Active G1(1.000) + q5y_pc(-0.600) +	Add	G2(1.000) + T(0.600) +		Q2a(1.000) P(1.000)
112	SLR-16	Active G1(1.000) + q5y_pc(-0.600) +	Add	G2(1.000) + T(-0.600) +		Q2a(1.000) P(1.000)
113	SLR-17	Active	Add			

Sovrapasso di ingresso - Ponte strallato - Relazione di calcolo

		G1(1.000) + q5x_pc(0.600) +		G2(1.000) + T(0.600) +	Q2b(1.000) P(1.000)
114	SLR-18	Active	Add		
		G1(1.000) + q5x_pc(0.600) +		G2(1.000) + T(-0.600) +	Q2b(1.000) P(1.000)
115	SLR-19	Active	Add		
		G1(1.000) + q5x_pc(-0.600) +		G2(1.000) + T(0.600) +	Q2b(1.000) P(1.000)
116	SLR-20	Active	Add		
		G1(1.000) + q5x_pc(-0.600) +		G2(1.000) + T(-0.600) +	Q2b(1.000) P(1.000)
117	SLR-21	Active	Add		
		G1(1.000) + q5y_pc(0.600) +		G2(1.000) + T(0.600) +	Q2b(1.000) P(1.000)
118	SLR-22	Active	Add		
		G1(1.000) + q5y_pc(0.600) +		G2(1.000) + T(-0.600) +	Q2b(1.000) P(1.000)
119	SLR-23	Active	Add		
		G1(1.000) + q5y_pc(-0.600) +		G2(1.000) + T(0.600) +	Q2b(1.000) P(1.000)
120	SLR-24	Active	Add		
		G1(1.000) + q5y_pc(-0.600) +		G2(1.000) + T(-0.600) +	Q2b(1.000) P(1.000)
121	SLR-25	Active	Add		
		G1(1.000) + T(0.600) +		G2(1.000) + P(1.000) +	q5x_ps(1.000) Q2F(1.000)
122	SLR-26	Active	Add		
		G1(1.000) + T(-0.600) +		G2(1.000) + P(1.000) +	q5x_ps(1.000) Q2F(1.000)
123	SLR-27	Active	Add		
		G1(1.000) + T(0.600) +		G2(1.000) + P(1.000) +	q5x_ps(-1.000) Q2F(1.000)
124	SLR-28	Active	Add		
		G1(1.000) + T(-0.600) +		G2(1.000) + P(1.000) +	q5x_ps(-1.000) Q2F(1.000)
125	SLR-29	Active	Add		
		G1(1.000) + T(0.600) +		G2(1.000) + P(1.000) +	q5y_ps(1.000) Q2F(1.000)
126	SLR-30	Active	Add		
		G1(1.000) + T(-0.600) +		G2(1.000) + P(1.000) +	q5y_ps(1.000) Q2F(1.000)
127	SLR-31	Active	Add		
		G1(1.000) + T(0.600) +		G2(1.000) + P(1.000) +	q5y_ps(-1.000) Q2F(1.000)
128	SLR-32	Active	Add		
		G1(1.000) + T(-0.600) +		G2(1.000) + P(1.000) +	q5y_ps(-1.000) Q2F(1.000)
129	SLR-33	Active	Add		
		G1(1.000) + T(1.000) +		G2(1.000) + P(1.000) +	q5x_pc(0.600) Q2F(1.000)
130	SLR-34	Active	Add		
		G1(1.000) + T(1.000) +		G2(1.000) + P(1.000) +	q5x_pc(-0.600) Q2F(1.000)
131	SLR-35	Active	Add		
		G1(1.000) + T(-1.000) +		G2(1.000) + P(1.000) +	q5x_pc(-0.600) Q2F(1.000)
132	SLR-36	Active	Add		
		G1(1.000) + T(-1.000) +		G2(1.000) + P(1.000) +	q5x_pc(0.600) Q2F(1.000)
133	SLR-37	Active	Add		
		G1(1.000) + T(1.000) +		G2(1.000) + P(1.000) +	q5y_pc(0.600) Q2F(1.000)
134	SLR-38	Active	Add		
		G1(1.000) + T(1.000) +		G2(1.000) + P(1.000) +	q5y_pc(-0.600) Q2F(1.000)
135	SLR-39	Active	Add		
		G1(1.000) + T(-1.000) +		G2(1.000) + P(1.000) +	q5y_pc(-0.600) Q2F(1.000)
136	SLR-40	Active	Add		
		G1(1.000) + T(-1.000) +		G2(1.000) + P(1.000) +	q5y_pc(0.600) Q2F(1.000)
137	SLR-41	Active	Add		
		G1(1.000) + DT(1.000) +		G2(1.000) + P(1.000) +	q5x_pc(0.600) Q2F(1.000)
138	SLR-42	Active	Add		

Sovrapasso di ingresso - Ponte strallato - Relazione di calcolo

		G1(1.000) + DT(1.000) +		G2(1.000) + P(1.000) +	q5x_pc(-0.600) Q2F(1.000)
139	SLR-43	Active	Add		
		G1(1.000) + DT(-1.000) +		G2(1.000) + P(1.000) +	q5x_pc(-0.600) Q2F(1.000)
140	SLR-44	Active	Add		
		G1(1.000) + DT(-1.000) +		G2(1.000) + P(1.000) +	q5x_pc(0.600) Q2F(1.000)
141	SLR-45	Active	Add		
		G1(1.000) + DT(1.000) +		G2(1.000) + P(1.000) +	q5y_pc(0.600) Q2F(1.000)
142	SLR-46	Active	Add		
		G1(1.000) + DT(1.000) +		G2(1.000) + P(1.000) +	q5y_pc(-0.600) Q2F(1.000)
143	SLR-47	Active	Add		
		G1(1.000) + DT(-1.000) +		G2(1.000) + P(1.000) +	q5y_pc(-0.600) Q2F(1.000)
144	SLR-48	Active	Add		
		G1(1.000) + DT(-1.000) +		G2(1.000) + P(1.000) +	q5y_pc(0.600) Q2F(1.000)
145	SLQP-1	Active	Add		
		G1(1.000) + P(1.000)		G2(1.000) +	T(0.500)
146	SLQP-2	Active	Add		
		G1(1.000) + P(1.000)		G2(1.000) +	T(-0.500)
147	SLF-1	Active	Add		
		G1(1.000) + P(1.000) +		G2(1.000) + Q2F(1.000)	T(0.500)
148	SLF-2	Active	Add		
		G1(1.000) + P(1.000) +		G2(1.000) + Q2F(1.000)	T(-0.500)
149	SLF-3	Active	Add		
		G1(1.000) + T(0.500) +		G2(1.000) + P(1.000)	q5x_pc(0.200)
150	SLF-4	Active	Add		
		G1(1.000) + T(-0.500) +		G2(1.000) + P(1.000)	q5x_pc(0.200)
151	SLF-5	Active	Add		
		G1(1.000) + T(0.500) +		G2(1.000) + P(1.000)	q5x_pc(-0.200)
152	SLF-6	Active	Add		
		G1(1.000) + T(-0.500) +		G2(1.000) + P(1.000)	q5x_pc(-0.200)
153	SLF-7	Active	Add		
		G1(1.000) + T(0.500) +		G2(1.000) + P(1.000)	q5y_pc(0.200)
154	SLF-8	Active	Add		
		G1(1.000) + T(-0.500) +		G2(1.000) + P(1.000)	q5y_pc(0.200)
155	SLF-9	Active	Add		
		G1(1.000) + T(0.500) +		G2(1.000) + P(1.000)	q5y_pc(-0.200)
156	SLF-10	Active	Add		
		G1(1.000) + T(-0.500) +		G2(1.000) + P(1.000)	q5y_pc(-0.200)
157	INVSLU	Active	Envelope		
		SLU-1(1.000) + SLU-4(1.000) + SLU-7(1.000) + SLU-10(1.000) + SLU-13(1.000) + SLU-16(1.000) + SLU-19(1.000) + SLU-22(1.000) + SLU-25(1.000) + SLU-28(1.000) + SLU-31(1.000) + SLU-34(1.000) + SLU-37(1.000) + SLU-40(1.000) + SLU-43(1.000) + SLU-46(1.000) + SLU-49(1.000) + SLU-52(1.000) + SLU-55(1.000) + SLU-58(1.000) + SLU-61(1.000) +		SLU-2(1.000) + SLU-5(1.000) + SLU-8(1.000) + SLU-11(1.000) + SLU-14(1.000) + SLU-17(1.000) + SLU-20(1.000) + SLU-23(1.000) + SLU-26(1.000) + SLU-29(1.000) + SLU-32(1.000) + SLU-35(1.000) + SLU-38(1.000) + SLU-41(1.000) + SLU-44(1.000) + SLU-47(1.000) + SLU-50(1.000) + SLU-53(1.000) + SLU-56(1.000) + SLU-59(1.000) + SLU-62(1.000) +	SLU-3(1.000) SLU-6(1.000) SLU-9(1.000) SLU-12(1.000) SLU-15(1.000) SLU-18(1.000) SLU-21(1.000) SLU-24(1.000) SLU-27(1.000) SLU-30(1.000) SLU-33(1.000) SLU-36(1.000) SLU-39(1.000) SLU-42(1.000) SLU-45(1.000) SLU-48(1.000) SLU-51(1.000) SLU-54(1.000) SLU-57(1.000) SLU-60(1.000) SLU-63(1.000)
158	INVSLU-appoggi	Active	Envelope		
		SLU-49(1.000) +		SLU-50(1.000) +	SLU-51(1.000)

+		SLU-52(1.000) +		SLU-53(1.000) +		SLU-54(1.000)
+		SLU-55(1.000) +		SLU-56(1.000) +		SLU-57(1.000)
+		SLU-58(1.000) +		SLU-59(1.000) +		SLU-60(1.000)
+		SLU-61(1.000) +		SLU-62(1.000) +		SLU-63(1.000)

159	INVS LV	Active		Envelope		
		SLV1x(1.000) +		SLV2x(1.000) +		SLV3x(1.000)
+		SLV4x(1.000) +		SLV5x(1.000) +		SLV6x(1.000)
+		SLV7y(1.000) +		SLV8x(1.000) +		SLV1y(1.000)
+		SLV2y(1.000) +		SLV3y(1.000) +		SLV4y(1.000)
+		SLV5y(1.000) +		SLV6y(1.000) +		SLV7x(1.000)
+		SLV8y(1.000) +		SLV1z(1.000) +		SLV2z(1.000)
+		SLV3z(1.000) +		SLV4z(1.000) +		SLV5z(1.000)
+		SLV6z(1.000) +		SLV7z(1.000) +		SLV8z(1.000)

160	INVS LER	Active		Envelope		
		SLR-1(1.000) +		SLR-2(1.000) +		SLR-3(1.000)
+		SLR-4(1.000) +		SLR-5(1.000) +		SLR-6(1.000)
+		SLR-7(1.000) +		SLR-8(1.000) +		SLR-9(1.000)
+		SLR-10(1.000) +		SLR-11(1.000) +		SLR-12(1.000)
+		SLR-13(1.000) +		SLR-14(1.000) +		SLR-15(1.000)
+		SLR-16(1.000) +		SLR-17(1.000) +		SLR-18(1.000)
+		SLR-19(1.000) +		SLR-20(1.000) +		SLR-21(1.000)
+		SLR-22(1.000) +		SLR-23(1.000) +		SLR-24(1.000)
+		SLR-25(1.000) +		SLR-26(1.000) +		SLR-27(1.000)
+		SLR-28(1.000) +		SLR-29(1.000) +		SLR-30(1.000)
+		SLR-31(1.000) +		SLR-32(1.000) +		SLR-33(1.000)
+		SLR-34(1.000) +		SLR-35(1.000) +		SLR-36(1.000)
+		SLR-37(1.000) +		SLR-38(1.000) +		SLR-39(1.000)
+		SLR-40(1.000) +		SLR-41(1.000) +		SLR-42(1.000)
+		SLR-43(1.000) +		SLR-44(1.000) +		SLR-45(1.000)
+		SLR-46(1.000) +		SLR-47(1.000) +		SLR-48(1.000)

161	INVS LEQ	Active		Envelope		
		SLQP-1(1.000) +		SLQP-2(1.000)		

162	INVS LEF	Active		Envelope		
		SLF-1(1.000) +		SLF-2(1.000) +		SLF-3(1.000)
+		SLF-4(1.000) +		SLF-5(1.000) +		SLF-6(1.000)
+		SLF-7(1.000) +		SLF-8(1.000) +		SLF-9(1.000)
+		SLF-10(1.000)				

7.3 Studio delle fasi costruttive

Il software di calcolo adottato consente di eseguire analisi per fasi costruttive delle strutture. Pertanto, è possibile studiare gli stati deformativi e tensionali dei singoli elementi durante lo svolgimento della “vita” della struttura e durante le fasi costruttive della stessa. Pertanto, si sono implementate nel modello di calcolo le seguenti quattro fasi costruttive:

- **Fase 1:** Realizzazione delle strutture in c.a. ovvero fondazioni, pile ed antenna. Posa in opera dei conci preassemblati dell’impalcato su appoggi temporanei. In questa fase i tre conci sono indipendenti, non essendo completate le saldature, si sono utilizzati, pertanto, vincoli interni a cerniera. I carichi agenti in questa fase sono il peso proprio, il vento e la neve.
- **Fase 2:** Realizzazione delle giunzioni tra i conci mediante saldature realizzate in opera, si sono, pertanto, disattivati i vincoli interni a cerniera nella modellazione.
- **Fase 3:** Montaggio degli stralli di sospensione.
- **Fase 4:** Rimozione dei vincoli esterni temporanei, applicazione dei carichi permanenti e pretensione degli stralli.

Si è considerata una vita temporale di 30000 giorni al fine di ottenere il raggiungimento dei valori finali delle deformazioni da ritiro e viscosità del calcestruzzo dell’antenna. Si riporta di seguito la tabella di attivazione e disattivazione degli elementi strutturali, dei vincoli e dei carichi e le immagini del modello nelle fasi suddette.

Element

	Group Name	fase 1		fase 2		fase 3		fase 4	
		A	T	A	T	A	T	A	T
	struttura	O	O		O		O		O
	strallo1s					O	O		O
	strallo1d					O	O		O
	strallo2s					O	O		O
	strallo2d					O	O		O
	strallo3s					O	O		O
	strallo3d					O	O		O
	strallo4s					O	O		O
	strallo4d					O	O		O
	strallo5s					O	O		O
	strallo5d					O	O		O
	strallo6s					O	O		O
	strallo6d					O	O		O
	strallo7s					O	O		O
	strallo7d					O	O		O

Boundary

	Group Name	fase 1		fase 2		fase 3		fase 4	
		A	T	A	T	A	T	A	T
	vincoli	O	O		O		O		O
	puntelli	O	O		O		O	X	
	saldature	O	O	X					

Load

	Group Name	fase 1		fase 2		fase 3		fase 4	
		A	T	A	T	A	T	A	T
	peso proprio	O	O		O		O		O
	permanenti							O	O
	pretensione							O	O
	neve	O	O		O		O	X	
	vento ps	O	O		O		O	X	

Tabella 4. Attivazione e disattivazione degli elementi, dei vincoli e dei carichi nelle fasi



Figura 26 – Modello Fase 1



Figura 27 – Modello Fase 2

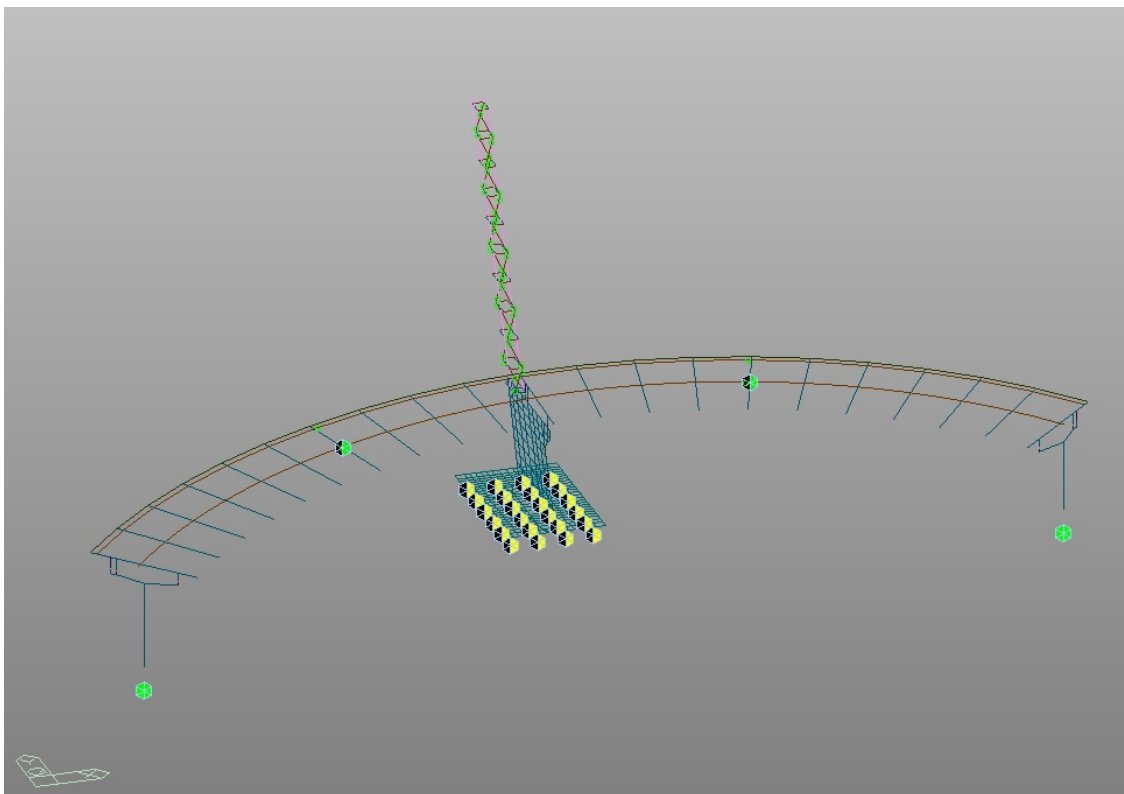

Figura 28 – Modello Fase 3

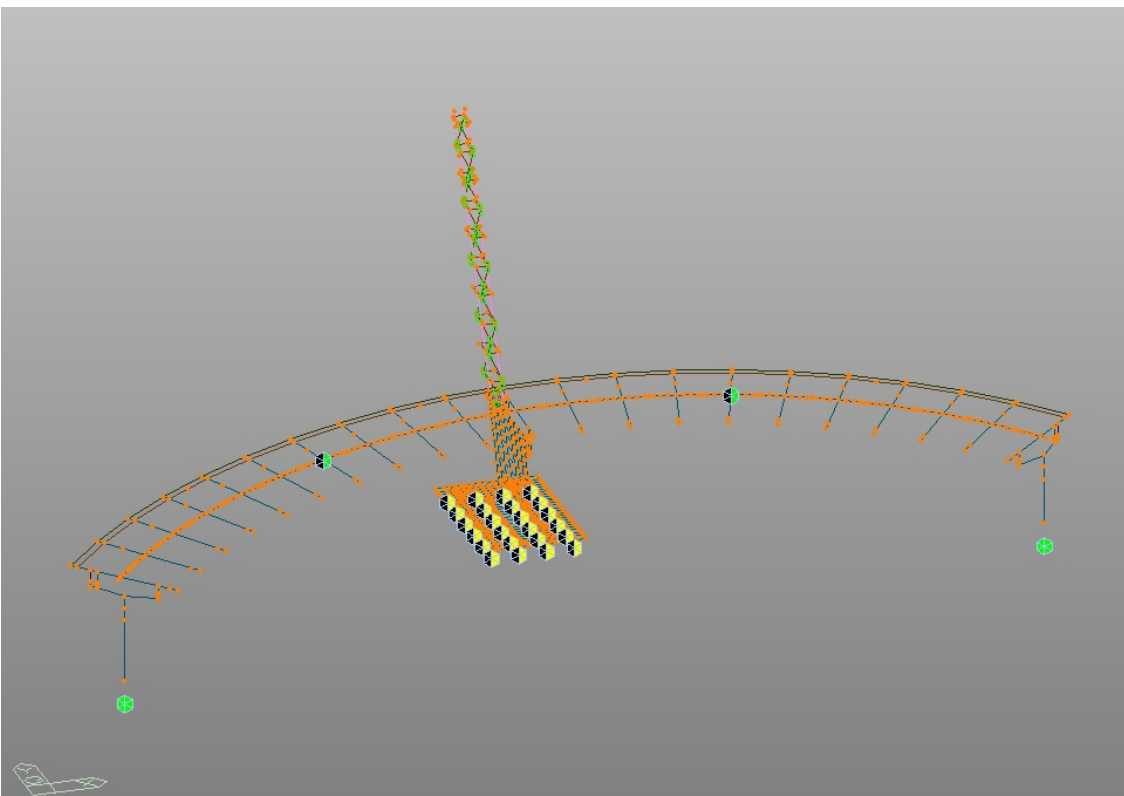

Figura 29 – Modello Fase 4

8. Verifiche delle strutture in acciaio di impalcato

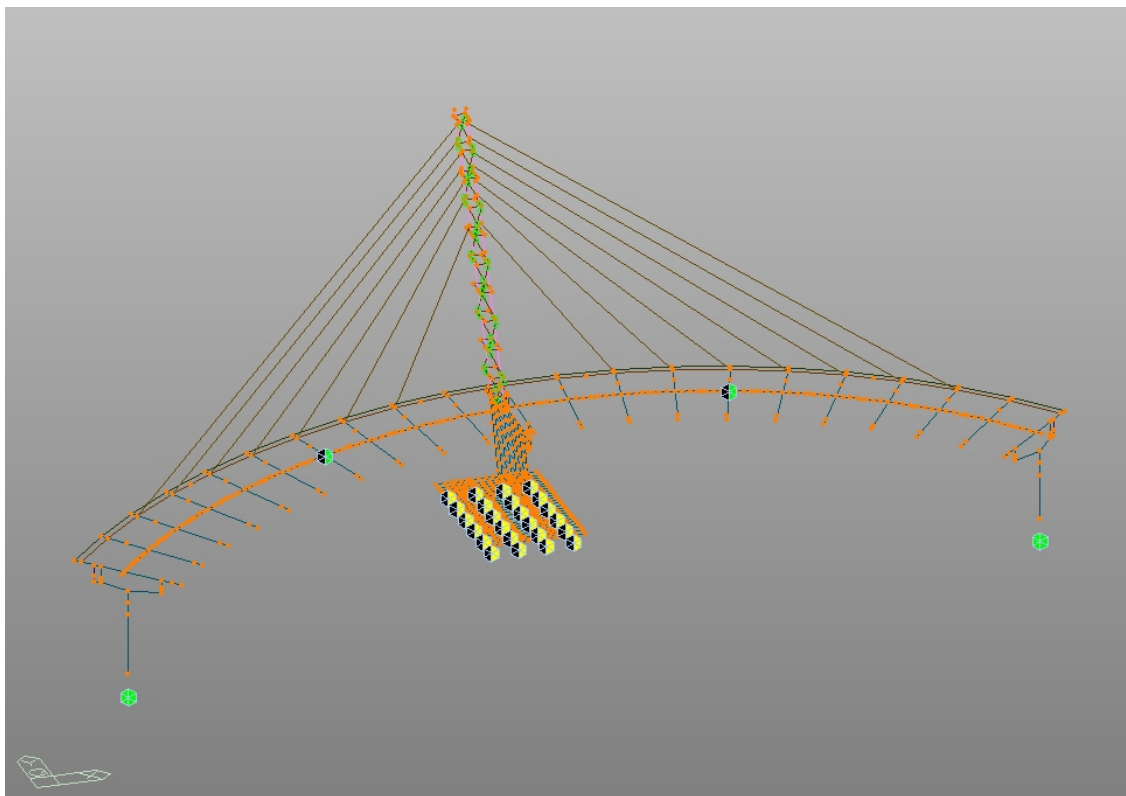
8.1 Premessa

Di seguito, vengono presentate le verifiche di resistenza delle strutture in acciaio di impalcato. Le verifiche sono state effettuate per tutte le membrature e per le combinazioni delle sollecitazioni di cui al par.7.2. Per brevità, si riportano le sole verifiche più gravose.

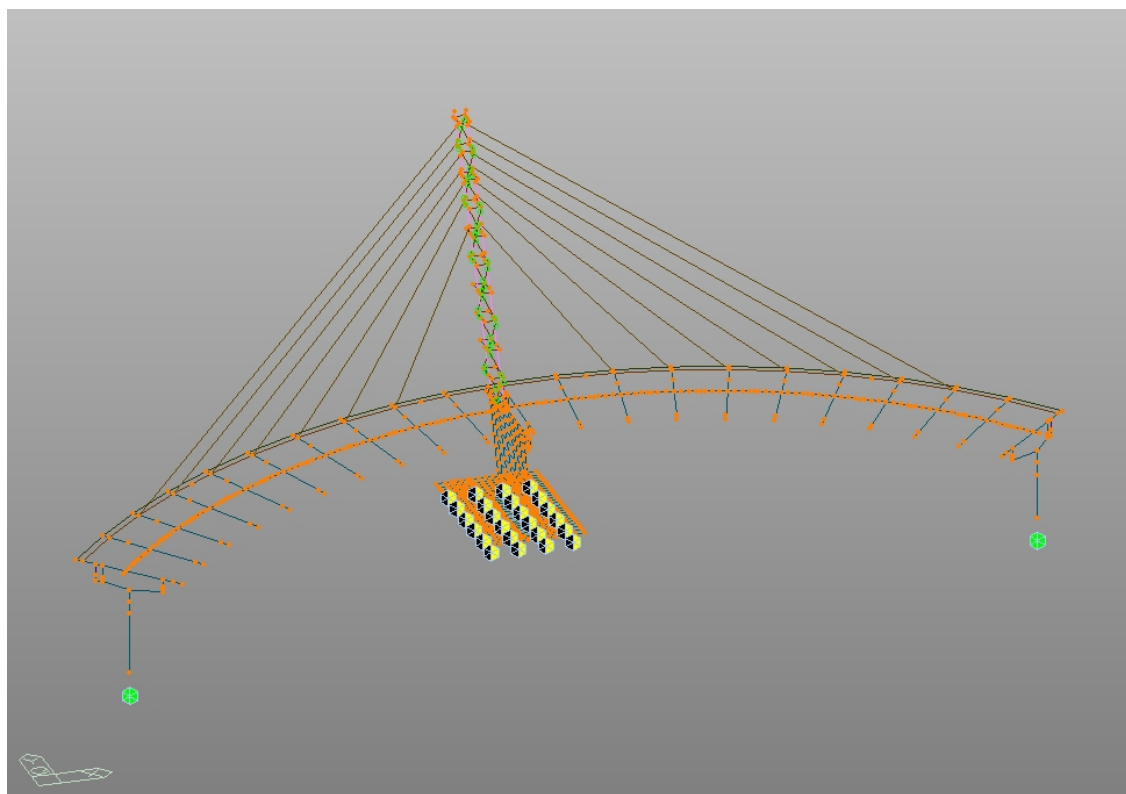
8.2 Verifiche di resistenza delle membrature

Le verifiche di resistenza delle membrature della trave a cassone in acciaio sono state svolte in accordo con quanto indicato al punto 4.2.4.1.2 – *N.T.C.*, adottando il “metodo elastico”, applicabile per qualsiasi classe di sezione, ovvero limitando lo stato tensionale e di deformazione al limite elastico del materiale utilizzato. Pertanto, in ogni punto della struttura occorre verificare che la tensione ideale (Von-Mises) non superi la resistenza di calcolo:

$$\sigma_{\text{eff.}} = \sqrt{(\sigma_{x,Ed}^2 + \sigma_{z,Ed}^2 - \sigma_{x,Ed} \sigma_{z,Ed} + 3\tau_{Ed}^2)} \leq f_{yd} = 338 \text{ MPa} \quad (1)$$

dove:

$\sigma_{x,Ed}$ è il valore di calcolo della tensione normale nel punto in esame, agente in direzione parallela all'asse della membratura;

$\sigma_{z,Ed}$ è il valore di calcolo della tensione normale nel punto in esame, agente in direzione ortogonale all'asse della membratura;

τ_{Ed} è il valore di calcolo della tensione tangenziale nel punto in esame, agente nel piano della sezione della membratura.

Trave a cassone

Di seguito, si riportano le immagini relative alle caratteristiche della sollecitazione agenti, relative agli involucri delle combinazioni SLU e per le fasi costruttive considerate.



Figura 30 – Sforzo normale (SLU)



Figura 31 – Momento flettente asse y (SLU)

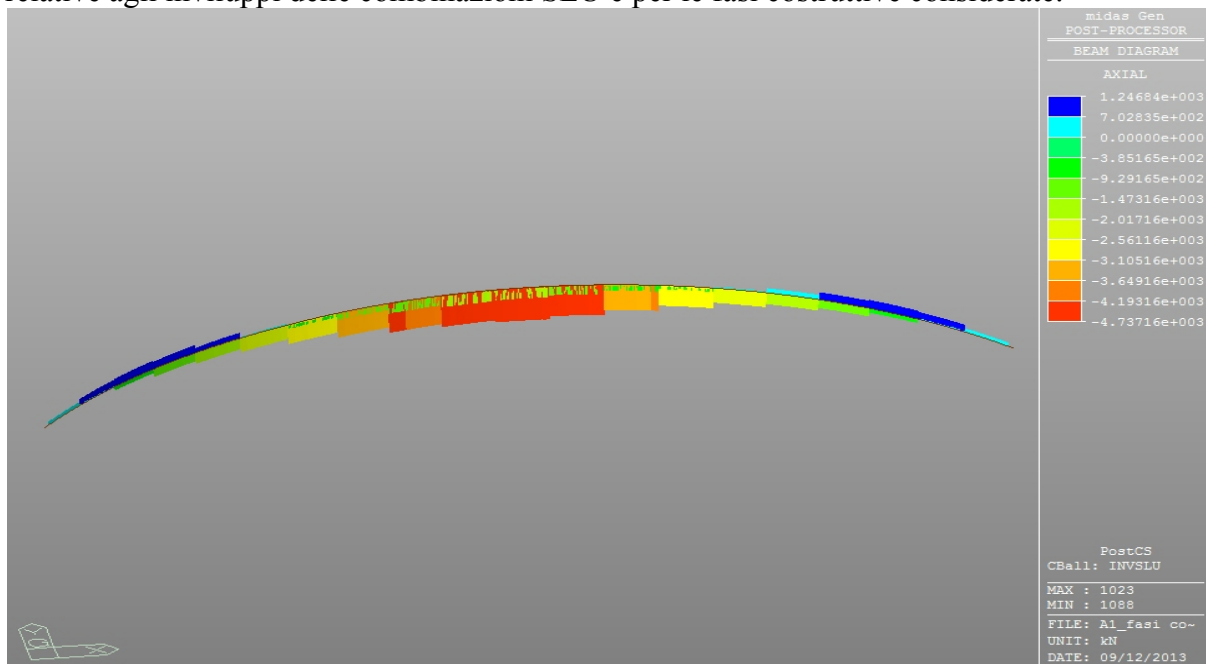

Figura 32 – Momento flettente asse z (SLU)

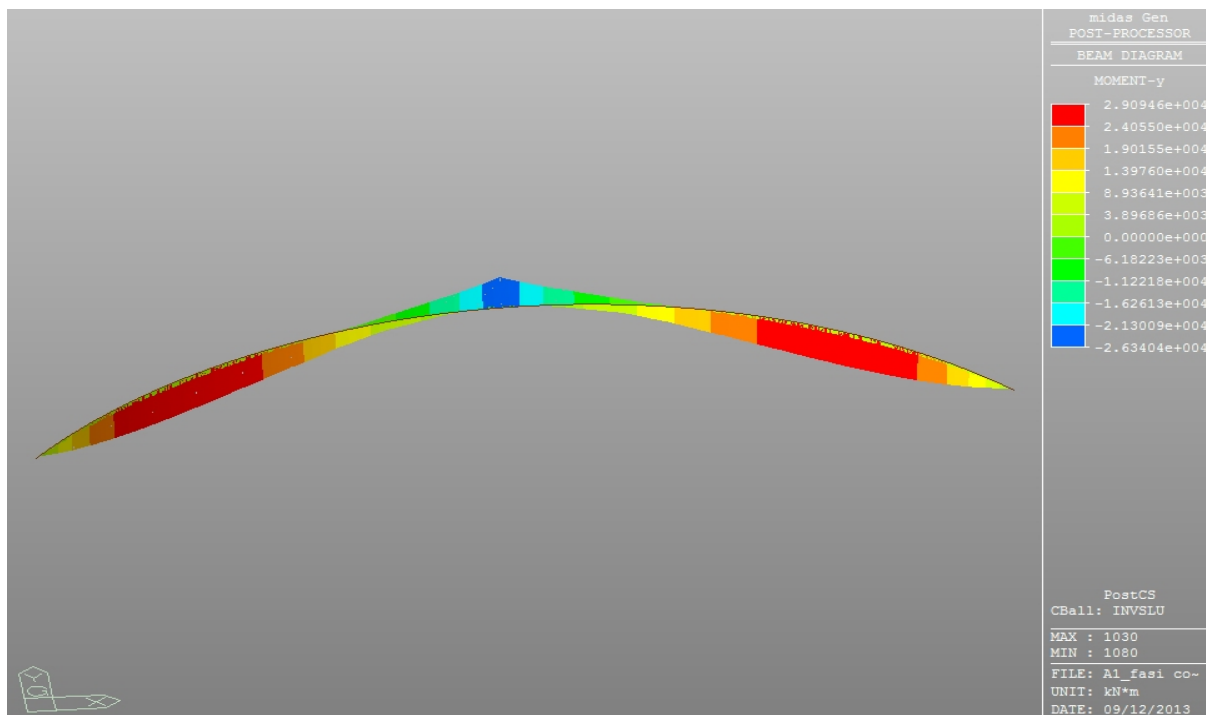

Figura 33 – Taglio asse z (SLU)

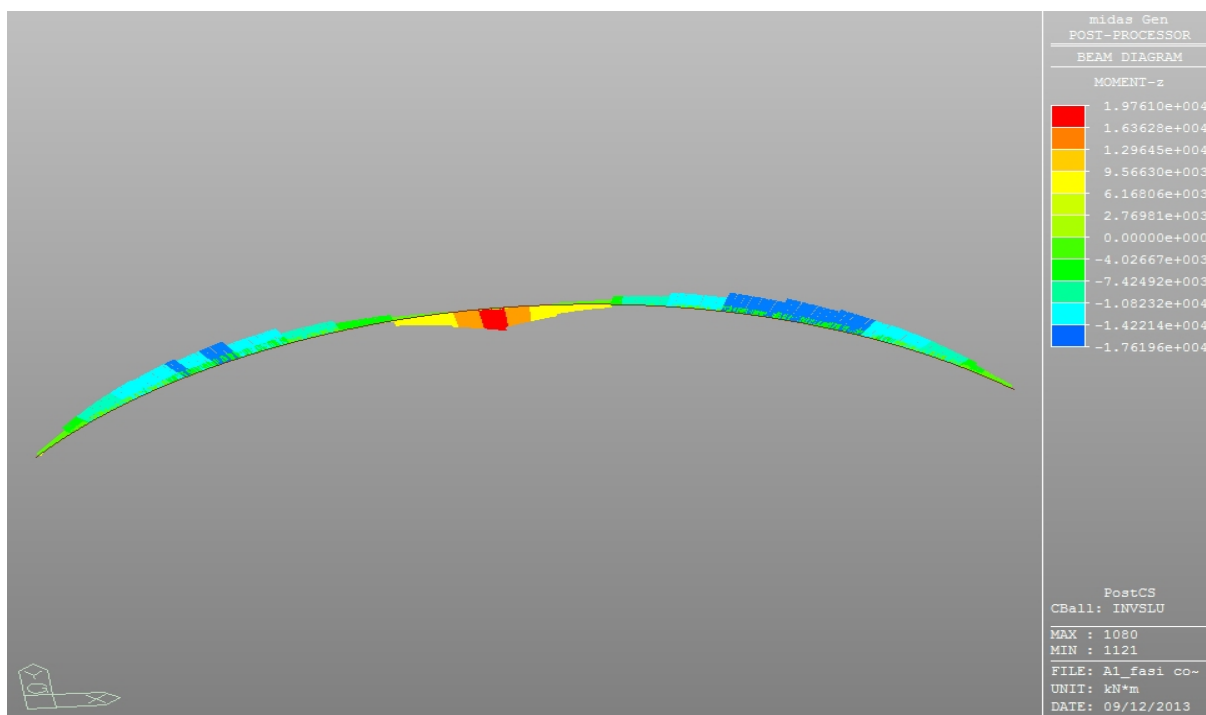

Figura 34 – Taglio asse y (SLU)

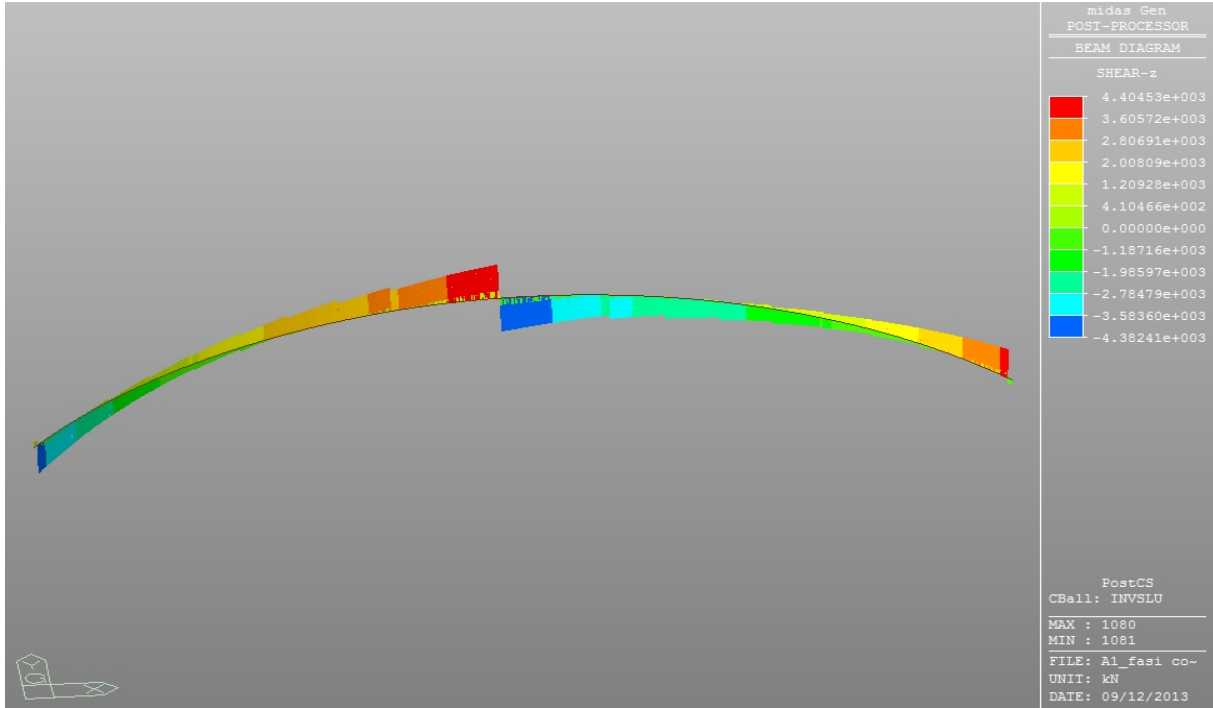

Figura 35 – Torsione (SLU)

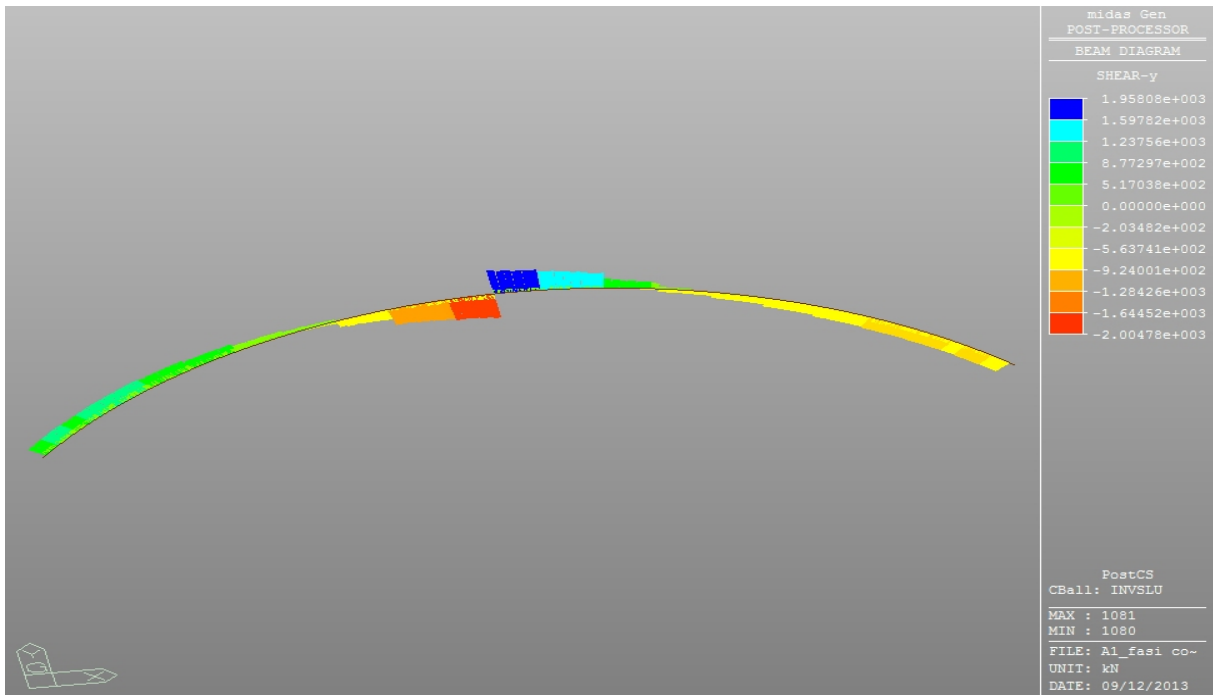

Figura 36 – Fase 1: momenti flettenti asse y da peso proprio

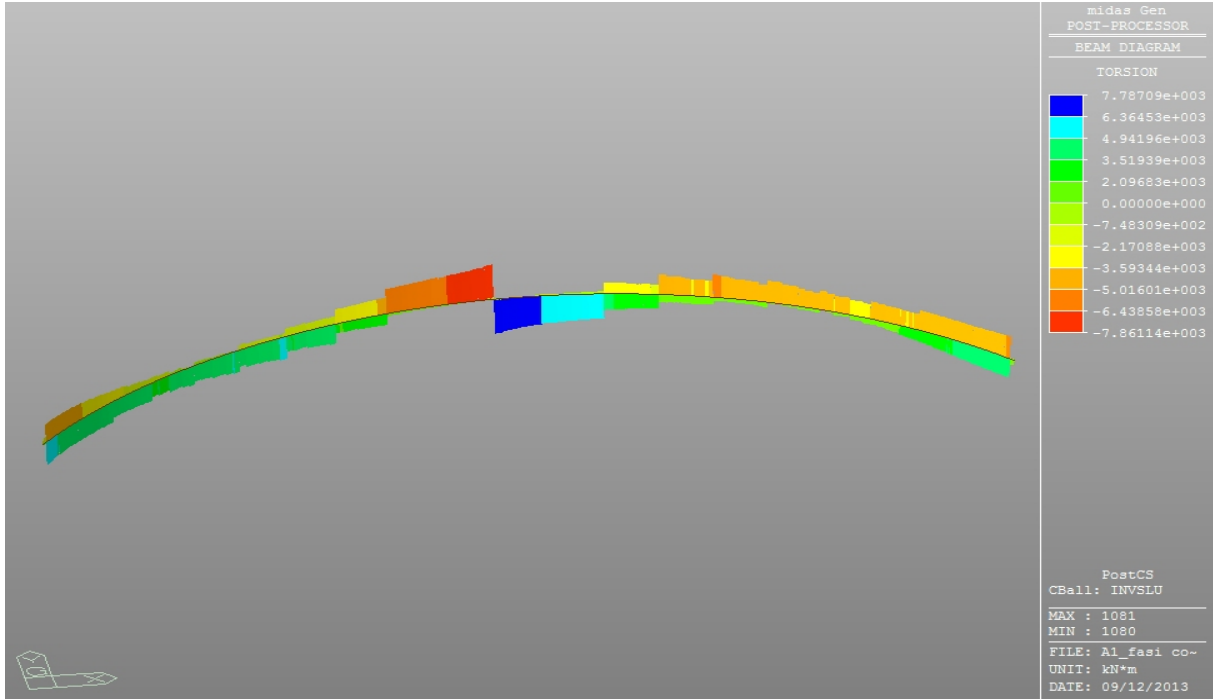

Figura 37 – Fase 4: momenti flettenti asse y in seguito alla rimozione dei puntelli provvisori

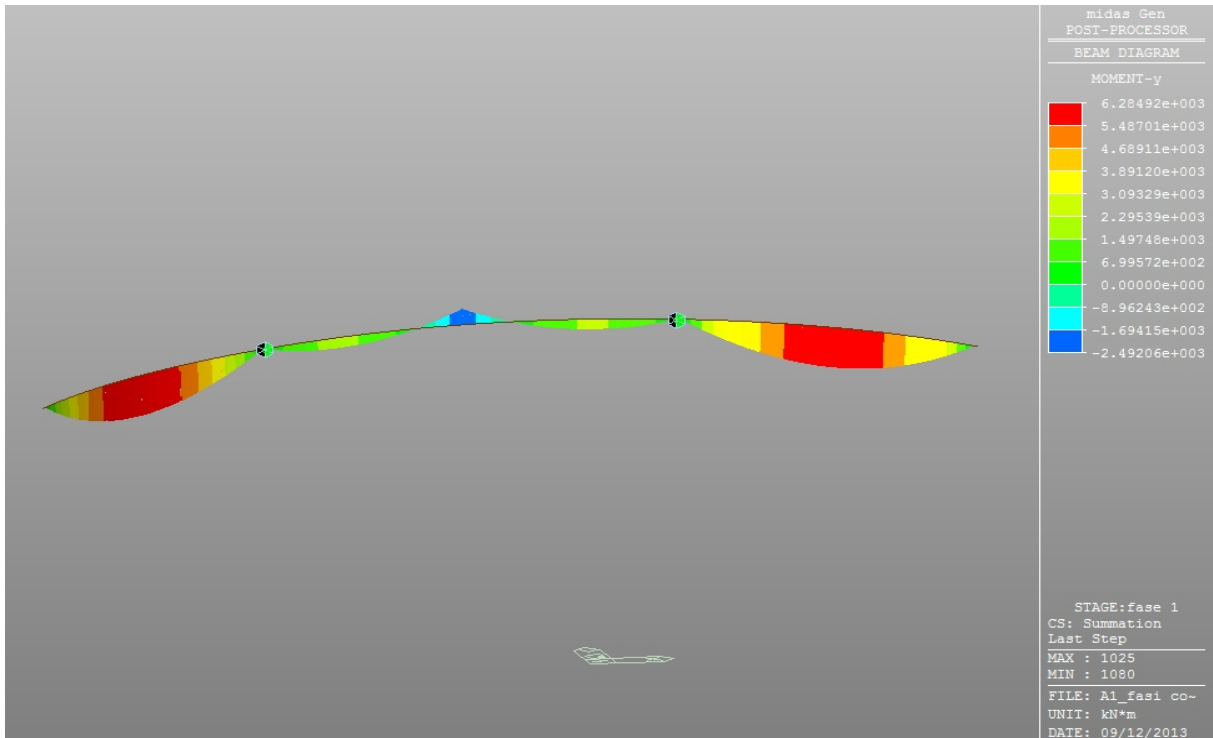

Figura 38 – Fase 4: momenti flettenti asse y in seguito alla applicazione dei sovraccarichi permanenti e della pretensione degli stralli

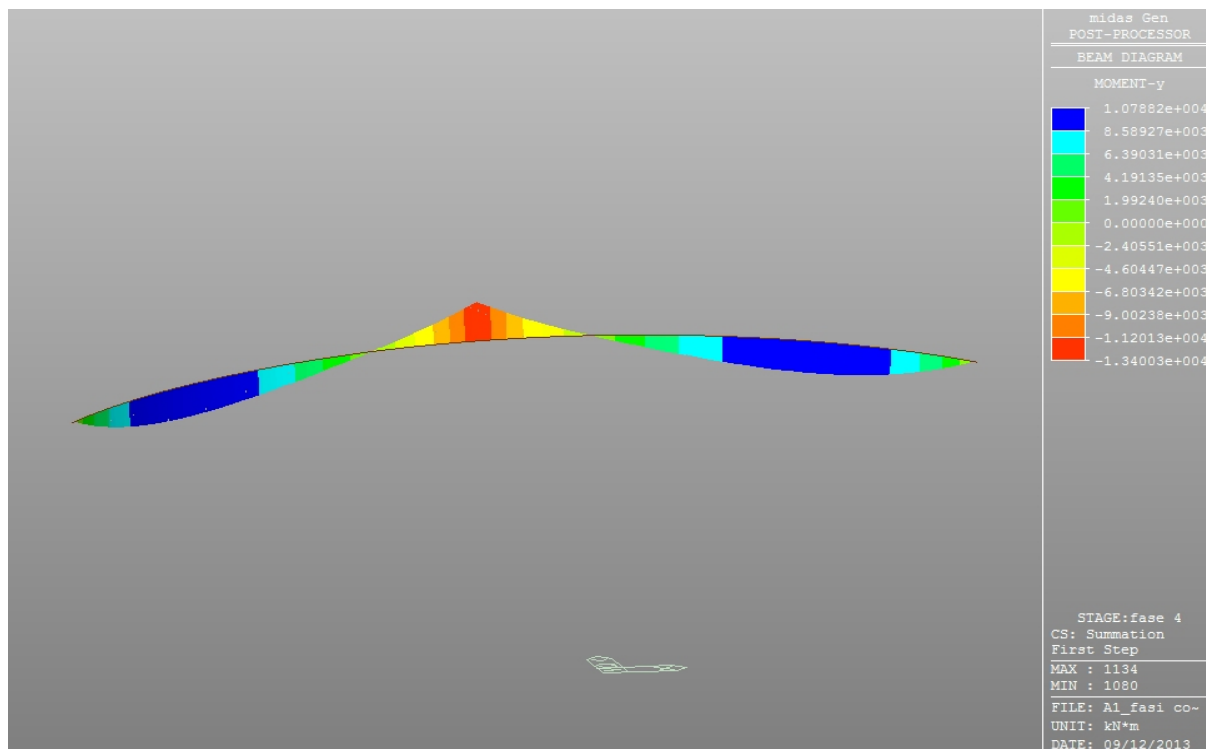

Figura 39 – Fase 4: momenti flettenti asse y a lungo termine per valori finali del ritiro e della viscosità del calcestruzzo dell'antenna

Di seguito, si riportano le immagini relative agli stati tensionali per le verifiche di resistenza, nonché per la sezione di massimo momento flettente positivo in campata e negativo in corrispondenza dell'appoggio centrale, le tensioni ideali alla Von-Mises delle sezioni della trave a cassone.

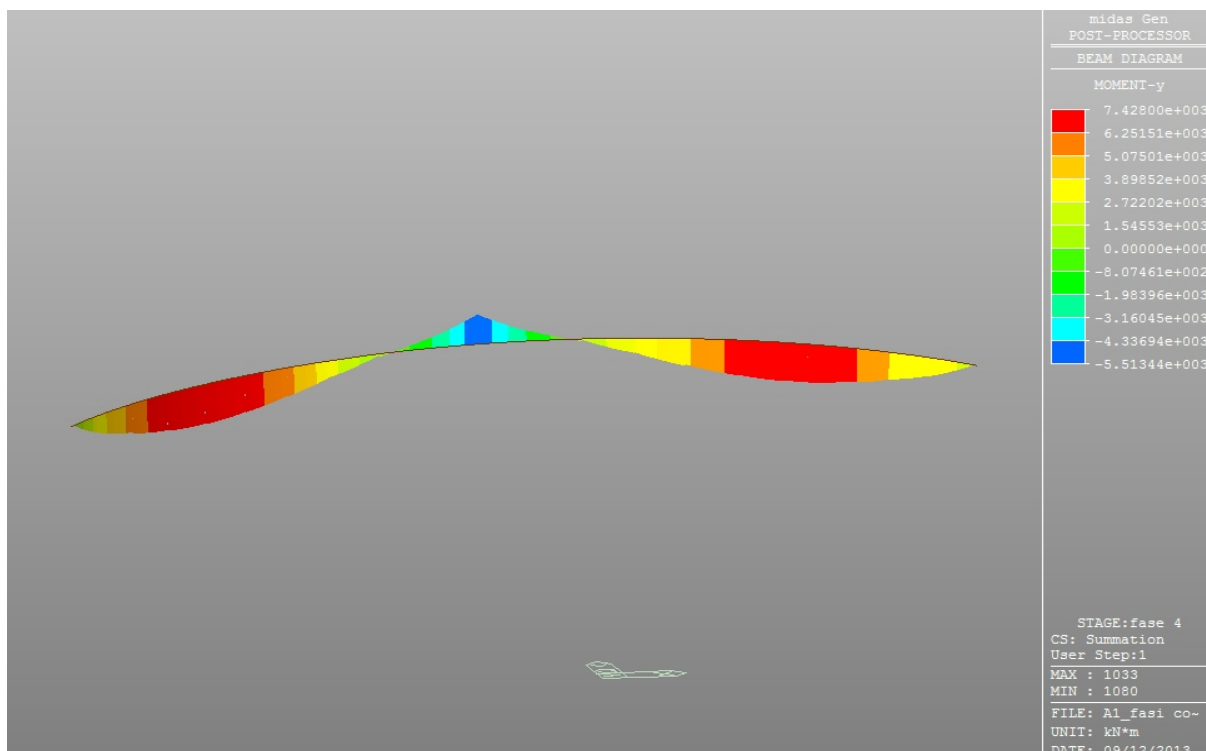

Figura 40 – Tensioni normali massime (SLU)

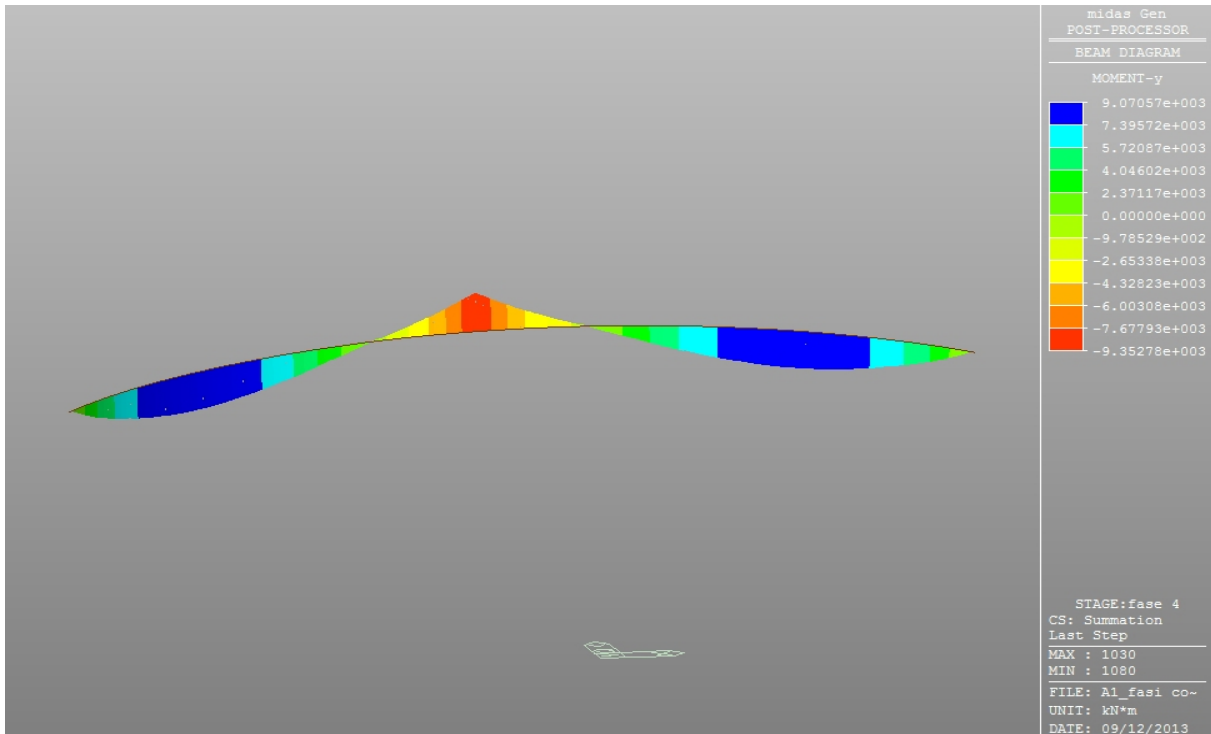

Figura 41 – Tensioni di taglio massime asse y (SLU)

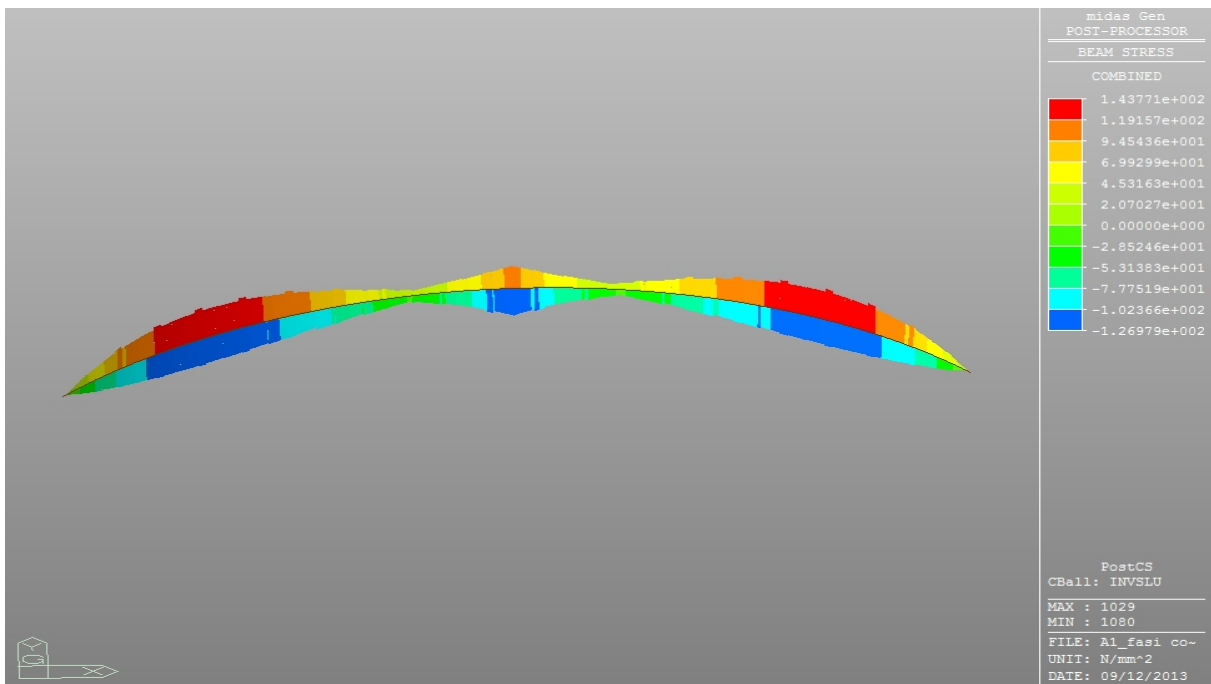

Figura 42 – Tensioni di taglio massime asse z (SLU)

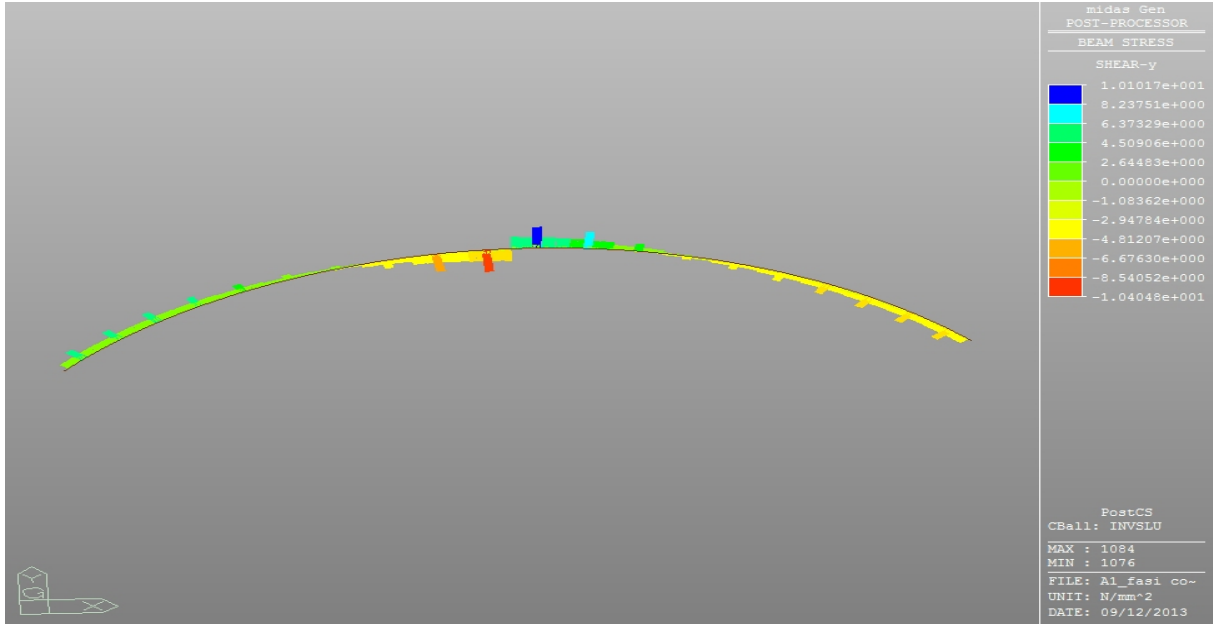

Figura 43 – Tensioni ideali (SLU) per la sezione in corrispondenza dell'appoggio centrale

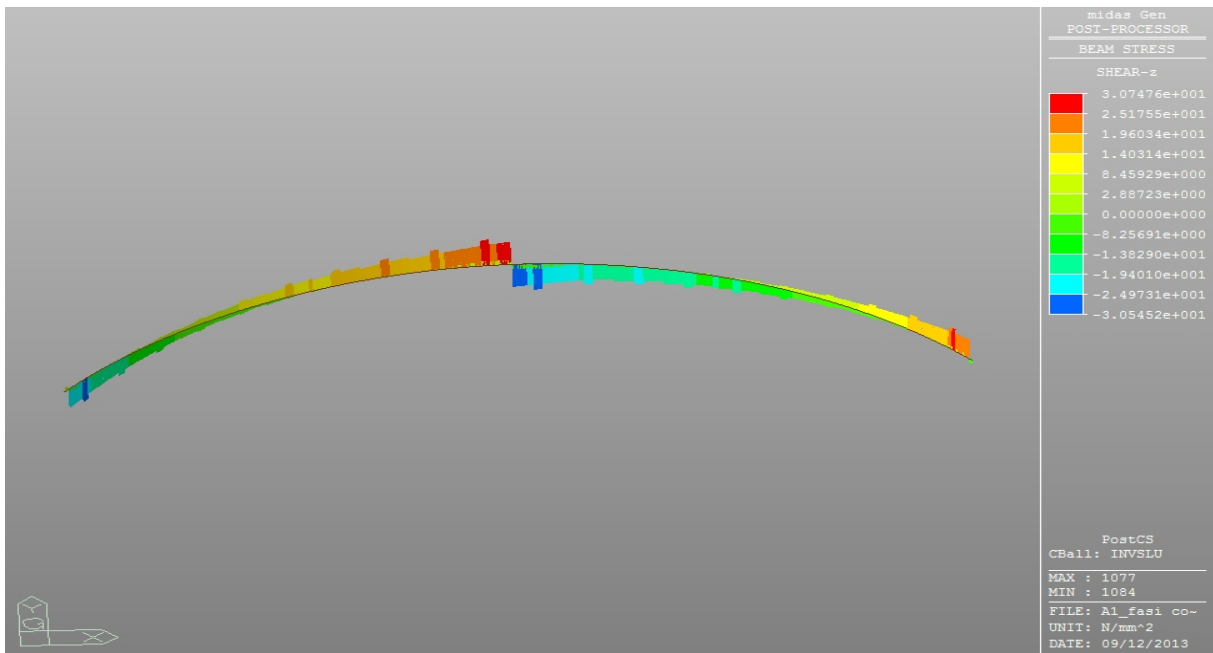

Figura 44 – Tensioni ideali (SLU) per la sezione in campata

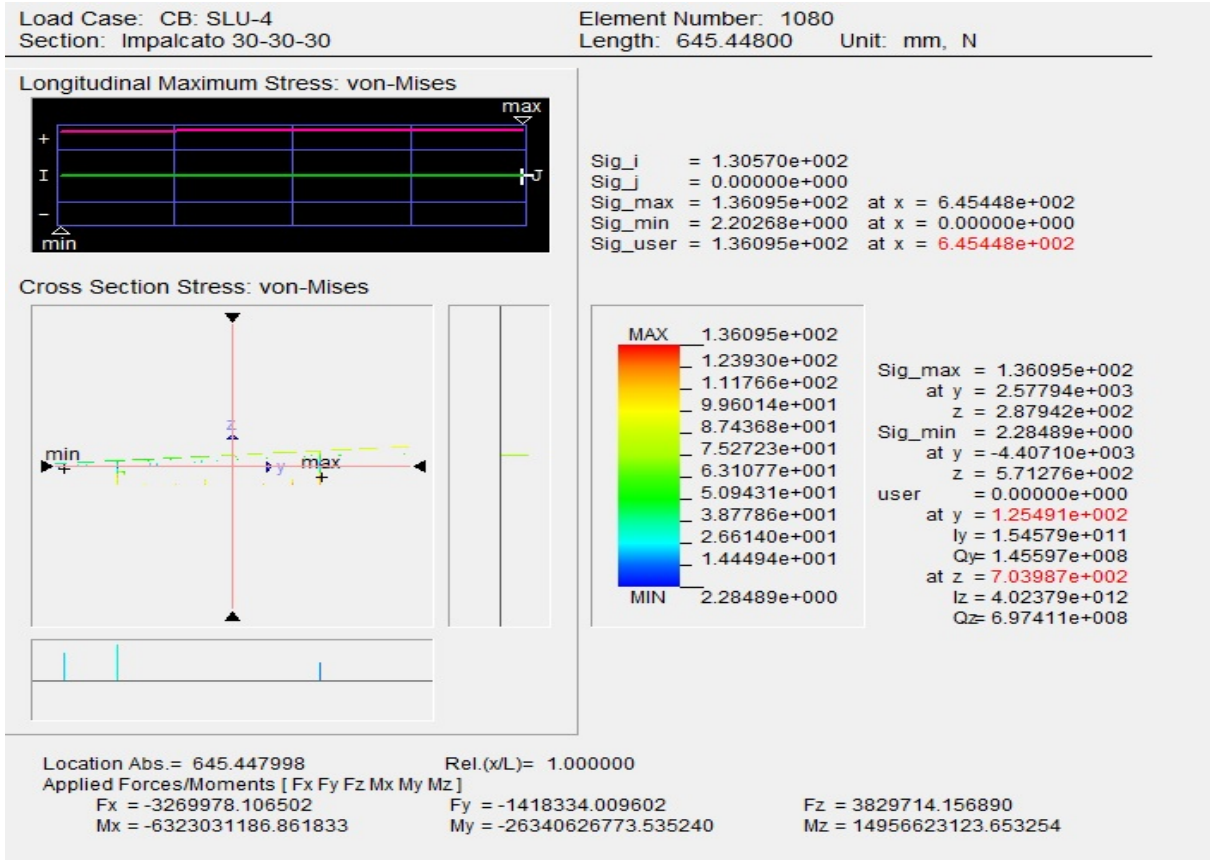

Figura 45 – Tensioni ideali (SLU) per la sezione in campata in corrispondenza dei fori di ispezione

Di seguito, si riportano le immagini relative agli stati tensionali relativi alla piastra superiore ortotropa del cassone per la verifica degli effetti locali (taglio e momento flettente).

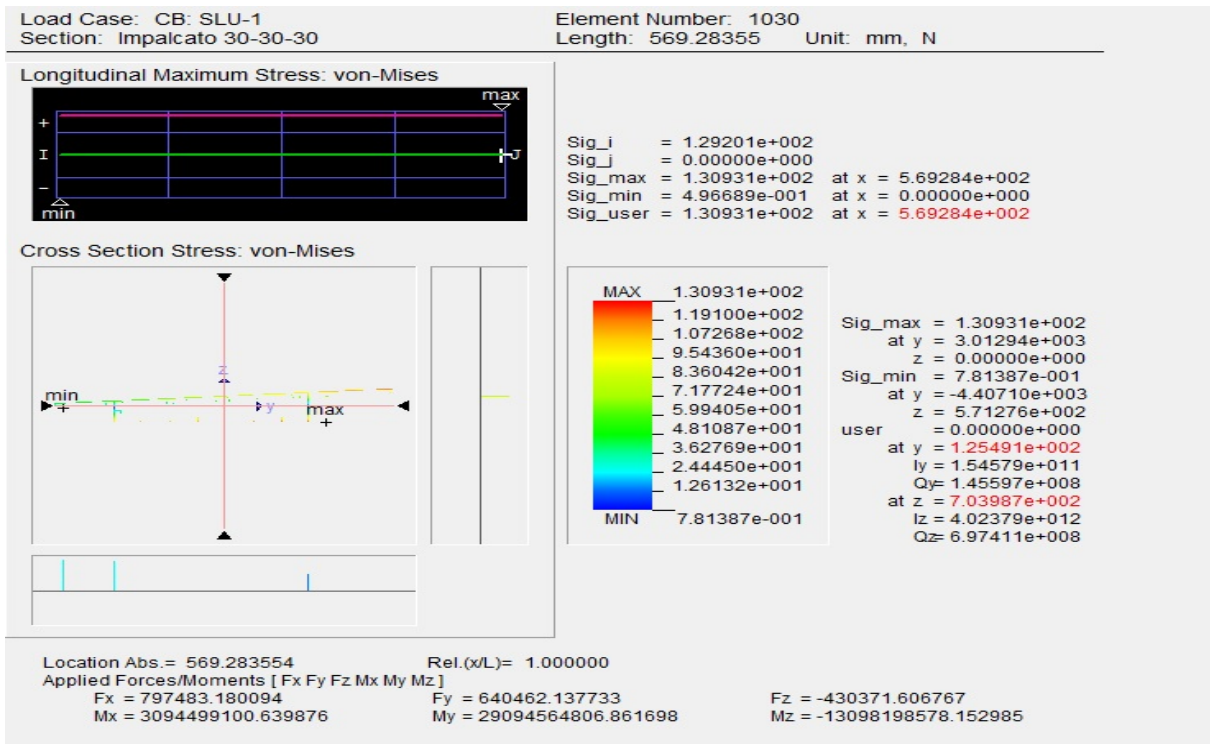

Figura 46 – Tensioni ideali (SLU) della piastra sp.30mm

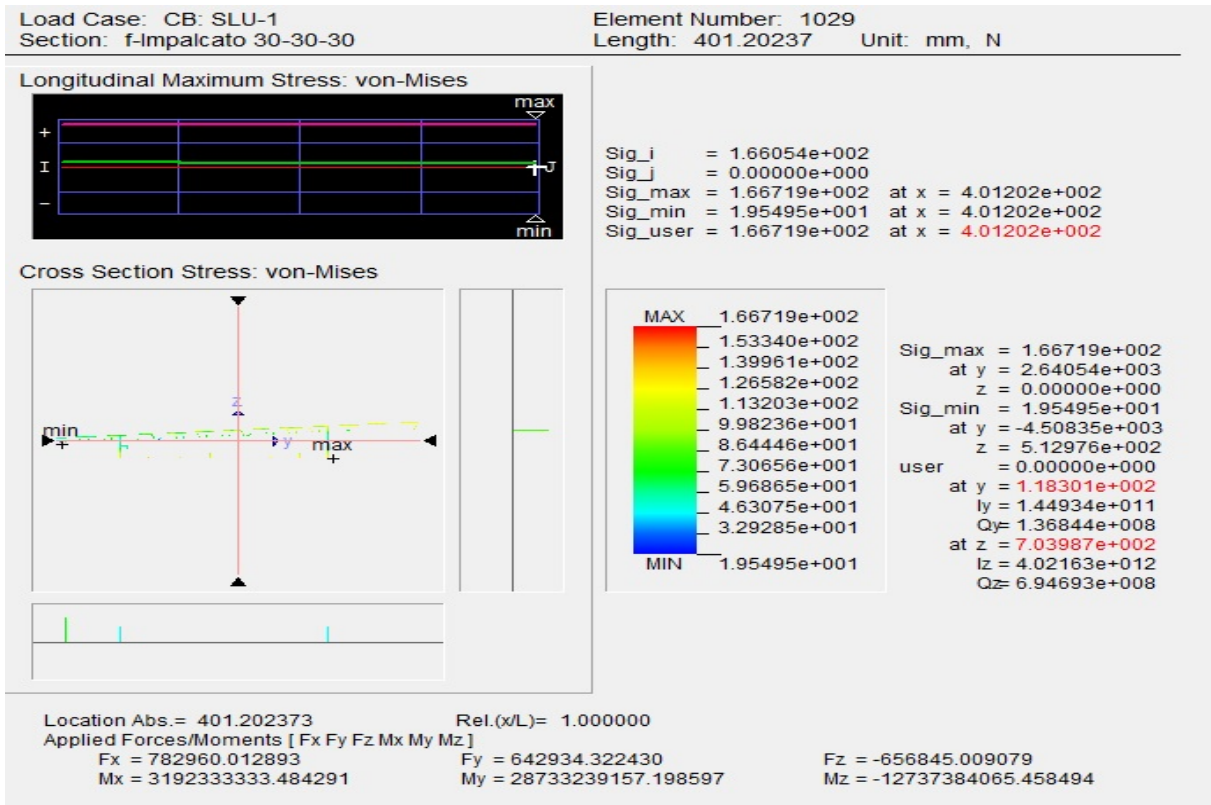

Figura 47 – Tensioni ideali (SLU) degli irrigidimenti della piastra sp.30mm

Traversi

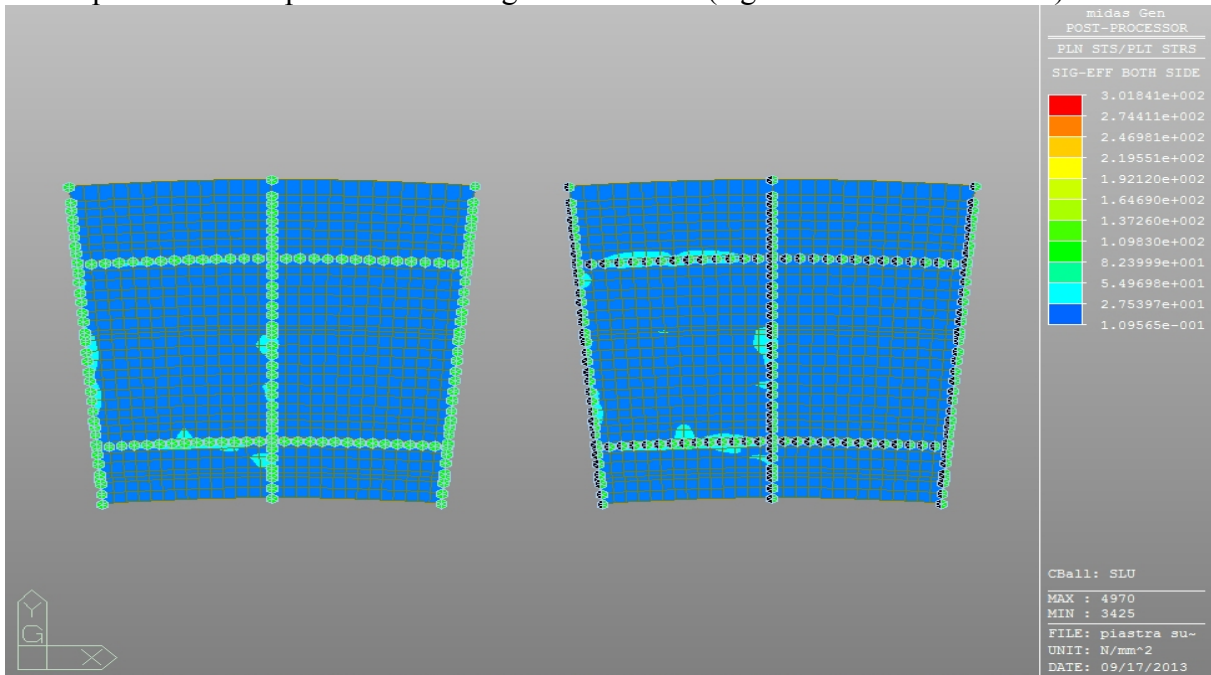
Di seguito, si riportano le immagini relative alle caratteristiche della sollecitazione agenti, relative agli involucri delle combinazioni SLU del tratto di traverso a sbalzo dall'anima del cassone (lato stralli).

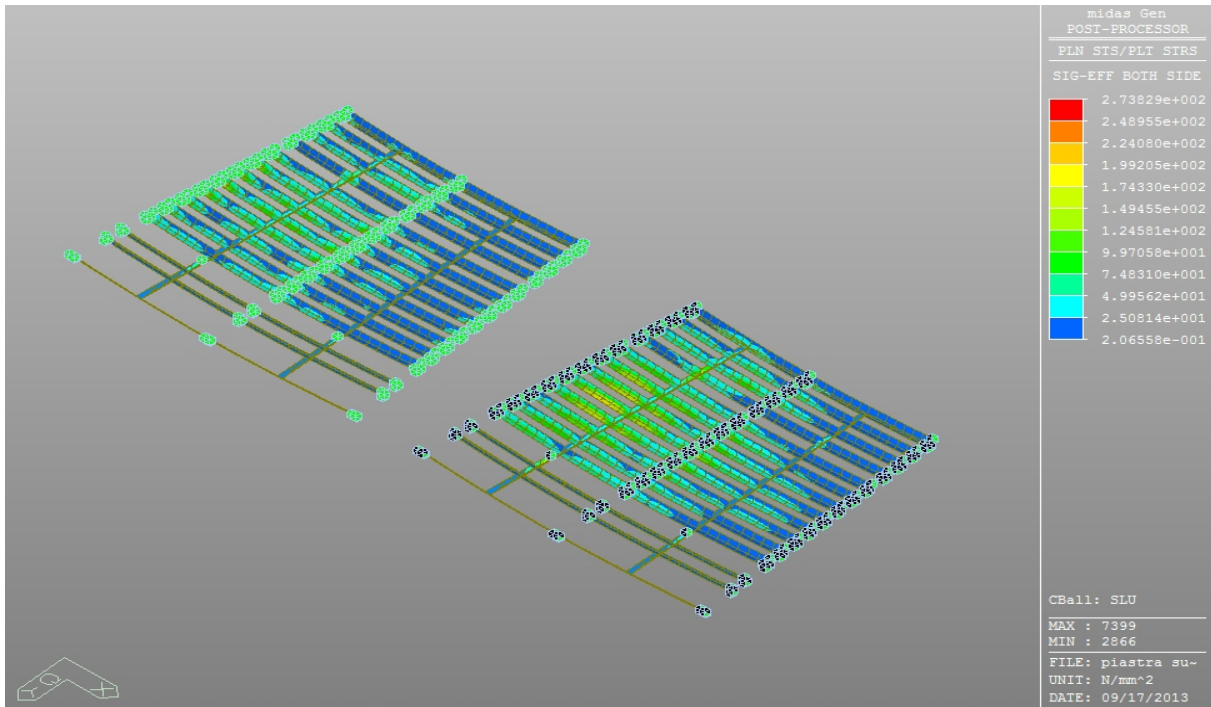

Figura 48 – Sforzo normale (SLU) del traverso intermedio (in basso) e del traverso dell'appoggio centrale (in alto)



Figura 49 – Momento flettente (SLU) del traverso intermedio (in basso) e del traverso dell'appoggio centrale (in alto)

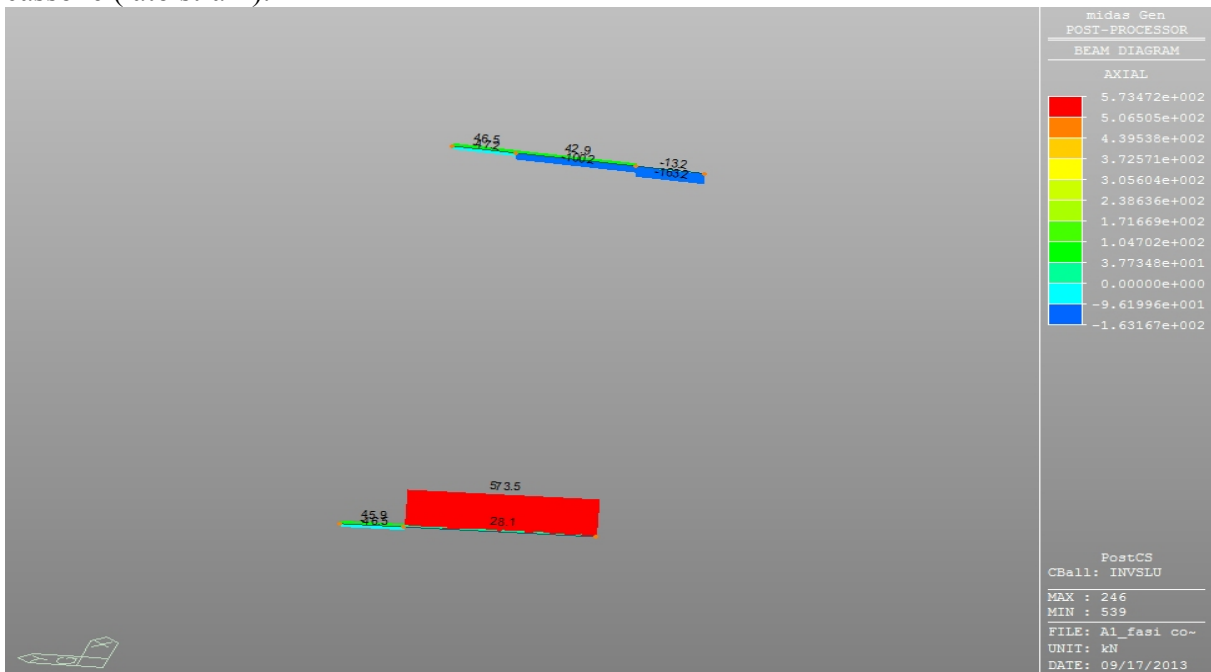

Figura 50 – Taglio (SLU) del traverso intermedio (in basso) e del traverso dell'appoggio centrale (in alto)

Di seguito, si riportano le immagini relative agli stati tensionali massimi per le verifiche di resistenza delle sezioni dei traversi.

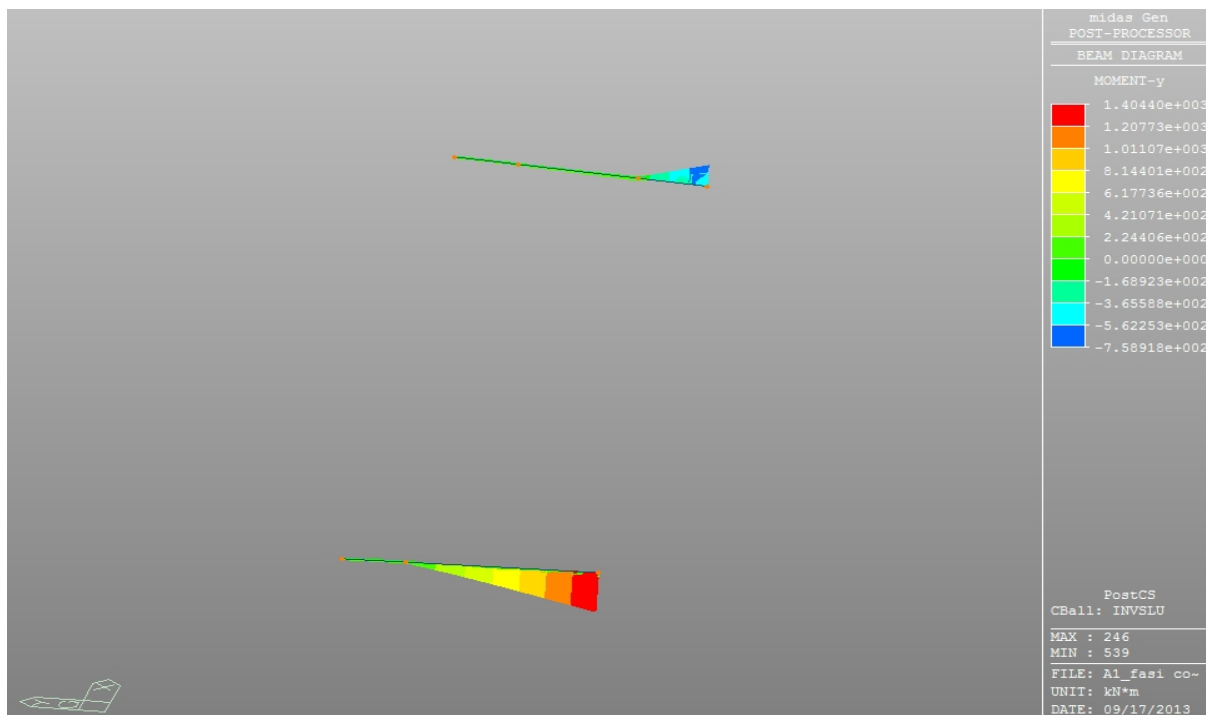

Figura 51 – Tensioni normali massime (SLU) del traverso intermedio (in basso) e del traverso dell'appoggio centrale (in alto)

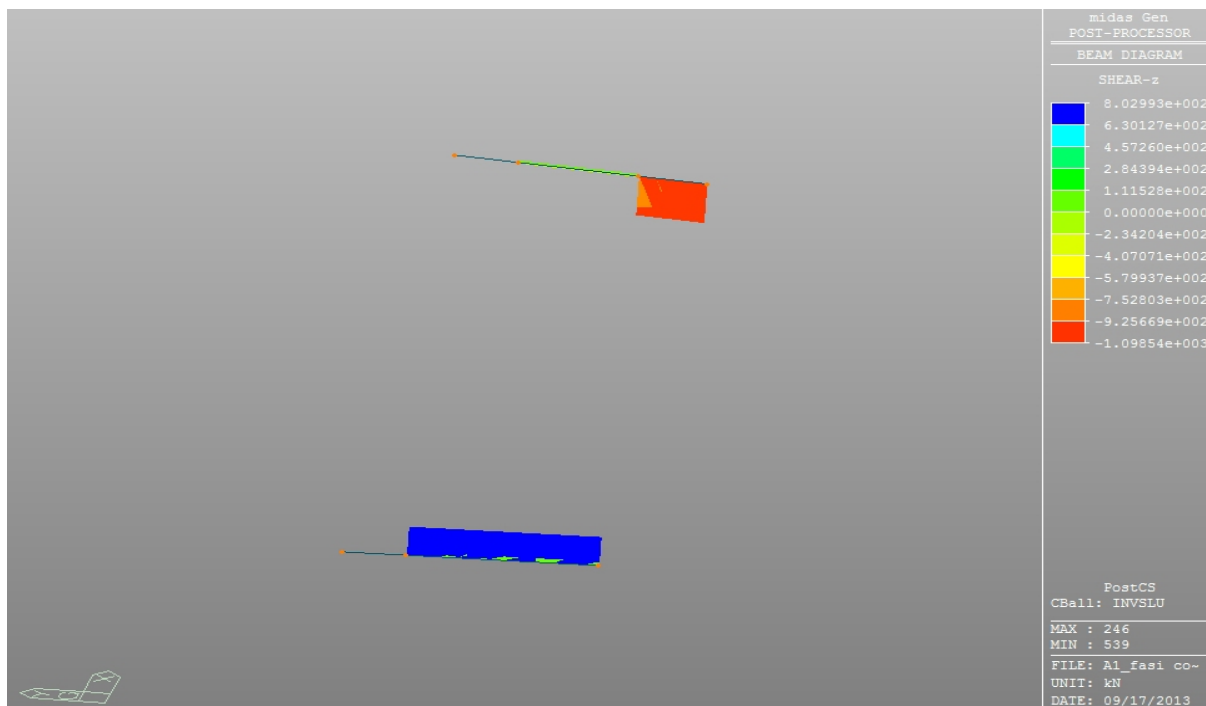

Figura 52 – Tensioni tangenziali massime (SLU) del traverso intermedio (in basso) e del traverso dell'appoggio centrale (in alto)

Dalle verifiche condotte si evince il rispetto della (1) in ogni punto delle strutture dell'impalcato.

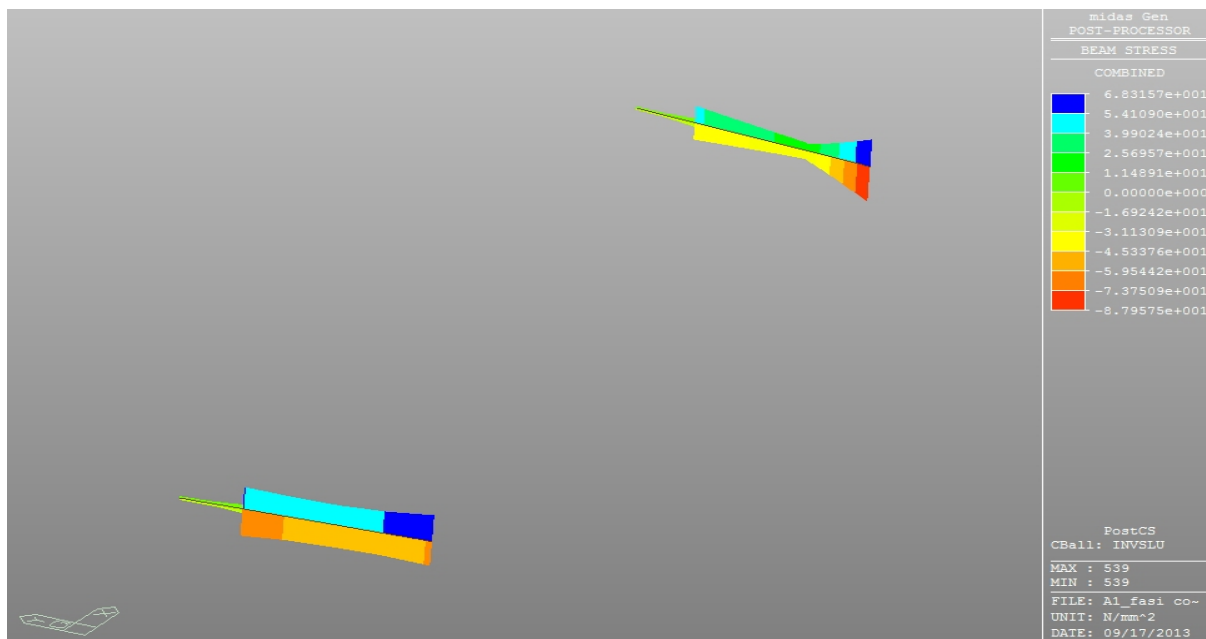
Si è considerata anche una condizione di carico eccezionale corrispondente alla disattivazione di uno strallo (rottura o sostituzione strallo) che comporta una redistribuzione degli sforzi agenti. Si riporta, di seguito, la verifica più gavosa riscontrata, corrispondente alla disattivazione dello strallo denominato "I4" (il quarto a partire dall'antenna).

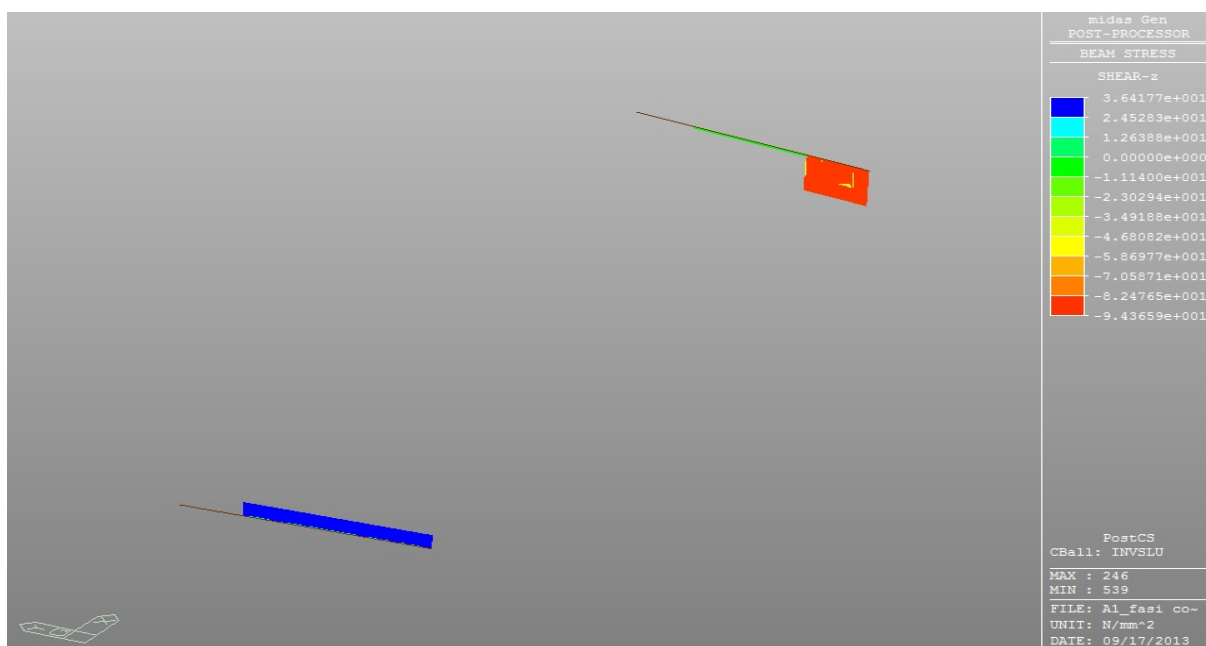

Figura 53 – Tensioni ideali (SLU) per la sezione in corrispondenza dell'appoggio centrale



Figura 54 – Tensioni ideali (SLU) per la sezione in campata

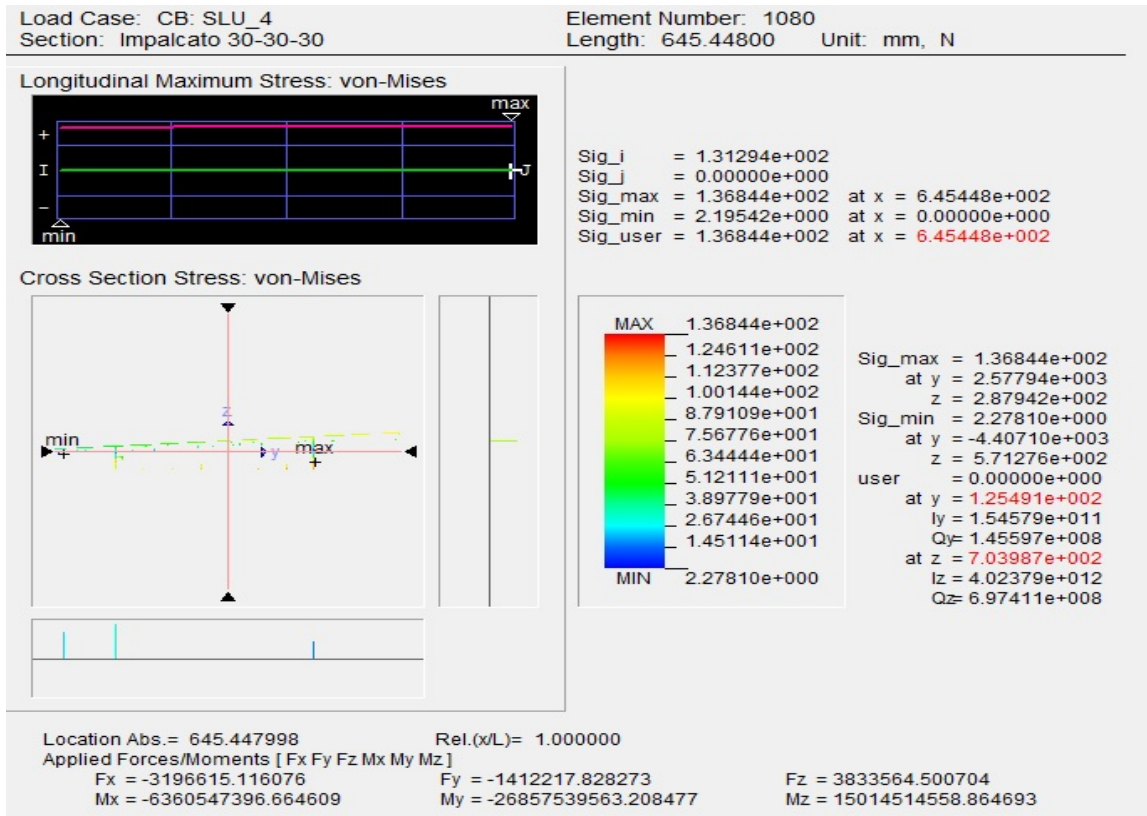

Figura 55 – Tensioni ideali (SLU) per la sezione in campata in corrispondenza dei fori di ispezione

Si osserva che a vantaggio di sicurezza si sono considerati i coefficienti di combinazione dei carichi γ non unitari come invece previsto da NTC2008 per verifiche di tipo eccezionali.

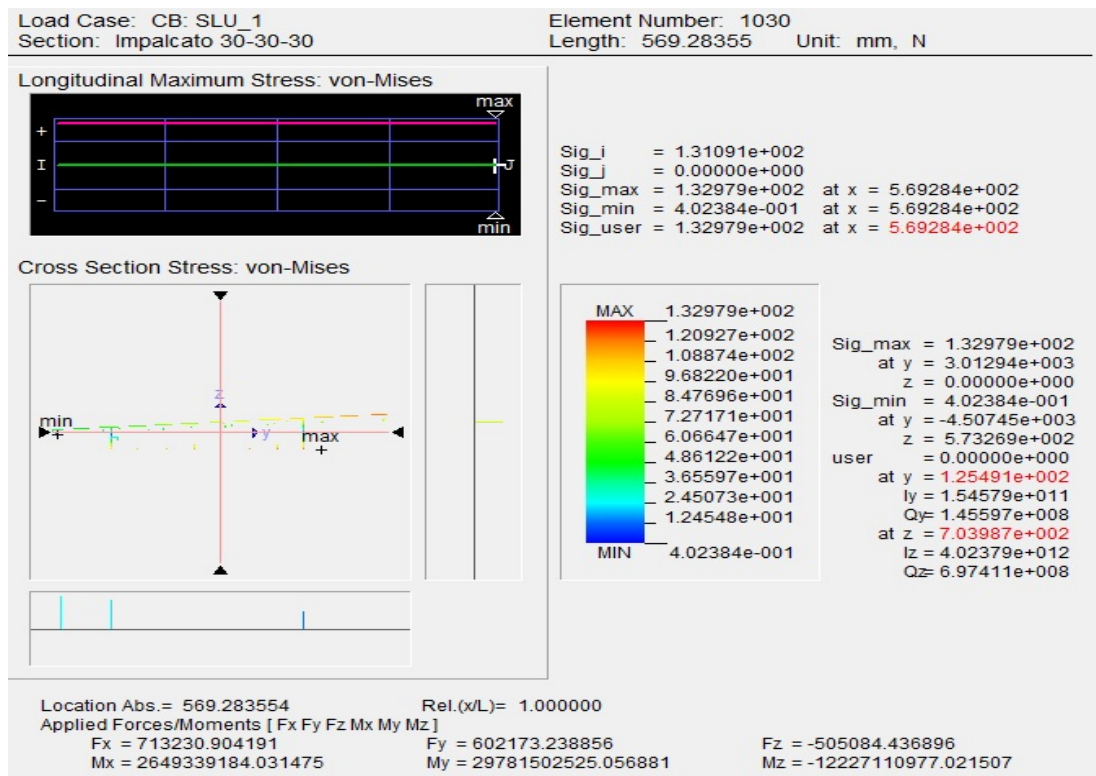
9. Verifiche della pila, dell'antenna e degli stralli

9.1 Premessa

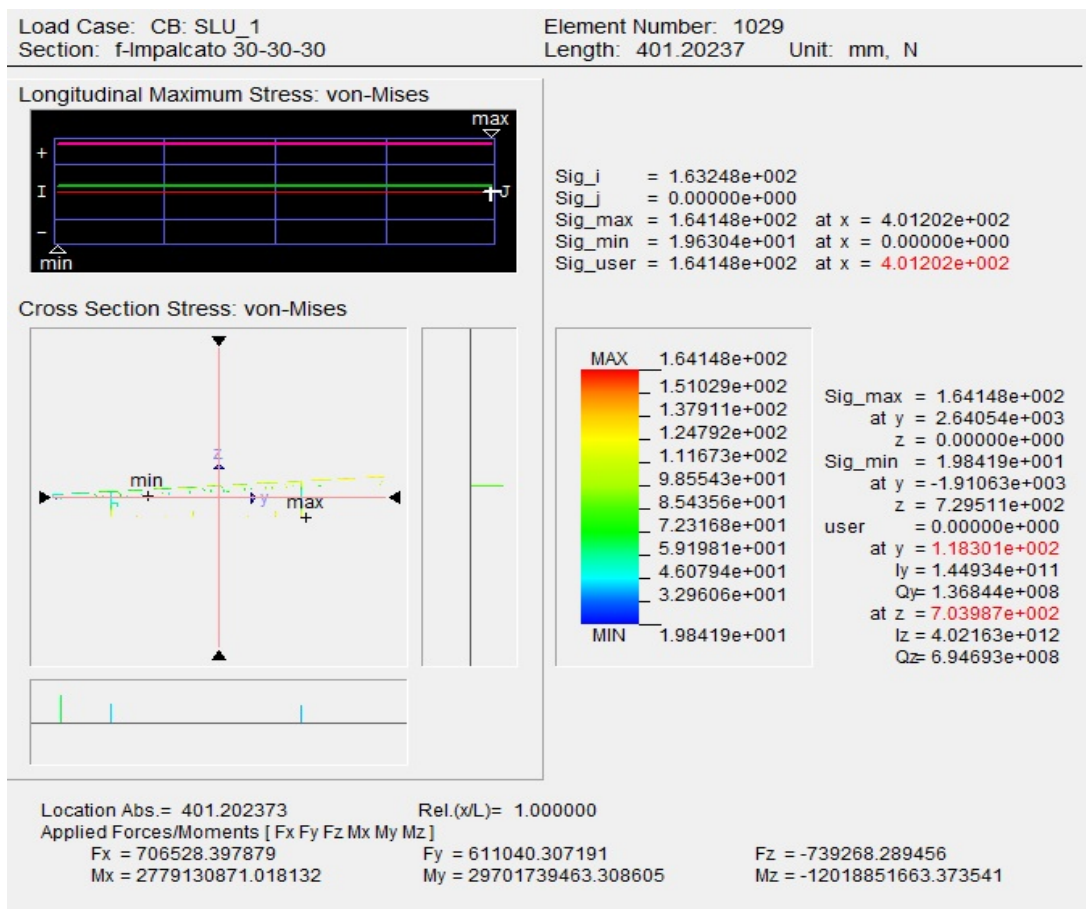
Di seguito, vengono presentate le verifiche di resistenza alle strutture della pila centrale, dell'antenna e degli stralli. Le verifiche sono state effettuate per tutte le membrature e per le combinazioni delle sollecitazioni di cui al par.7.2. Per brevità, si riportano le sole verifiche più gravose.

Per le verifiche delle pile di estremità si rimanda alle relazioni di calcolo delle rampe adiacenti al ponte strallato.

Per gli elementi in c.a., sono state condotte verifiche a presso-flessione o tenso-flessione deviata, controllando che:

$$M_{Rd} = M_{Rd}(N_{Ed}) \geq M_{Ed}$$

dove:

M_{Rd} è il valore di calcolo del momento resistente corrispondente a N_{Ed} ;

M_{Ed} è il valore di calcolo della componente flettente dell'azione.

Allo stesso modo per le verifiche a taglio occorre verificare che:

$$V_{Rd} \geq V_{Ed}$$

dove:

V_{Rd} è il valore di calcolo del taglio resistente;

V_{Ed} è il valore di calcolo della componente tagliante dell'azione.

Avendo utilizzato $q=1$ per le azioni sismiche non occorre applicare G.R.

9.2 Verifiche di resistenza della pila centrale

Di seguito si riportano le verifiche più gravose a pressoflessione deviata e taglio della pila centrale. Le verifiche sono condotte in corrispondenza della zona critica corrispondente alla sezione di attacco in fondazione (BxH=180x986cm) armata con 1+1 ϕ 20/15 lungo i lati lunghi e 6 ϕ 26 (rapporto geometrico $\rho=1.4\%$) in corrispondenza delle testate sui lati corti.

Verifica a pressoflessione deviata

Combinazione di Carico 46: SLV6x

Verifica a taglio in direzione y (lato H)

Combinazione di Carico: SLV7y

Materiali		Geometria sezione		Armatura longitudinale		Sollecitazioni di calcolo		
Calcestruzzo		b [mm]	1800	n° barre	20	N _{Ed} [kN]	0	Comb.
Rck [Mpa]	40	h [mm]	9860	diametro	26	V _{Ed} [kN]	4553	SLV7y
fck [Mpa]	33.2	c [mm]	90	Area [mm ²]	10613.2			
ffd [Mpa]	18.8	d [mm]	9770					
Acciaio				Armatura trasversale		VERIFICA		
fyk [Mpa]	450			Staffe Φ	12	Sezione non armata a taglio		
fyd [Mpa]	391.3			n° bracci	2	V _{Rd} [kN]	4334.28	
				A _{sw} [mm ²]	226.08	Armata!!!		
				s [mm]	200	Sezione armata a taglio		
						Crisi armatura a taglio		
k	1.14					V _{Rd} [kN]	9723.53	
v _{min}	0.25					V _{Rcd} [kN]	51338.99	
ρ _l	0.0006							
σ _{cp}	0.0000					V _{Rd} [kN]	9723.53	
ν	0.5					Verificato		
(σ _{cp}) [*]	0							
α _c	1							
ω _{sw}	0.013							
cotgθ	6.106							
cotgθ [*]	2.500							

9.3 Verifiche di resistenza dell'antenna

Di seguito, si riportano alcune immagini relative alle caratteristiche della sollecitazione agenti, relative agli involuipi delle combinazioni SLU e SLV.



Figura 56 – Sforzo normale (SLU)



Figura 57 – Momenti flettenti asse y (SLU)

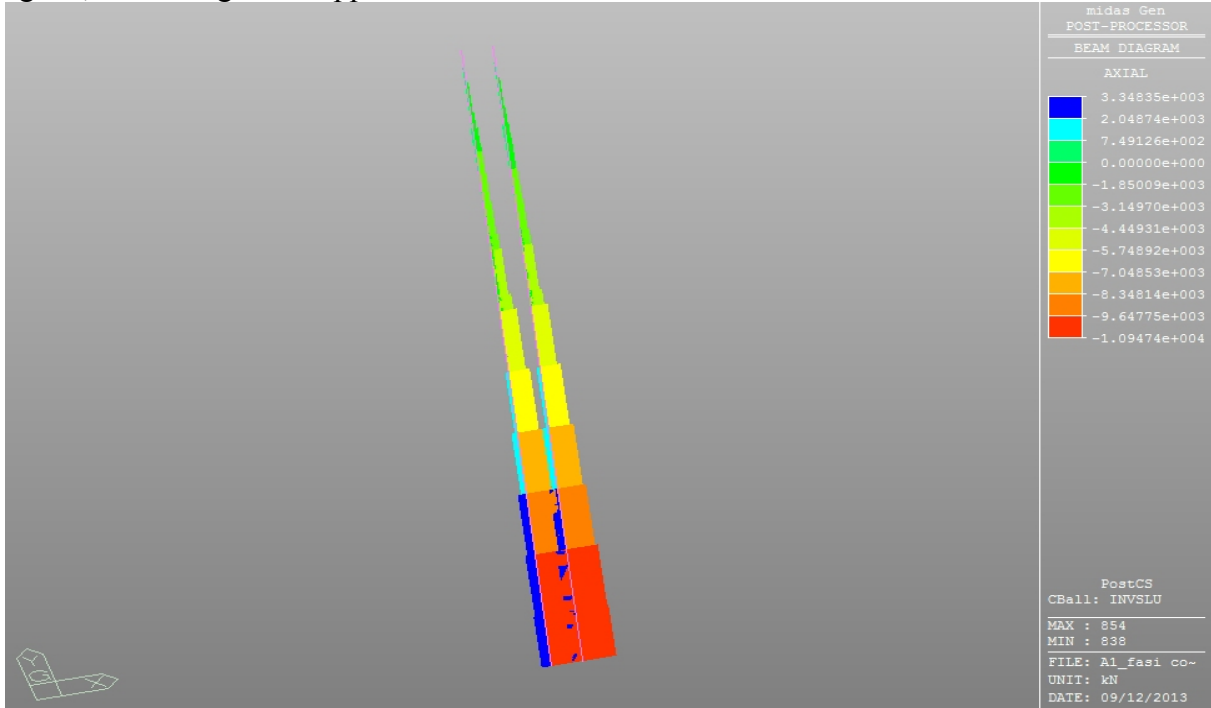

Figura 58 – Momenti flettenti asse z (SLU)

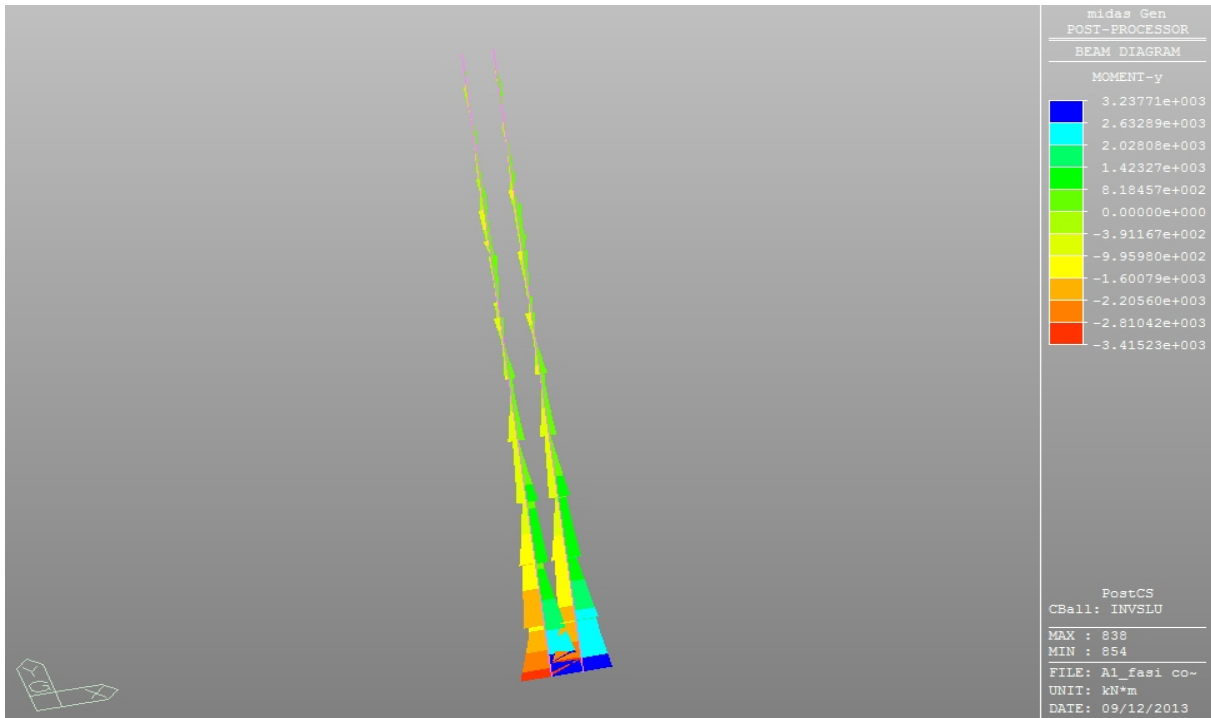

Figura 59 – Tagli asse y (SLU)

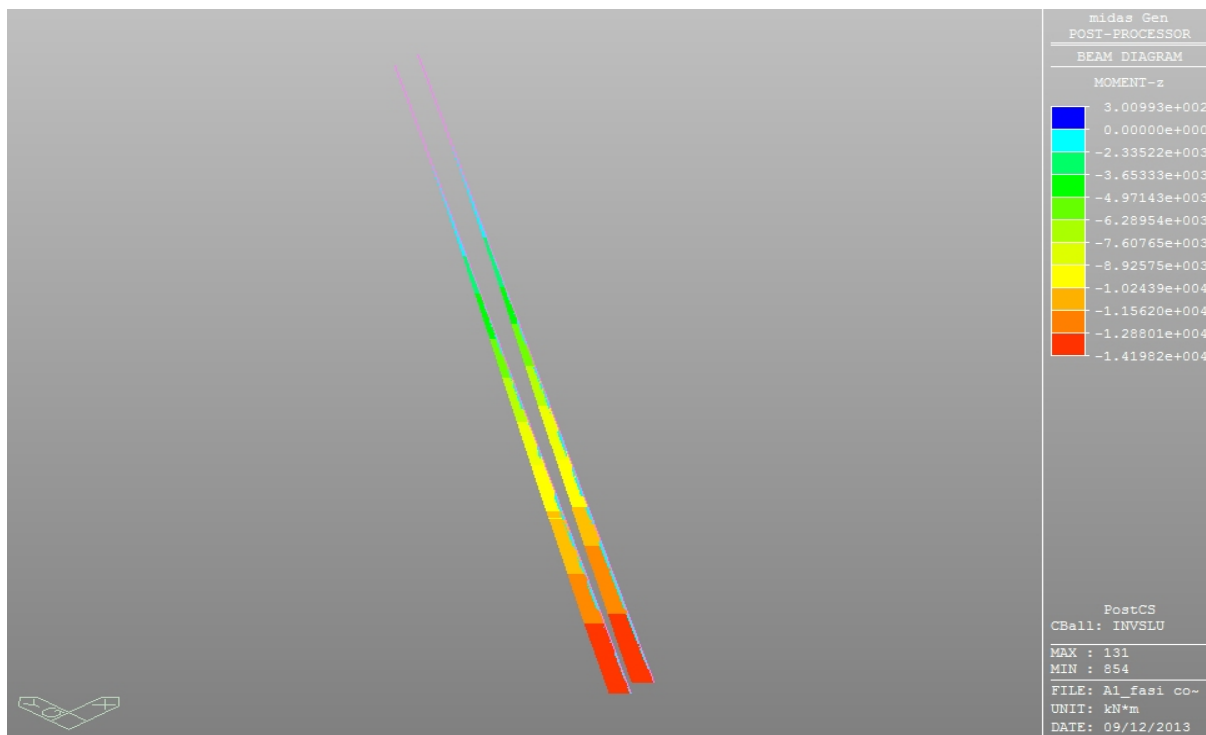

Figura 60 – Tagli asse z (SLU)

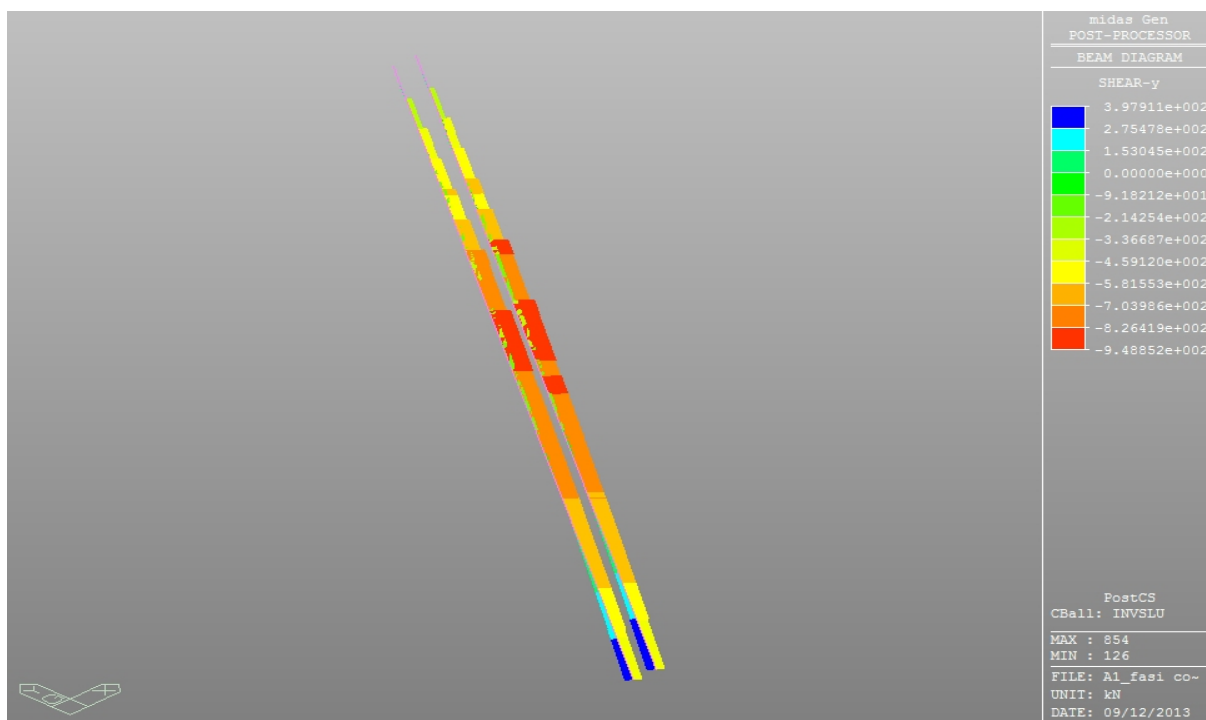

Figura 61 – Sforzo normale (SLV)

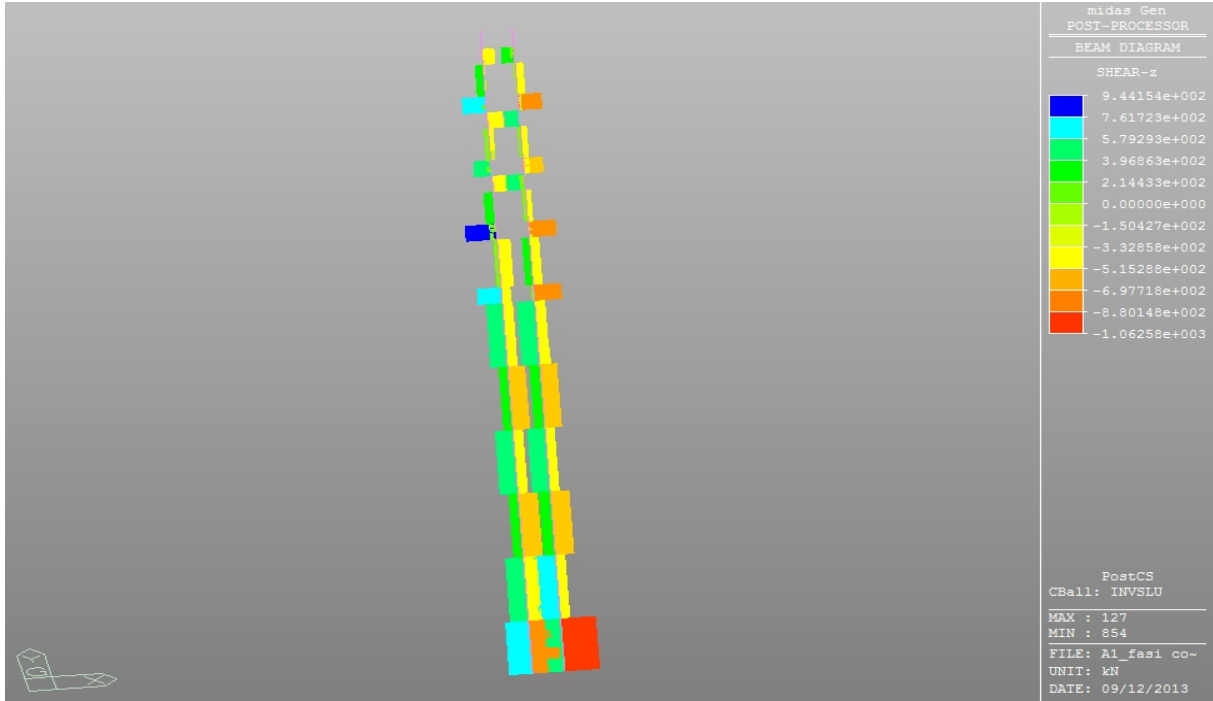

Figura 62 – Momenti flettenti asse y (SLV)

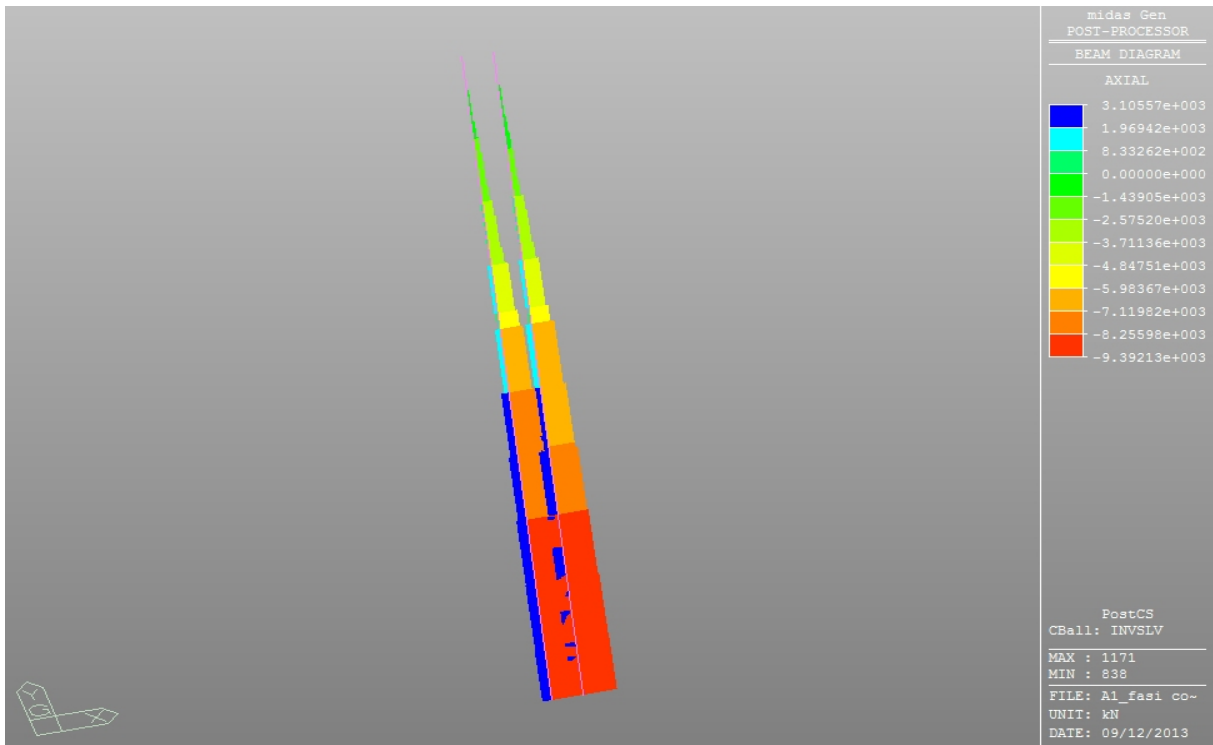

Figura 63 – Momenti flettenti asse z (SLV)

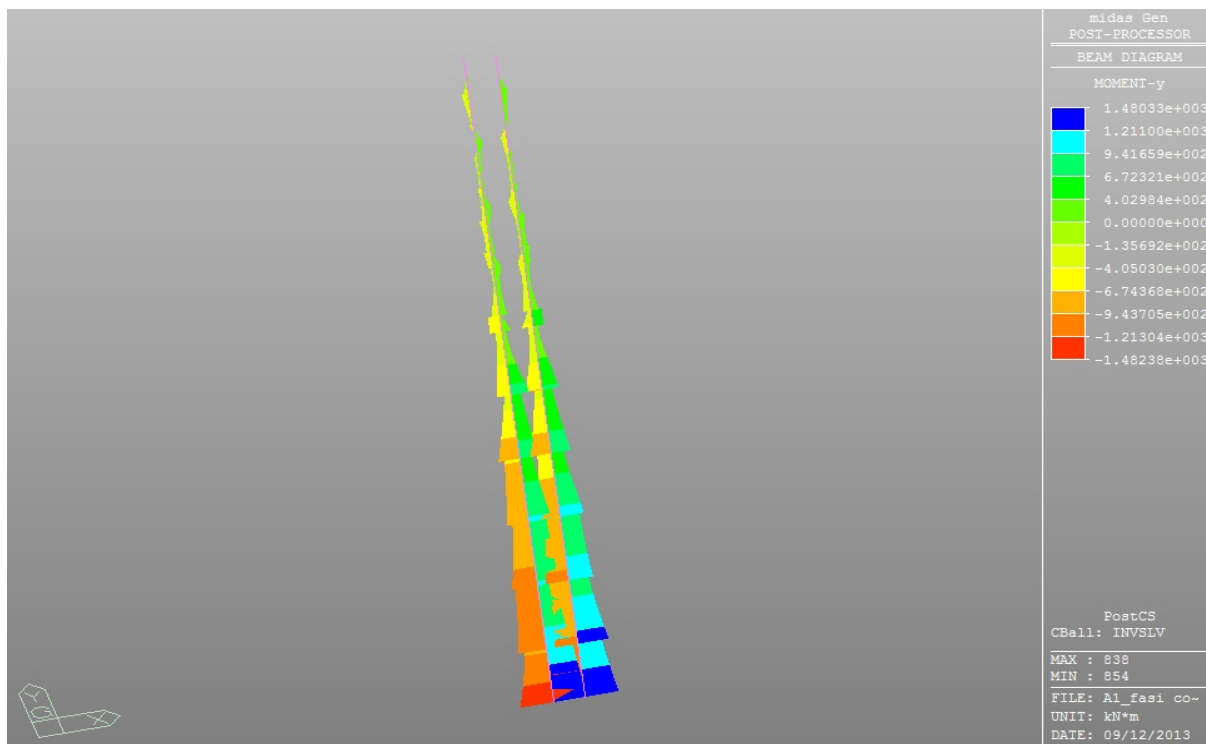

Figura 64 – Tagli asse y (SLV)

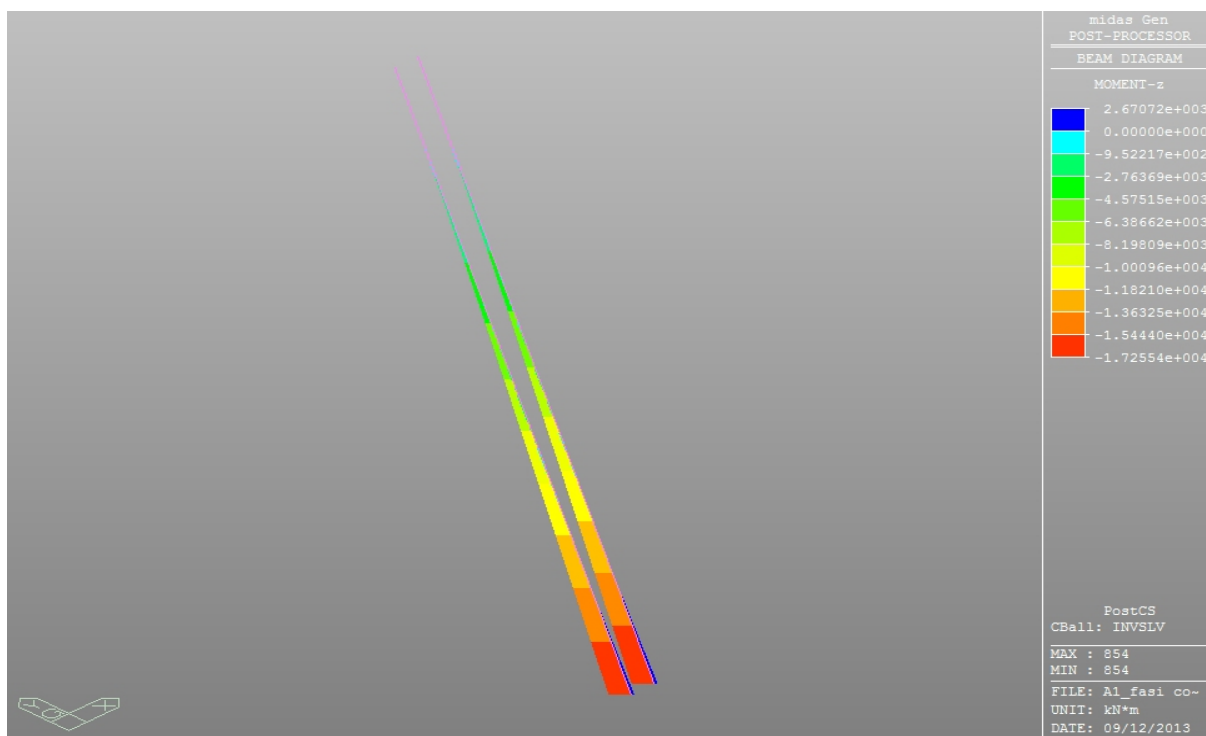

Figura 65 – Tagli asse z (SLV)

Nel calcolo delle sollecitazioni si sono considerati solo gli effetti del primo ordine in quanto quelli di ordine superiore sono trascurabili, data la geometria adottata per la sezione trasversale dell'antenna (rigidezza laterale) e l'entità degli spostamenti. In particolare, non si conduce la verifica di instabilità, avendo verificato che la snellezza della colonna (λ) è inferiore al valore della snellezza limite (λ_{lim}).

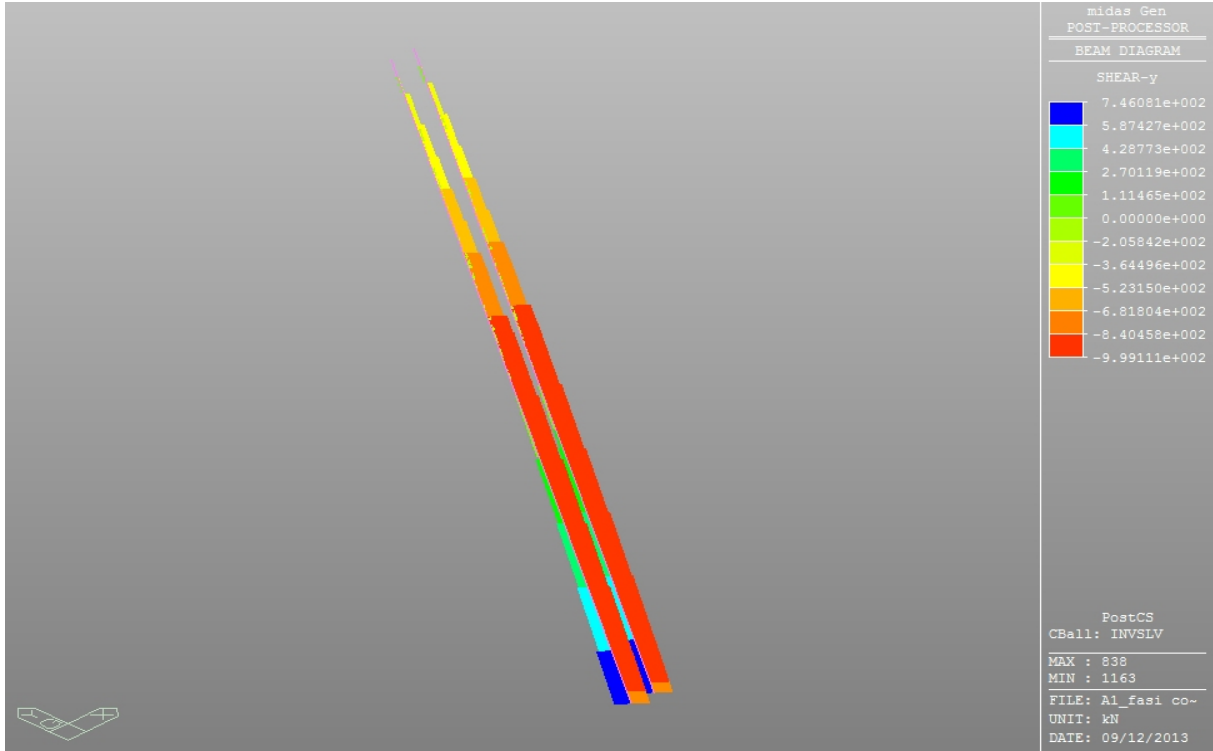
$$\lambda = 65 \leq \lambda_{lim} = 70$$

dove:

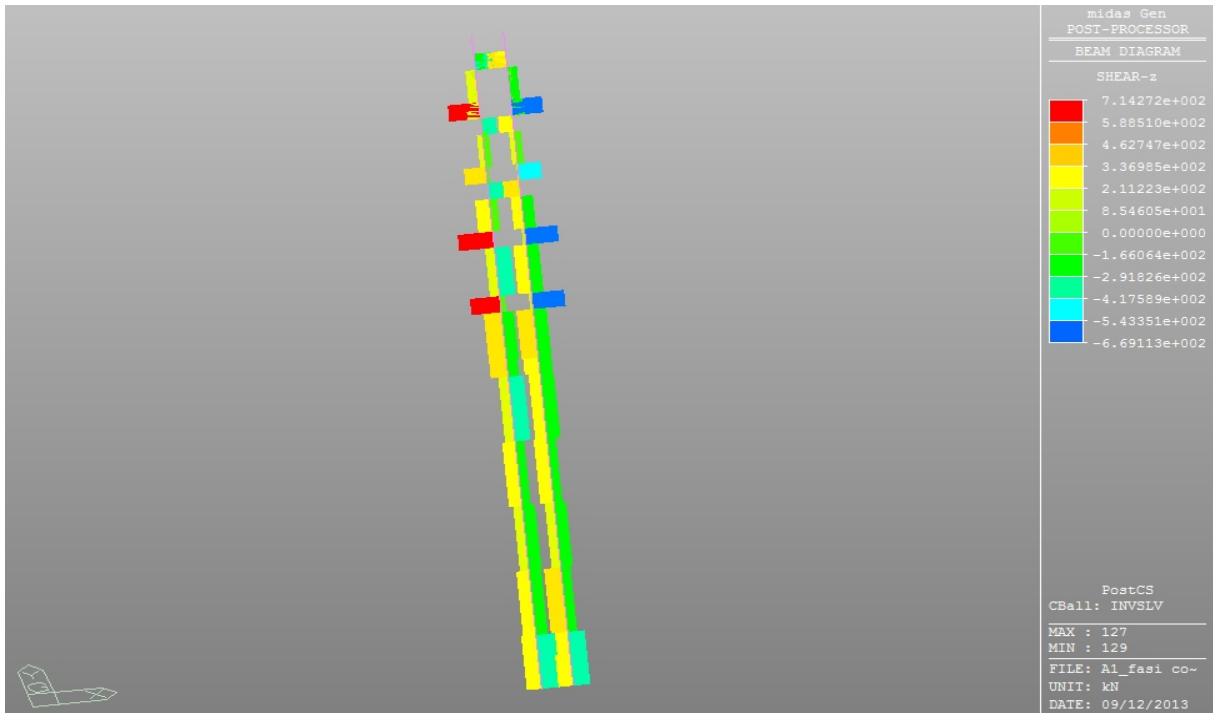
$\lambda = 2L/\rho_{min}$ essendo: $L=24.3m$, $\rho_{min}=74.7cm$ (raggio di inerzia minimo della sezione media)
 $\lambda_{lim}=15.4 C/\sqrt{v}$ essendo: $C=1.7$, $v= N_{ed}/(A_c \cdot f_{cd}) = 0.14$ (azione assiale adimensionale)

Di seguito si riportano le verifiche più gravose a pressoflessione deviata e taglio della sezione in c.a. dell'antenna. Le verifiche sono condotte a pressoflessione in corrispondenza della zona critica corrispondente alla sezione di attacco sulla pila (BxH=350x130cm) armata con 83 ϕ 24 (rapporto geometrico $\rho=1.7\%$). Mentre a taglio, oltre alla sezione di base, sono risultate più gravose le verifiche della sezione a quota 425.76m (quota primo strallo) in direzione x (lato B) e la sezione a quota 432.29m (quota penultimo strallo) in direzione y (lato H). Vengono poi presentate le verifiche di resistenza delle strutture in acciaio di collegamento che formano la colonna tralicciata dell'antenna.

Verifica a pressoflessione deviata

Combinazione di Carico 54: SLV6y

Combinazione di Carico: 54

- N : -93325.3 [kg]
- Mx : 54793.2 [kgm]
- My : 1739659.5 [kgm]

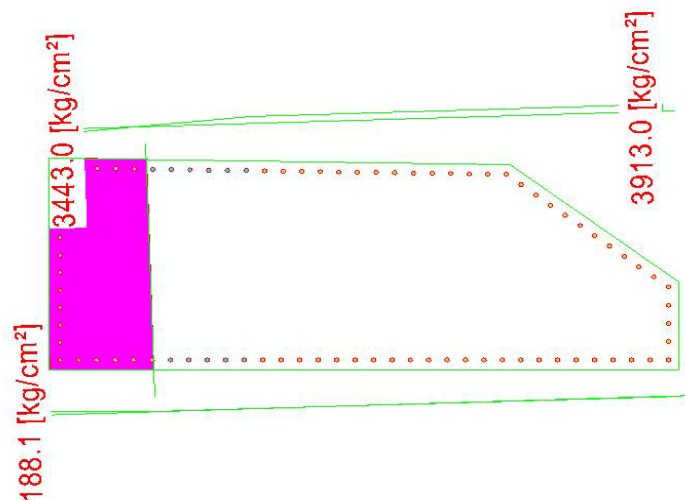

Azioni Resistenti:

- N : -121028.0 [kg]
- Mx : 71058.0 [kgm]
- My : 2256059.7 [kgm]
- Moltiplicatore dei carichi 0.771105

Verifica a taglio in direzione x (lato B)-sezione a quota 425.76m
Combinazione di Carico: SLU53

Materiali		Geometria sezione		Armatura longitudinale		Sollecitazioni di calcolo		
Calcestruzzo		b [mm]	760	n° barre	7	N_{Ed} [kN]	0	Comb.
Rck [Mpa]	40	h [mm]	2490	diametro	24	V_{Ed} [kN]	949	SLU53
fck [Mpa]	33.2	c [mm]	60	Area [mm ²]	3165.12			
fed [Mpa]	18.8	d [mm]	2430					
Acciaio				Armatura trasversale				
fyk [Mpa]	450			Staffe Φ	12			
fyd [Mpa]	391.3			n° bracci	2			
				A_{sw} [mm ²]	226.08			
				s [mm]	200			
				VERIFICA				
				Sezione non armata a taglio				
				V_{Rd} [kN]				
				543.71				
				Armatura!!!				
				Sezione armata a taglio				
				Crisi armatura a taglio				
				V_{Rsd} [kN]				
				2418.44				
				V_{Rcd} [kN]				
				5391.38				
				V_{Ed} [kN]				
				2418.44				
				Verificato				
k	1.29							
v_{min}	0.29							
ρ_l	0.0017							
σ_{cp}	0.0000							
v'	0.5							
$(\sigma_{cp})^*$	0							
α_c	1							
ω_{sw}	0.031							
cotg θ	3.894							
cotg θ^*	2.500							

Verifica a taglio in direzione y (lato H)-sezione a quota 432.29m
Combinazione di Carico: SLU53

Materiali		Geometria sezione		Armatura longitudinale		Sollecitazioni di calcolo		
Calcestruzzo		b [mm]	2000	n° barre	14	N_{Ed} [kN]	0	Comb.
Rck [Mpa]	40	h [mm]	490	diametro	26	V_{Ed} [kN]	720	SLU53
fck [Mpa]	33.2	c [mm]	60	Area [mm ²]	7429.24			
fed [Mpa]	18.8	d [mm]	430					
Acciaio				Armatura trasversale				
fyk [Mpa]	450			Staffe Φ	12			
fyd [Mpa]	391.3			n° bracci	4			
				A_{sw} [mm ²]	452.16			
				s [mm]	200			
				VERIFICA				
				Sezione non armata a taglio				
				V_{Rd} [kN]				
				531.33				
				Armatura!!!				
				Sezione armata a taglio				
				Crisi armatura a taglio				
				V_{Rsd} [kN]				
				855.91				
				V_{Rcd} [kN]				
				2510.61				
				V_{Ed} [kN]				
				855.91				
				Verificato				
k	1.68							
v_{min}	0.44							
ρ_l	0.0086							
σ_{cp}	0.0000							
v'	0.5							
$(\sigma_{cp})^*$	0							
α_c	1							
ω_{sw}	0.024							
cotg θ	4.502							
cotg θ^*	2.500							

Verifiche di resistenza dei controventi in acciaio: 2UPN220

midas Gen

Steel Checking Result

	Company		Project Title	
	Author	Massimo Di Placido	File Name	P:\...A1_fasi costruttive-rev8.mgb

1. Design Information

Design Code Eurocode3:05
 Unit System kN, m
 Member No 1181
 Material S355 (No:2)
 (Fy = 355000, Es = 210000000)
 Section Name 2UPN220 (No:85)
 (Built-up Section).
 Member Length : 2.60000

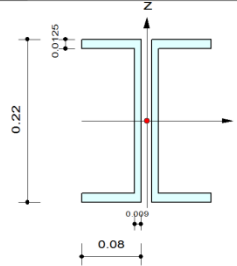

2. Member Forces

Axial Force Fxx = -1543.0 (LCB: 15-, POS:1/2)
 Bending Moments My = 0.22942, Mz = -0.2813
 End Moments Myi = 0.00000, Myj = 0.00000 (for Lb)
 Mzi = 0.00000, Mzj = 0.00000 (for Lz)
 Shear Forces Fyy = -0.7946 (LCB: 68, POS:J)
 Fzz = 0.40455 (LCB: 19+, POS:J)

Depth	0.22000	Web Thick	0.00900
Flg Width	0.08000	Flg Thick	0.01250
BTB Spacing	0.01600		
Area	0.00751	Asz	0.00396
Qyb	0.01628	Qzb	0.00320
Iyy	0.00005	Izz	0.00001
Ybar	0.08800	Zbar	0.11000
Wely	0.00049	Welz	0.00014
ry	0.08498	rz	0.03984

3. Design Parameters

Unbraced Lengths Ly = 2.60000, Lz = 2.60000, Lb = 2.60000
 Effective Length Factors Ky = 1.00, Kz = 1.00
 Equivalent Uniform Moment Factors Cmy = 1.00, Cmz = 1.00, CmLT = 1.00

4. Checking Results

Axial Resistance

$N_{Ed}/N_{c,Rd} = 1542.99/1595.30 = 0.967 < 1.000$ O.K

Bending Resistance

$M_{Edy}/M_{Rdy} = 0.229/198.162 = 0.001 < 1.000$ O.K

$M_{Edz}/M_{Rdz} = 0.2813/79.7482 = 0.004 < 1.000$ O.K

Combined Resistance

$RNRd = \text{MAX}[M_{Edy}/M_{ny,Rd}, M_{Edz}/M_{nz,Rd}]$

$R_{max1} = (M_{Edy}/M_{ny,Rd})^{\alpha} + (M_{Edz}/M_{nz,Rd})^{\beta}$

$R_{com} = N_{Ed}/(A \cdot f_y / \gamma_{M0}), R_{bend} = M_{Edy}/M_{y,Rd} + M_{Edz}/M_{z,Rd}$

$R_{c_LT1} = N_{Ed}/(X_{iy} \cdot A \cdot f_y / \gamma_{M1})$

$R_{b_LT1} = (k_{yy} \cdot M_{Edy}) / (X_{i_LT} \cdot W_{ply} \cdot f_y / \gamma_{M1}) + (k_{yz} \cdot M_{sdz}) / (W_{plz} \cdot f_y / \gamma_{M1})$

$R_{c_LT2} = N_{Ed}/(X_{iz} \cdot A \cdot f_y / \gamma_{M1})$

$R_{b_LT2} = (K_{zy} \cdot M_{Edy}) / (X_{i_LT} \cdot W_{ply} \cdot f_y / \gamma_{M1}) + (K_{zz} \cdot M_{sdz}) / (W_{plz} \cdot f_y / \gamma_{M1})$

$R_{max} = \text{MAX}[RNRd, R_{max1}, (R_{com} + R_{bend}), \text{MAX}(R_{c_LT1} + R_{b_LT1}, R_{c_LT2} + R_{b_LT2})] = 0.973 < 1.000$.. O.K

Shear Resistance

$V_{Edy}/V_{y,Rd} = 0.001 < 1.000$ O.K

$V_{Edz}/V_{z,Rd} = 0.001 < 1.000$ O.K

Verifiche di resistenza dei traversi in acciaio: tubo $\phi 219.1$ sp.12mm

midas Gen

Steel Checking Result

	Company		Project Title	
	Author	Massimo Di Placido	File Name	P:\...A1_fasi costruttive-rev8.mgb

1. Design Information

Design Code Eurocode3:05
 Unit System kN, m
 Member No 130
 Material S355 (No:2)
 (Fy = 355000, Es = 210000000)
 Section Name tubo219.1x12 (No:84)
 (Built-up Section).
 Member Length : 1.00000

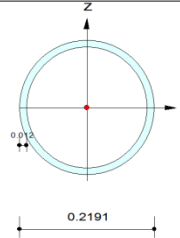

2. Member Forces

Axial Force Fxx = 545.103 (LCB: 19+, POS:I)
 Bending Moments My = 35.4010, Mz = 14.6786
 End Moments Myi = 35.4010, Myj = 38.7434 (for Lb)
 Myi = 35.4010, Myj = 38.7434 (for Ly)
 Mzi = 14.6786, Mzj = 0.40694 (for Lz)
 Shear Forces Fyy = 27.7442 (LCB: 12+, POS:I)
 Fzz = -79.829 (LCB: 13-, POS:I)

Outer Dia.	0.21910	Wall Thick	0.01200
Area	0.00781	Asz	0.00390
Qyb	0.01076	Qzb	0.01076
Iyy	0.00004	Izz	0.00004
Ybar	0.10955	Zbar	0.10955
Wely	0.00038	Welz	0.00038
ry	0.07334	rz	0.07334

3. Design Parameters

Unbraced Lengths Ly = 1.00000, Lz = 1.00000, Lb = 1.00000
 Effective Length Factors Ky = 1.00, Kz = 1.00
 Equivalent Uniform Moment Factors Cmy = 1.00, Cmz = 1.00, CmLT = 1.00

4. Checking Results

Axial Resistance
 $N_{Ed}/N_{tRd} = 545.10/2639.67 = 0.207 < 1.000$ O.K
 Bending Resistance
 $M_{Edy}/M_{Rdy} = 35.401/174.207 = 0.203 < 1.000$ O.K
 $M_{Edz}/M_{Rdz} = 14.679/174.207 = 0.084 < 1.000$ O.K
 Combined Resistance
 $RNRd = \text{MAX}[M_{Edy}/M_{nyRd}, M_{Edz}/M_{nzRd}]$
 $R_{max1} = (M_{Edy}/M_{nyRd})^{\text{Alpha}} + (M_{Edz}/M_{nzRd})^{\text{Beta}}$
 $R_{com} = N_{Ed}/(A \cdot f_y / \text{Gamma}_{M0})$, $R_{bend} = M_{Edy}/M_{yRd} + M_{Edz}/M_{zRd}$
 $R_{max} = \text{MAX}[RNRd, R_{max1}, (R_{com} + R_{bend})] = 0.494 < 1.000$ O.K
 Shear Resistance
 $V_{Edy}/V_{yRd} = 0.029 < 1.000$ O.K
 $V_{Edz}/V_{zRd} = 0.082 < 1.000$ O.K

5. Deflection Checking Results

$L/250.0 = 0.0040 > 0.0001$ (Memb:112, LCB: 148, POS: 0.5m, Dir-Z)..... O.K

9.4 Verifiche di resistenza degli stralli

Di seguito, si riportano alcune immagini relative alle caratteristiche della sollecitazione relativi agli involuipi SLU e SLV.



Figura 66 – Sforzi di trazione (SLU)



Figura 67 – Sforzi di trazione (SLV)

Pertanto, essendo gli stralli realizzati con 31 trefoli ($A_s = 31 \cdot 150 \text{mm}^2$), si ha:

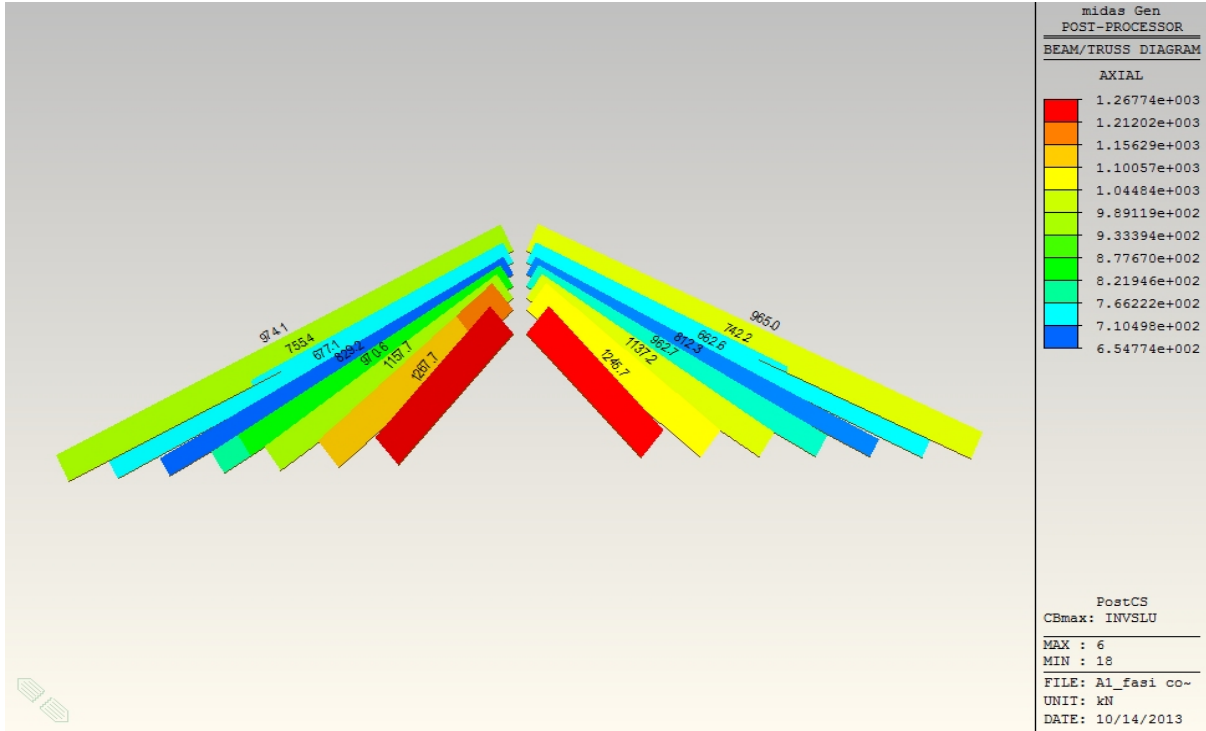
$$T_{ed} = 1268 \text{kN} < A_s \cdot f_{pyd} = 31 \cdot 150 \cdot 1452 / 1000 = 6751 \text{kN}$$

Il coefficiente di sicurezza superiore a 5 è dovuto al fatto che il dimensionamento degli stralli è governato dalla deformabilità dell'impalcato, ovvero si sono dovuti adottare stralli di rigidità maggiore per ridurre gli spostamenti verticali dell'impalcato a valori accettabili.

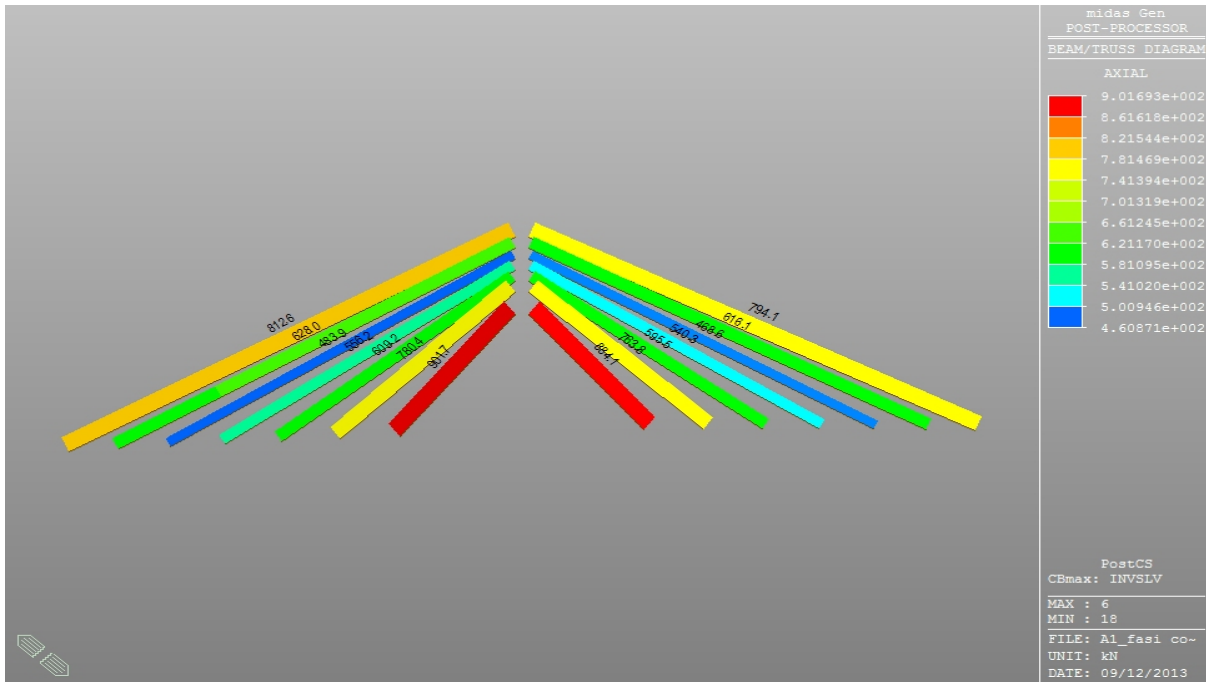
Si è considerata anche una condizione di carico eccezionale corrispondente alla disattivazione di uno strallo (rottura o sostituzione strallo) che comporta una redistribuzione degli sforzi agenti. Si riporta, di seguito, la verifica più gavosa riscontrata, corrispondente alla disattivazione dello strallo denominato "I6" (il secondo a partire dall'antenna).



Figura 68 – Sforzi di trazione per disattivazione strallo "I6" (SLU)

Pertanto, la verifica:

$$T_{ed} = 1556 \text{kN} < A_s \cdot f_{pyd} = 31 \cdot 150 \cdot 1452 / 1000 = 6751 \text{kN}$$

Si osserva che a vantaggio di sicurezza si sono considerati i coefficienti di combinazione dei carichi γ non unitari come invece previsto da NTC2008 per verifiche di tipo eccezionali.

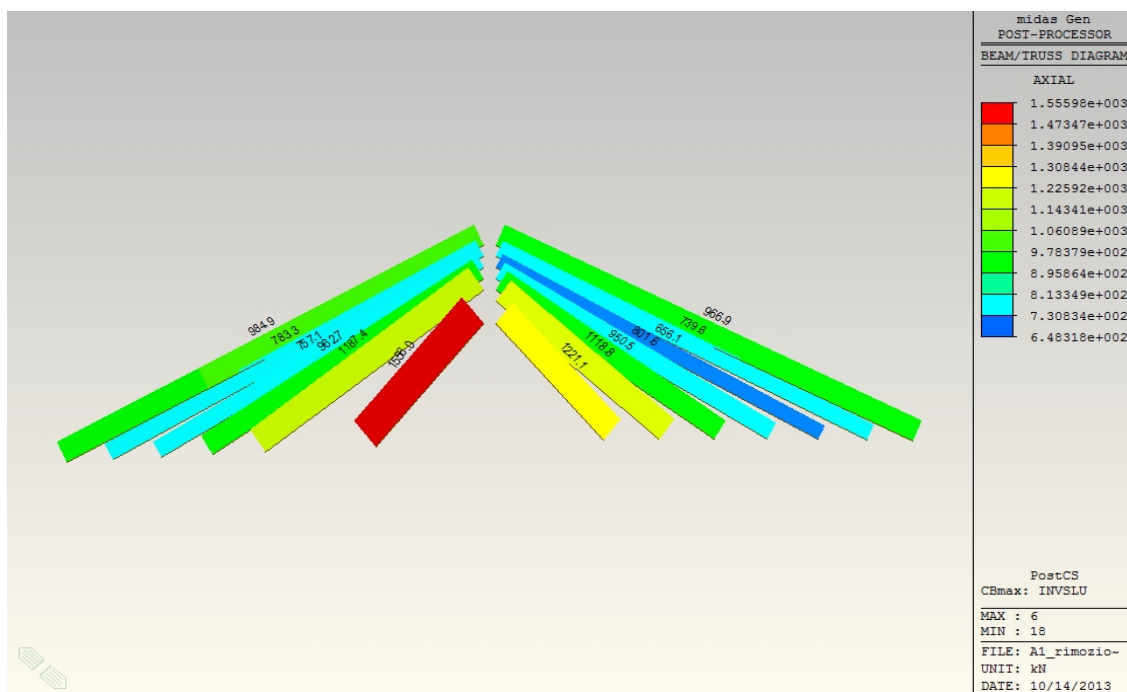
10. Verifiche di deformazione e reazioni agli appoggi

10.1 Verifica di deformazione impalcato

Di seguito, si riportano le immagini relative alle deformate di impalcato per le combinazioni SLE rara, per i carichi veicolari e per le fasi costruttive.



Figura 69 –Spostamenti verticali dell'impalcato (SLE rara)



Figura 70 –Spostamenti verticali dell'impalcato per i carichi veicolari

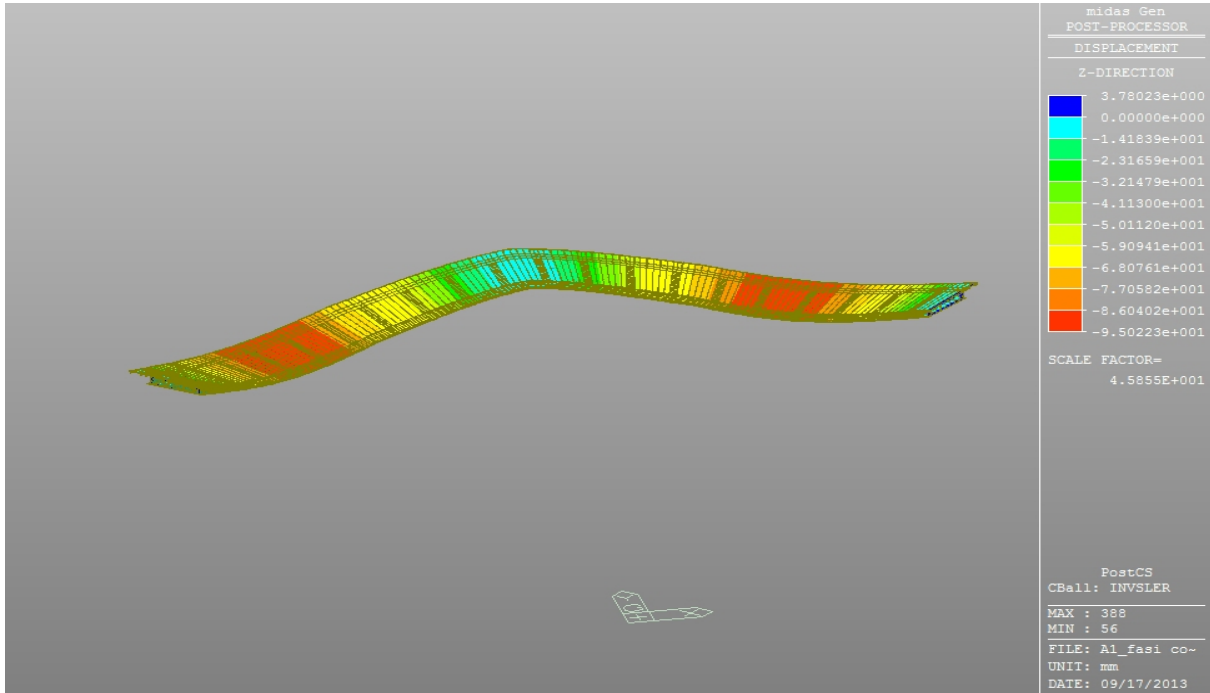

Figura 71 – Fase 1: Spostamenti verticali dei conchi di impalcato per i pesi propri

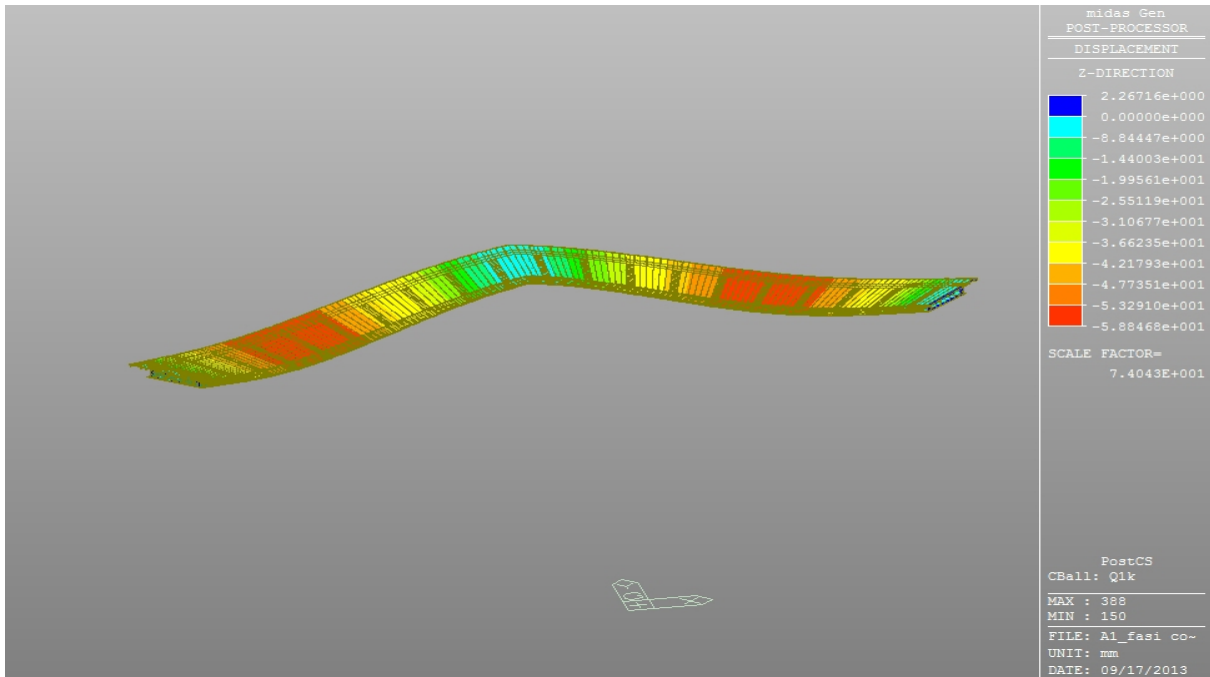

Figura 72 – Fase 4: Spostamenti verticali dell' impalcato a rimozione dei puntelli provvisori ed applicazione dei sovraccarichi permanenti

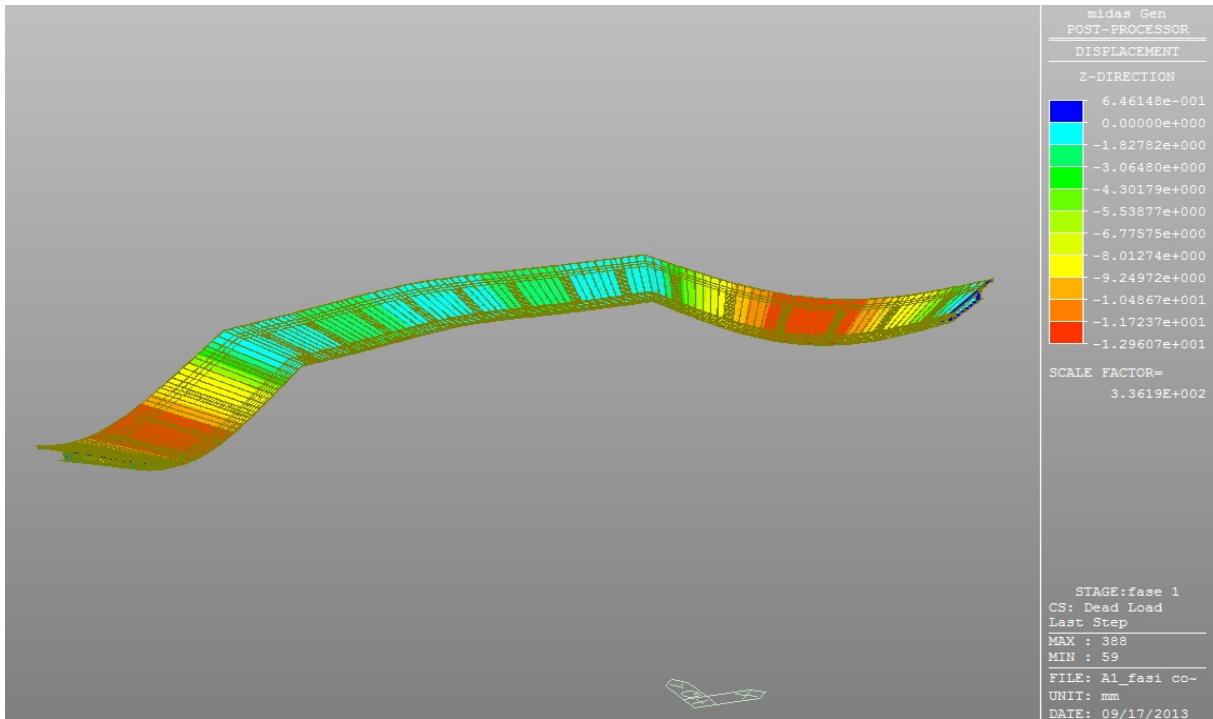

Figura 73 – Fase 4: Spostamenti verticali dell' impalcato a seguito della pretensione degli stralli

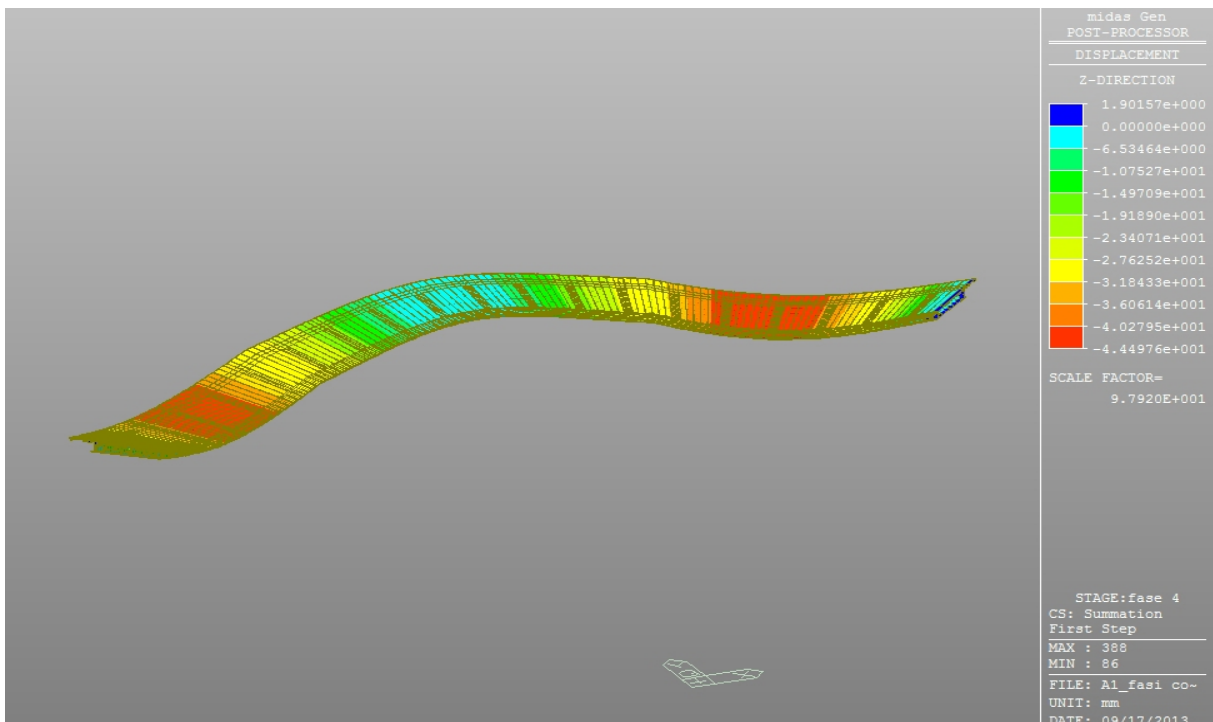

Figura 74 – Fase 4: Spostamenti verticali dell'impalcato a lungo termine per effetto delle deformazioni finali da ritiro e viscosità del calcestruzzo dell'antenna

Come si evince dalle immagini precedenti il massimo spostamento verticale per effetto dei carichi veicolari è pari a:

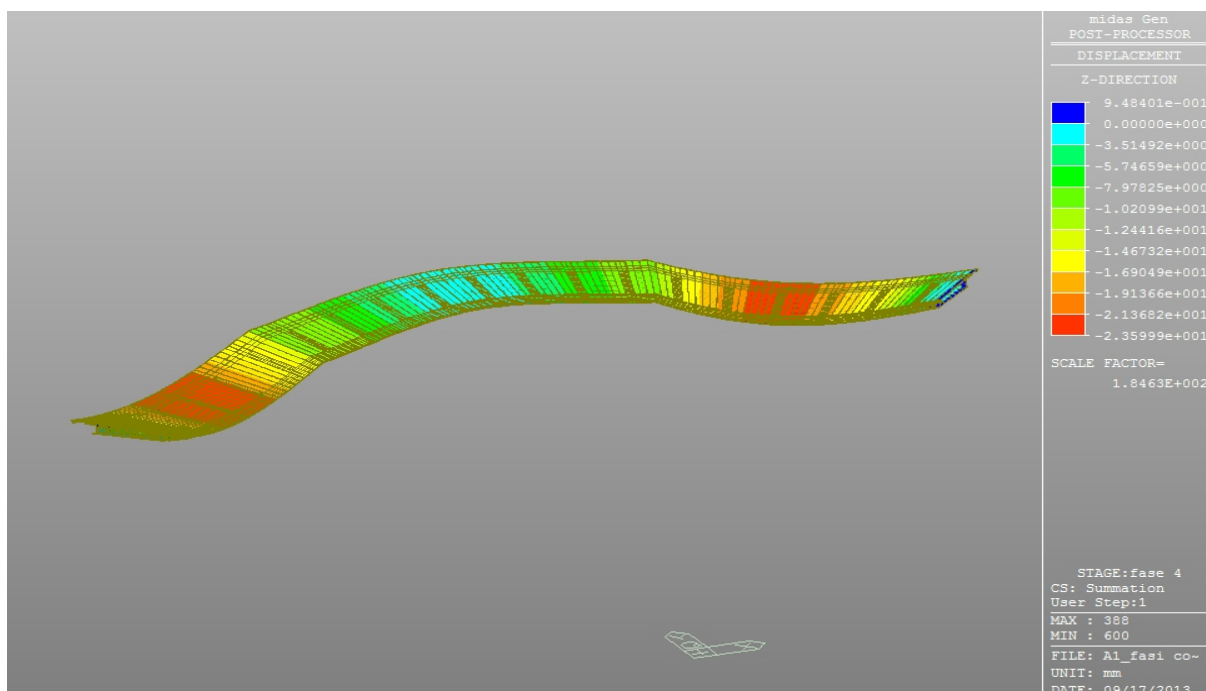
$$S_z = 58.8\text{mm} < L/700 = 44760/700 = 63.9 \text{ mm}$$

Per compensare le deformazioni da peso proprio in Fase 1 per il varo in opera dei conci, si adotteranno contromonte di costruzione in campata pari rispettivamente a 20mm per i conci 1 e 3 e pari a 5mm per il concio 2.

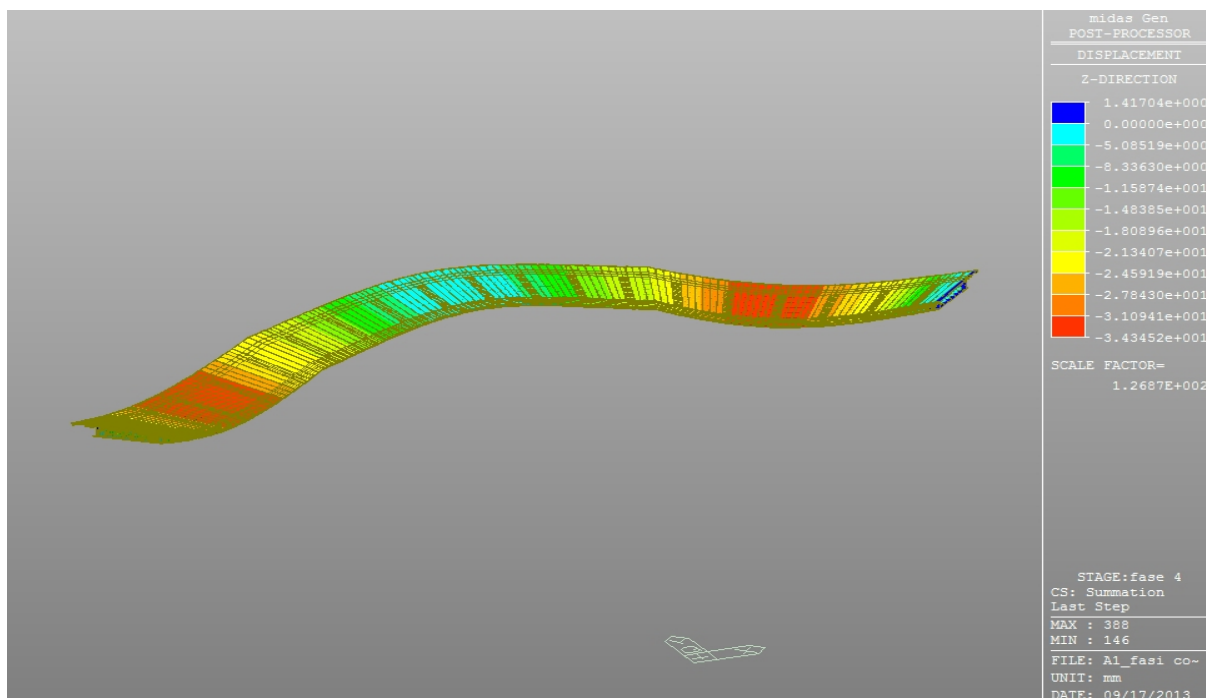
Per compensare le deformazioni dovute ai carichi permanenti a lungo termine in Fase 4 si adotteranno contromonte di costruzione pari a 20mm da predisporre in corrispondenza dei puntelli provvisori intermedi di appoggio dei singoli conci.

10.2 Reazioni agli appoggi

Nella tabella seguente si riportano le reazioni massime e minime agli appoggi per l'involuppo delle combinazioni di carico agli Stati Limite Ultimi. Si precisa che tali reazioni non sono comprensive delle forze di attrito ai vincoli.



Figura 75 – Numerazione vincoli ed assi

	No.	Load	Node	Axial (kN)	Shear-y (kN)	Shear-z (kN)
	1	INVSLU(max)	400	-1210.6	0	1305.58
			394	-1210.6	0	1305.58
	2	INVSLU(max)	395	-942.8	-881.86	149.2
			389	-942.8	-881.86	149.2
	3	INVSLU(max)	399	-1376.25	0	0
			393	-1376.25	0	0
	4	INVSLU(max)	397	-208.99	-290.26	0
			391	-208.99	-290.26	0
	5	INVSLU(max)	398	-1390.69	-133.4	0
			392	-1390.69	-133.4	0
	6	INVSLU(max)	396	-181.44	9.98	0
			390	-181.44	9.98	0
	1	INVSLV(max)	400	-1573.16	0	89.54
			394	-1573.16	0	89.54
	2	INVSLV(max)	395	-1452.7	-1790.87	-73.03
			389	-1452.7	-1790.87	-73.03
	3	INVSLV(max)	399	-1567.5	0	0
			393	-1567.5	0	0
	4	INVSLV(max)	397	-422.09	-589.32	0
			391	-422.09	-589.32	0
	5	INVSLV(max)	398	-1581.42	-348.57	0
			392	-1581.42	-348.57	0
	6	INVSLV(max)	396	-394.2	-230.67	0
			390	-394.2	-230.67	0
	1	INVSLU(min)	400	-3137.03	0	-525.11
			394	-3137.03	0	-525.11
	2	INVSLU(min)	395	-2670.08	-2494.75	-321.96
			389	-2670.08	-2494.75	-321.96
	3	INVSLU(min)	399	-2513.97	0	0
			393	-2513.97	0	0
	4	INVSLU(min)	397	-543.01	-977.91	0
			391	-543.01	-977.91	0
	5	INVSLU(min)	398	-2533.92	-566.55	0
			392	-2533.92	-566.55	0
	6	INVSLU(min)	396	-517.45	-471.31	0
			390	-517.45	-471.31	0
	1	INVSLV(min)	400	-1573.16	0	89.54
			394	-1573.16	0	89.54
	2	INVSLV(min)	395	-1452.7	-1790.87	-73.03
			389	-1452.7	-1790.87	-73.03
	3	INVSLV(min)	399	-1567.5	0	0
			393	-1567.5	0	0
	4	INVSLV(min)	397	-422.09	-589.32	0
			391	-422.09	-589.32	0
	5	INVSLV(min)	398	-1581.42	-348.57	0
			392	-1581.42	-348.57	0
	6	INVSLV(min)	396	-394.2	-230.67	0
			390	-394.2	-230.67	0

Tabella 5. Reazioni massime e minime agli appoggi (SLU-SLV)

11. Aspetti geotecnici e fondazioni

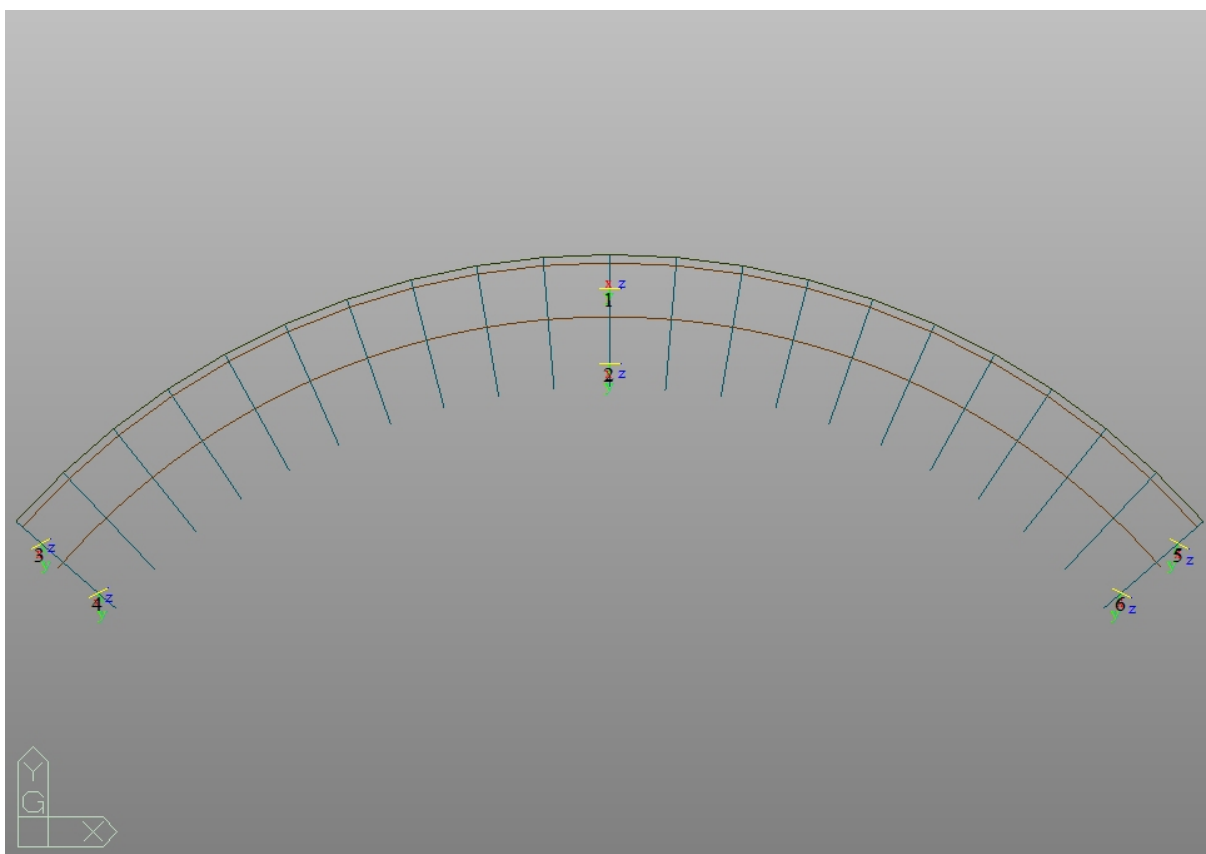
11.1 Premessa

Con riferimento al sottosuolo nell'area di progetto, la caratterizzazione ai fini della valutazione della risposta sismica locale è stata effettuata in fase di progettazione mediante indagini geofisiche in grado di stimare la distribuzione delle onde di taglio nei primi 30 m. In particolare, come ampiamente descritto nella Relazione geologico-geotecnica, sono state effettuate indagini di tipo Tomografiche elettriche, Down-hole e MASW che hanno permesso di classificare il sottosuolo come di categoria B, ossia *“Rocce tenere e depositi di terreni a grana grossa molto addensati o terreni a grana fina molto consistenti con spessori superiori a 30 m, caratterizzati da un graduale miglioramento delle proprietà meccaniche con la profondità e da valori di $V_{s,30}$ compresi tra 360 m/s e 800 m/s (ovvero $N_{SPT,30} > 50$ nei terreni a grana grossa e $c_{u,30} > 250$ kPa nei terreni a grana fina)”*

La tipologia del terreno di fondazione e le caratteristiche della struttura in elevazione, hanno fortemente condizionato la scelta del tipo di fondazione da realizzare. Si è optato per una fondazione di tipo indiretta costituita da plinti in c.a., poggianti su pali trivellati $\phi 800$ in c.a..

11.2 Caratterizzazione meccanica dei terreni

La caratterizzazione meccanica dei terreni di fondazione fa riferimento alle dettagliate indagini geognostiche effettuate ed elaborate nelle relazioni geologiche e geotecniche. Per una completa descrizione dell'area si rimanda alla Relazione geologico-geotecnica. In sintesi, l'area è impostata sui depositi quaternari della Dora Riparia che scorre nelle immediate vicinanze. Dalle analisi delle stratigrafie dei sondaggi realizzati si evince che si tratta di sedimenti prevalentemente medio-grossolani costituiti da ghiaie e ghiaie ciottolose in matrice sabbiosa o sabbioso-limosa, passanti localmente a sabbie limose con ghiaia e locali ciottoli. Il basamento roccioso, che non viene raggiunto dalle opere in progetto, è costituito dai litotipi appartenenti all'Unità tettometamorfica del Dora-Maira.

In base alle unità litostratigrafiche individuate ed in base ai risultati delle prove in foro e di laboratorio realizzate, è stato possibile riconoscere nell'area di studio quattro unità geotecniche fondamentali:

- *unità geotecnica UG1*: comprende l'orizzonte di potenza variabile di terreno di riporto di tipo prevalentemente ghiaioso-ciottoloso con subordinata sabbia limosa;
- *unità geotecnica UG2*: corrispondente ai depositi prevalentemente costituiti da sabbia e sabbia limosa con ghiaia e rari ciottoli presenti localmente nei primi metri al di sotto dei terreni dell' UG1;
- *unità geotecnica UG3*: è l'unità dominante e comprende i depositi più grossolani rappresentati da ghiaie con ciottoli in matrice sabbiosa o sabbioso-limosa caratterizzati da un grado di addensamento da medio ad alto;
- *unità geotecnica UG4*: è costituita da depositi più fini limoso-sabbiosi con subordinata ghiaia. Tali terreni formano livelli discontinui di potenza ridotta (mediamente metrica) intercalati all'interno dei litotipi dell'unità sopradescritta a partire da circa 15m di profondità.

I parametri geotecnici, in riferimento alla relazione geotecnica, sono:

- peso di volume unitario saturo: $\gamma_{sat} = 21 \frac{KN}{m^3}$
- peso di volume unitario efficace: $\gamma' = 11 \frac{KN}{m^3}$
- coesione: $c = 0 KPa$
- angolo di attrito: $\varphi = 35 \div 39^\circ$

11.3 Criteri di analisi e verifica agli Stati Limite Ultimi

Gli stati limite ultimi delle fondazioni su pali si riferiscono allo sviluppo di meccanismi di collasso determinati dalla mobilitazione della resistenza del terreno e al raggiungimento della resistenza degli elementi strutturali che compongono la fondazione stessa.

Per ogni stato limite ultimo deve essere verificata la condizione:

$$E_d \leq R_d$$

dove E_d rappresenta l'insieme amplificato delle azioni agenti, ed R_d l'insieme delle resistenze, queste ultime corrette in funzione della tipologia del metodo di approccio al calcolo eseguito, della geometria del sistema e delle proprietà meccaniche dei materiali e dei terreni in uso.

Nelle verifiche del complesso terreno – fondazione è stato perseguito l'approccio progettuale di tipo 2, che prevede un'unica combinazione di gruppi di coefficienti (**A1+M1+R3**) da adottare sia nelle verifiche strutturali sia in quelle geotecniche.

In particolare, in funzione del tipo di verifica da eseguire, avremo, per le azioni derivanti da carichi gravitazionali, i seguenti coefficienti parziali:

Carichi	Coefficiente parziale γ_F (o γ_E)	(A1) STR
Permanenti	γ_{G1}	1.0÷1.35
Perm. non strutturali	γ_{G2}	1.0÷1.35
Variabili	$\gamma_{Q,i}$	0.0÷1.5
Variabili da traffico	γ_Q	0.0÷1.35

Tabella 6. Coefficienti parziali per le azioni o per l'effetto delle azioni

Ai fini delle resistenze, in funzione del tipo di verifica da eseguire, il valore di progetto può ricavarsi in base alle indicazioni innanzi riportate.

Parametro	Parametro di riferimento	Coefficiente parziale γ_M	(M1)
Tangente dell'angolo di resistenza al taglio	$\tan \varphi'_K$	$\gamma_{\varphi'}$	1.0
Coesione efficace	c'_K	$\gamma_{c'}$	1.0
Resistenza non drenata	c_{uk}	γ_{cu}	1.0
Peso dell'unità di volume	γ	γ_γ	1.0

Tabella 7. Coefficienti parziali per i parametri geotecnici del terreno

Le verifiche, riportate nel seguito della presente, saranno effettuate nei confronti dei seguenti stati limite:

SLU di tipo geotecnico (GEO)

collasso per carico limite verticale del complesso pali-terreno;
collasso per carico limite orizzontale del complesso pali-terreno.

SLU di tipo strutturale (STR)

raggiungimento della resistenza dei pali;
raggiungimento della resistenza della struttura di collegamento dei pali.

Le verifiche sono condotte per la sola fondazione della pila-antenna centrale. Per le verifiche in fondazione delle pile di estremità si rimanda alle relazioni di calcolo delle rampe adiacenti al ponte strallato.

11.4 Verifiche di resistenza di tipo “GEO”

Di seguito, si riportano alcune immagini relative alle sollecitazioni verticali ed orizzontali sui pali relative agli involuipi SLU e SLV.



Figura 76 – Azioni verticali sui pali (SLU)



Figura 77 – Azioni verticali sui pali (SLV)

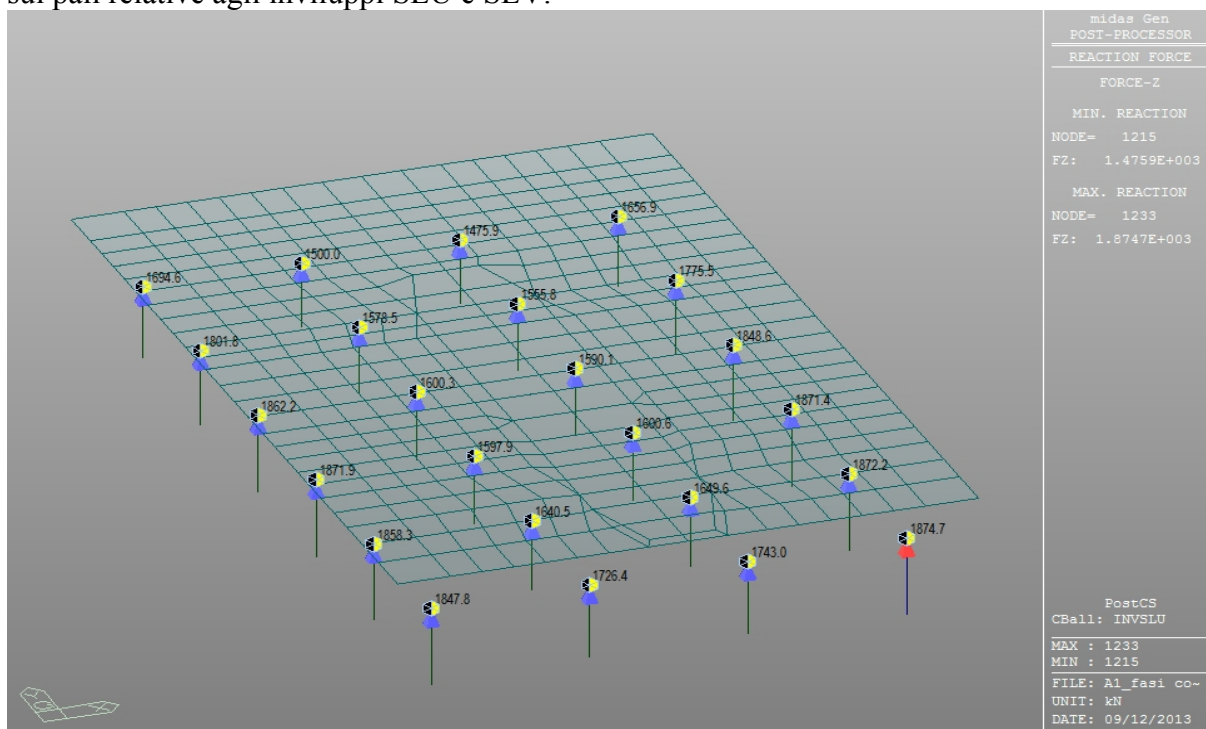

Figura 78 – Azioni orizzontali in direzione x sui pali (SLV)

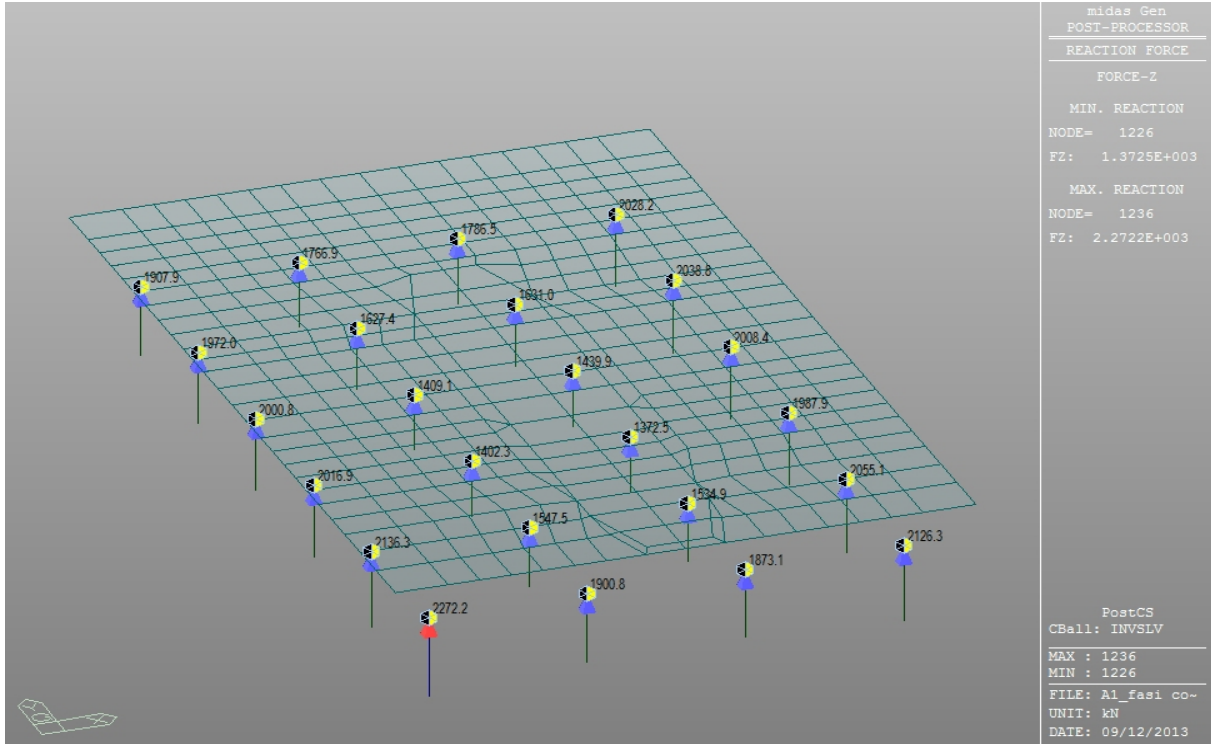

Figura 79 – Azioni orizzontali in direzione y sui pali (SLV)

Di seguito, si riportano le verifiche a carico limite verticale ed orizzontale del complesso palo-terreno.

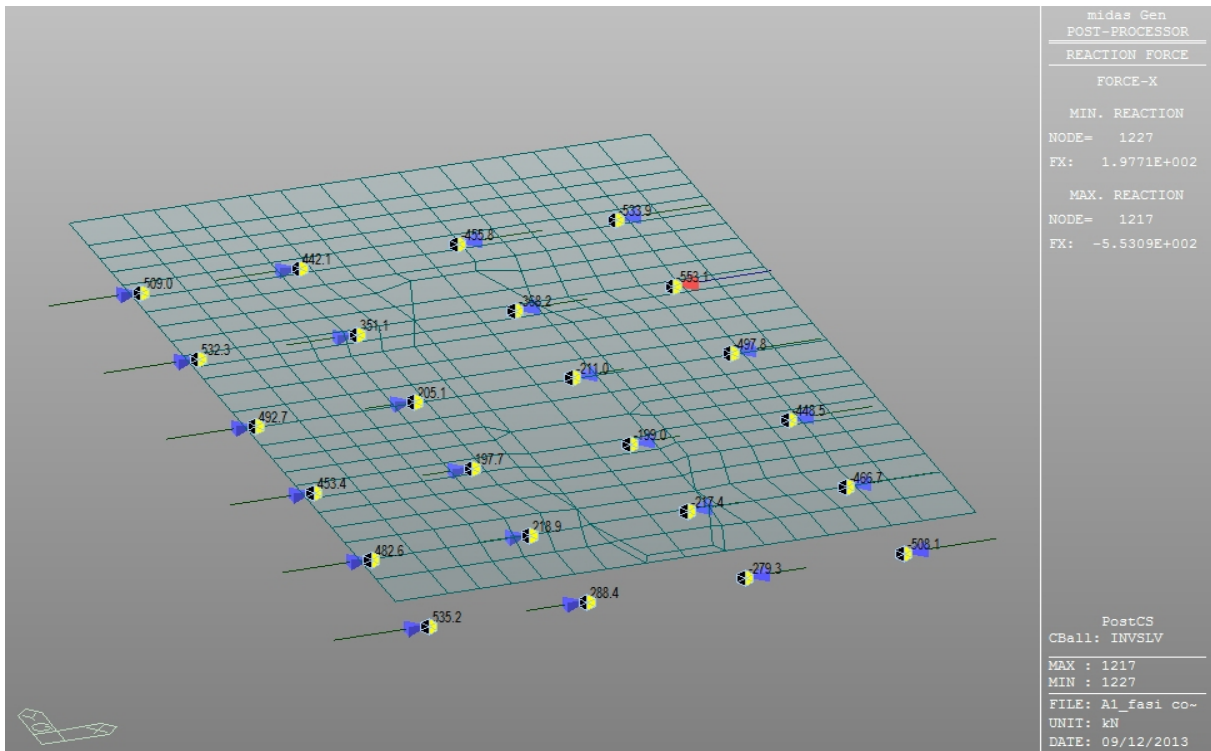
CALCOLO DELLA CAPACITA' PORTANTE DI UN PALO TRIVELLATO DI GRANDE DIAMETRO

CANTIERE:

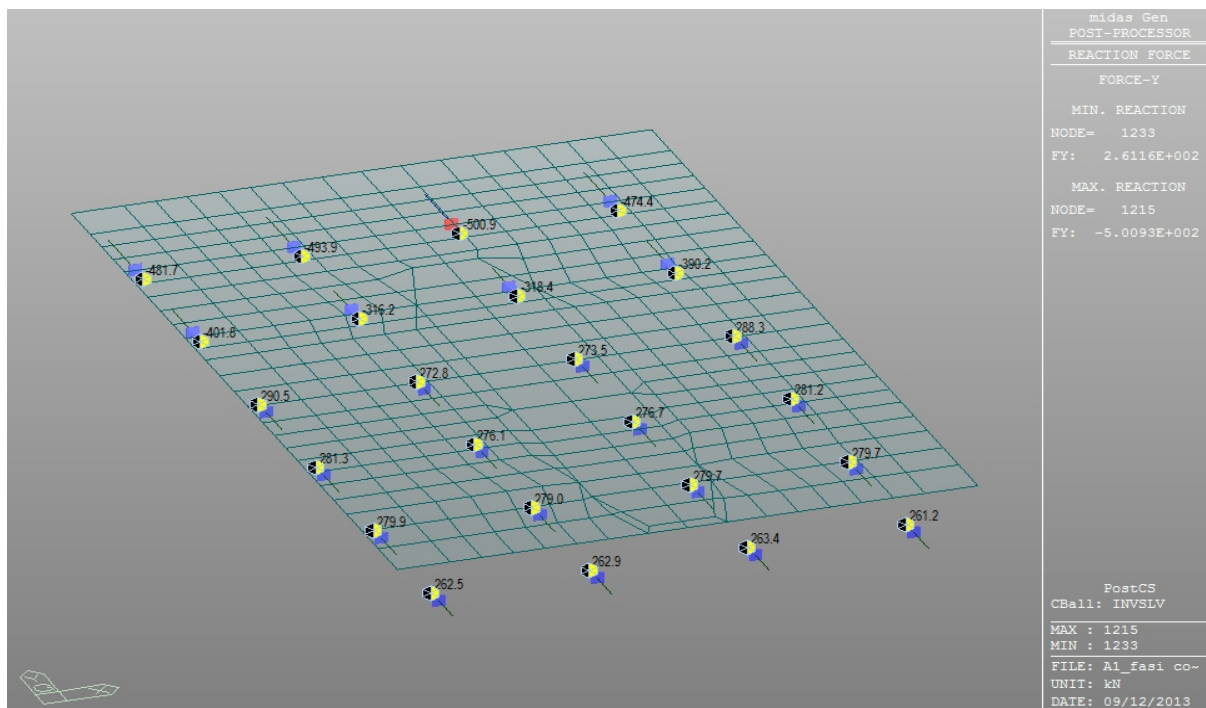
OPERA:

Autoporto Susa-ponte strallato

DATI DI INPUT:

Diametro del Palo (D): 0.80 (m) Area del Palo (Ap): 0.503 (m²)
 Quota testa Palo dal p.c. (z_p): 2.00 (m) Quota falda dal p.c. (z_w): 2.00 (m)
 Carico Assiale Permanente (G): 2273 (kN) Carico Assiale variabile (Q): (kN)
 Numero di strati 1 Lpalo = 23.00 (m)

coefficienti parziali		azioni		resistenza laterale e di base		
Metodo di calcolo		permanent	variabili	γ _b	γ _s	γ _{s traz}
SU	A1+M1+R1	1.30	1.50	1.00	1.00	1.00
	A2+M1+R2	1.00	1.30	1.70	1.45	1.60
	A1+M1+R3	1.30	1.50	1.35	1.15	1.25
	SISMA	1.00	1.00	1.35	1.15	1.25
DM88	1.00	1.00	1.00	1.00	1.00	
definiti dal progettista	1.00	1.00	1.35	1.15	1.25	

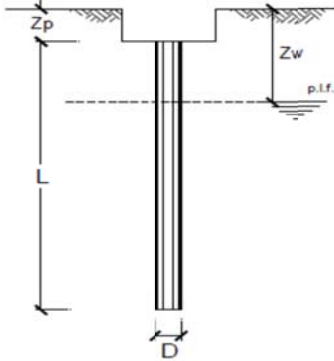

n	1	2	3	4	5	6	7	≥10	7^A	prog.
γ _b	1.70	1.35	1.60	1.55	1.50	1.45	1.40	1.40	1.00	1.00
γ _s	1.70	1.55	1.48	1.42	1.34	1.28	1.21	1.21	1.00	1.00

PARAMETRI MEDI

Strato	Spess (m)	Tipo di terreno	Parametri del terreno			
			γ (kN/m ³)	c' med (kPa)	φ' med (°)	c _u med (kPa)
1	23.00		21.00		37.0	

Coefficienti di Calcolo			
k	μ	α	α
(-)	(-)	(-)	(-)
0.40	0.75		

(n.b.: lo spessore degli strati è computato dalla quota di intradosso del plinto)

PARAMETRI MINIMI (solo per SLU)

Strato	Spess (m)	Tipo di terreno	Parametri del terreno			
			γ (kN/m ³)	c' min (kPa)	φ' min (°)	c _u min (kPa)
1	23.00		21.00		35.0	

Coefficienti di Calcolo			
k	μ	α	α
(-)	(-)	(-)	(-)
0.43	0.70		

RISULTATI

Strato	Spess (m)	Tipo di terreno	media					minime (solo SLU)				
			Qs1 (kN)	Nq (-)	Nc (-)	qb (kPa)	Qbm (kN)	Qs1 (kN)	Nq (-)	Nc (-)	qb (kPa)	Qbm (kN)
1	23.00		2922.6	36.23	0.00	10687.9	5372.3	2908.3	27.42	0.00	8088.4	4065.7

CARICO ASSIALE AGENTE

$N_d = N_G \cdot \gamma_G + N_Q \cdot \gamma_Q$

$N_d = 2273.0 \text{ (kN)}$

CAPACITA' PORTANTE MEDIA

base $R_{d,cal med} = 5372.3 \text{ (kN)}$

laterale $R_{s,cal med} = 2922.6 \text{ (kN)}$

totale $R_{c,cal med} = 8294.9 \text{ (kN)}$

CAPACITA' PORTANTE MINIMA

base $R_{d,cal min} = 4065.7 \text{ (kN)}$

laterale $R_{s,cal min} = 2908.3 \text{ (kN)}$

totale $R_{c,cal min} = 6974.0 \text{ (kN)}$

CAPACITA' PORTANTE CARATTERISTICA

$R_{d,k} = \text{Min}(R_{d,cal med}/\gamma_{s1}; R_{d,cal min}/\gamma_{s4}) = 2863.2 \text{ (kN)}$

$R_{s,k} = \text{Min}(R_{s,cal med}/\gamma_{s3}; R_{s,cal min}/\gamma_{s4}) = 1885.5 \text{ (kN)}$

$R_{c,k} = R_{d,k} + R_{s,k} = 4748.7 \text{ (kN)}$

CAPACITA' PORTANTE DI PROGETTO

$R_{c,d} = R_{d,k}/\gamma_b + R_{s,k}/\gamma_s$

$R_{c,d} = 3760.5 \text{ (kN)}$

$F_s = R_{c,d} / N_d$

$F_s = 1.65$

**CARICO LIMITE ORIZZONTALE DI UN PALO IN TERRENI INCOERENTI
PALI CON ROTAZIONE IN TESTA IMPEDITA**

OPERA: Autoporto Susa-ponte strallato

TEORIA DI BASE:

(Broms, 1964)

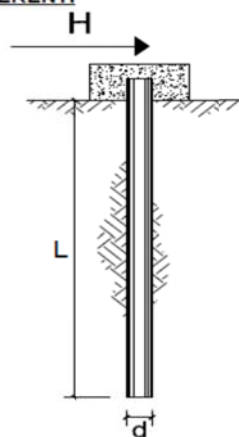

coefficienti parziali			A		M	R
Metodo di calcolo			permanenti γ_G	variabili γ_Q	γ_ψ	γ_T
S.U.	A1+M1+R1	○	1.30	1.50	1.00	1.00
	A2+M1+R2	○	1.00	1.30	1.00	1.60
	A1+M1+R3	○	1.30	1.50	1.00	1.30
	SISMA	⊙	1.00	1.00	1.00	1.30
DM88			○	1.00	1.00	1.00
definiti dal progettista			○	1.30	1.25	1.00

n	1	2	3	4	5	7	≥10	T.A.	prog.
ζ_3	1.70	1.65	1.60	1.55	1.50	1.45	1.40	1.00	1.00
ζ_4	1.70	1.55	1.48	1.42	1.34	1.28	1.21	1.00	1.00

Palo corto:
$$H = 1.5k_p \gamma d^3 \left(\frac{L}{d}\right)^2$$

Palo intermedio:
$$H = \frac{1}{2} k_p \gamma d^3 \left(\frac{L}{d}\right)^2 + \frac{M_y}{L}$$

Palo lungo:
$$H = k_p \gamma d^3 \sqrt[3]{\left(3.676 \frac{M_y}{k_p \gamma d^4}\right)^2}$$

DATI DI INPUT:

Lunghezza del palo	L =	23.00	(m)		
Diametro del palo	d =	0.80	(m)		
Momento di plasticizzazione della sezione	My =	1959.10	(kN m)		
Angolo di attrito del terreno	φ'_{med} =	37.00	(°)	φ'_{min} =	35.00 (°)
Angolo di attrito di calcolo del terreno	$\varphi'_{med,d}$ =	37.00	(°)	$\varphi'_{min,d}$ =	35.00 (°)
Coeff. di spinta passiva ($k_p = (1+\sin\varphi')/(1-\sin\varphi')$)	$k_{p,med}$ =	4.02	(-)	$k_{p,min}$ =	3.69 (-)
Peso di unità di volume (con falda $\gamma = \gamma'$)	γ =	11.00	(kN/m ³)		
Carico Assiale Permanente (G):	G =	565.7	(kN)		
Carico Assiale variabile (Q):	Q =	0	(kN)		

Palo corto:

$H1_{med} = 28090.35$ (kN) $H1_{min} = 25767.74$ (kN)

Palo intermedio:

$H2_{med} = 9448.63$ (kN) $H2_{min} = 8674.42$ (kN)

Palo lungo:

$H3_{med} = 1224.50$ (kN) $H3_{min} = 1189.77$ (kN)

$H_{med} = 1224.50$ (kN) palo lungo $H_{min} = 1189.77$ (kN) palo lungo

$H_k = \text{Min}(H_{med}/\zeta_3 ; R_{min}/\zeta_4) = 790.00$ (kN)

$H_d = H_k/\gamma_T = 607.69$ (kN)

$F_d = G \cdot \gamma_G + Q \cdot \gamma_Q = 565.70$ (kN)

$FS = H_d / F_d = 1.07$

11.5 Verifiche di resistenza di tipo “STR”

Di seguito, si riportano alcune immagini relative alle sollecitazioni agenti sulla zattera di fondazione relative agli involuپی SLU e SLV.



Figura 80 – Momenti flettenti in direzione x (SLU)



Figura 81 – Momenti flettenti in direzione y (SLU)

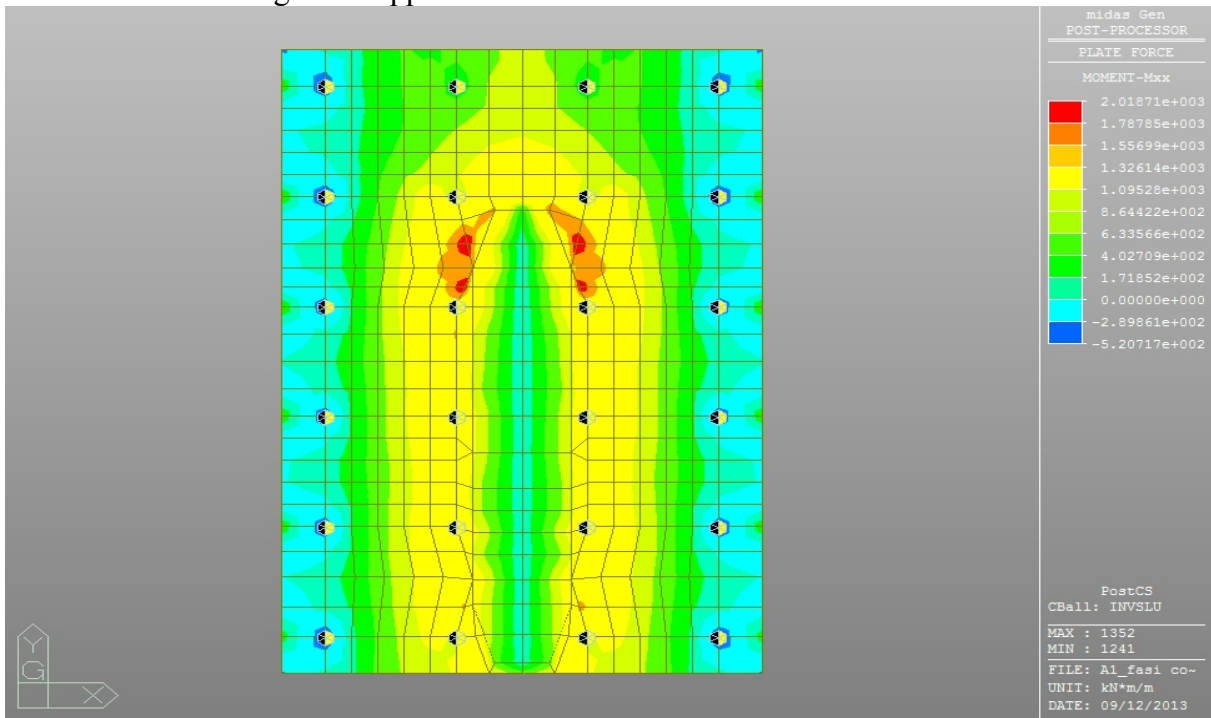

Figura 82 – Momenti flettenti in direzione x (SLV)

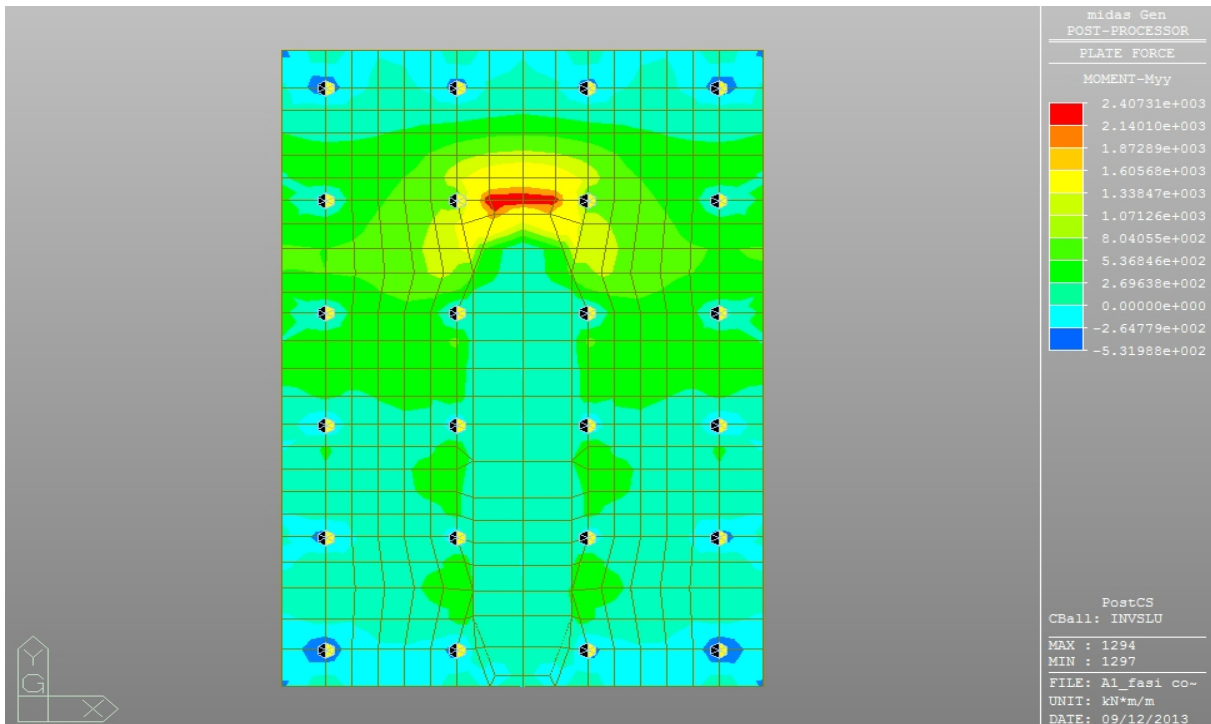

Figura 83 – Momenti flettenti in direzione y (SLV)

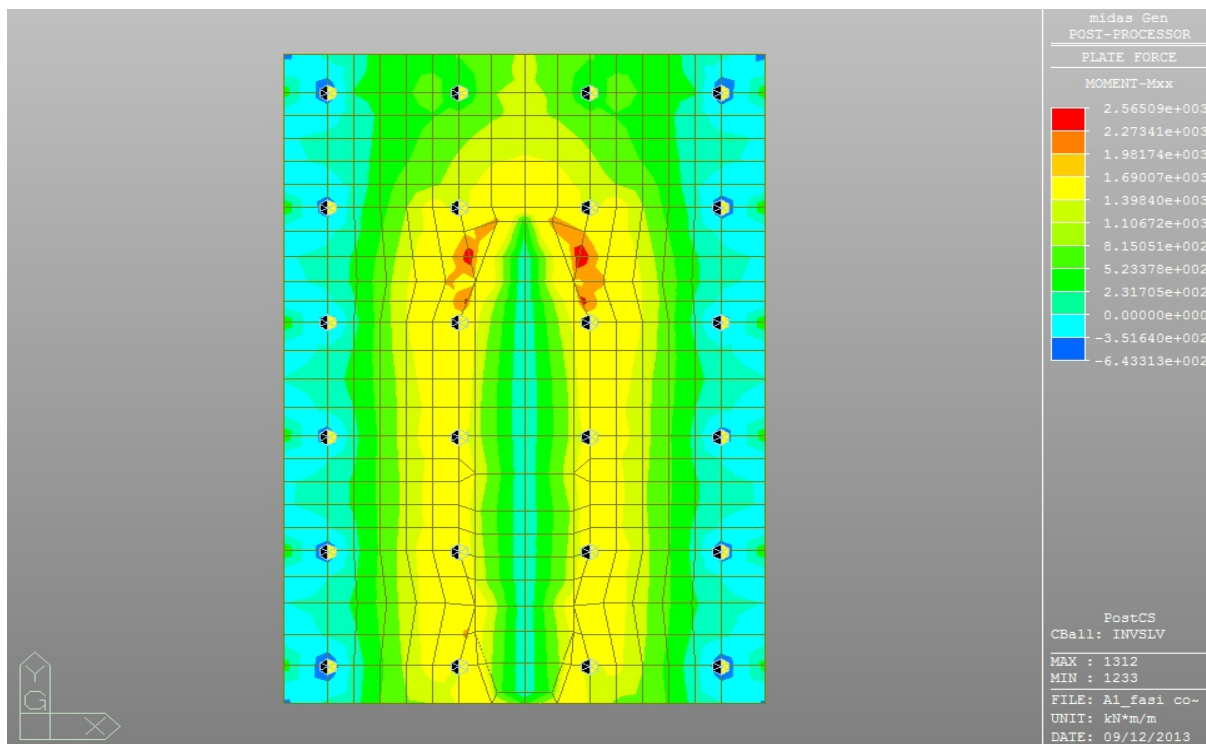

Figura 84 – Tagli in direzione x (SLU)

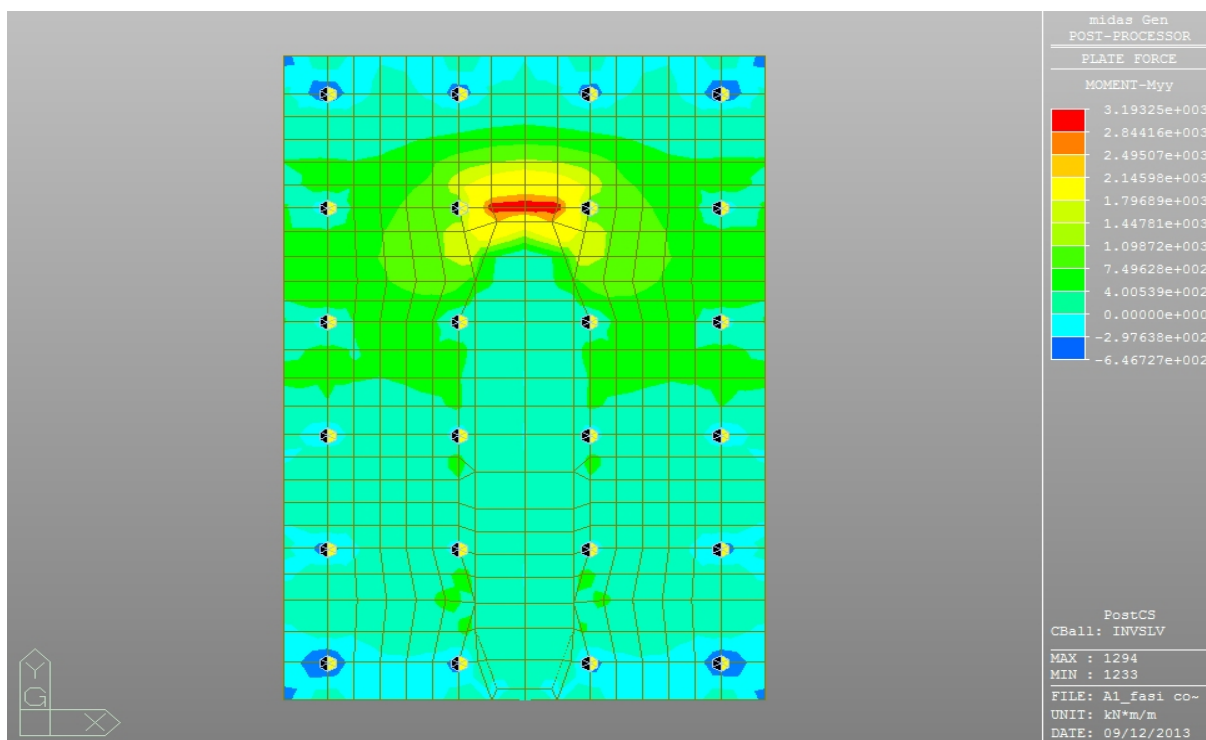

Figura 85 – Tagli in direzione y (SLU)

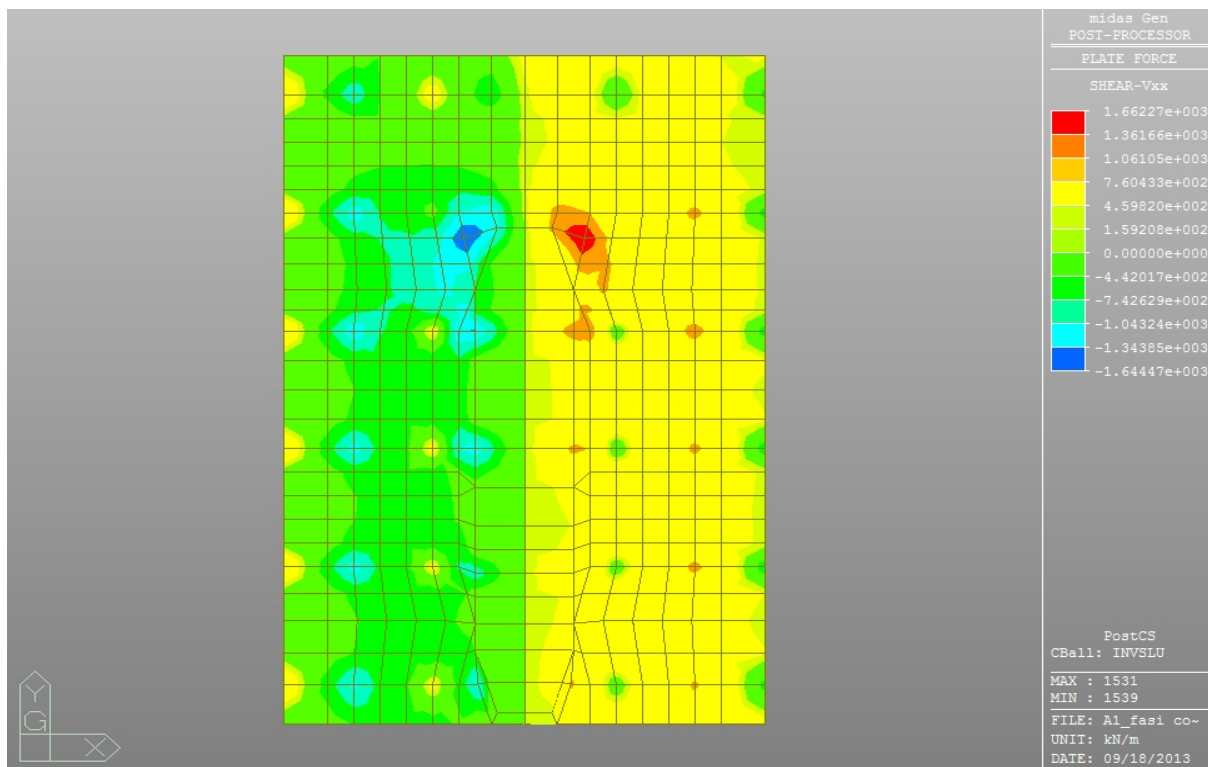

Figura 86 – Tagli in direzione x (SLV)

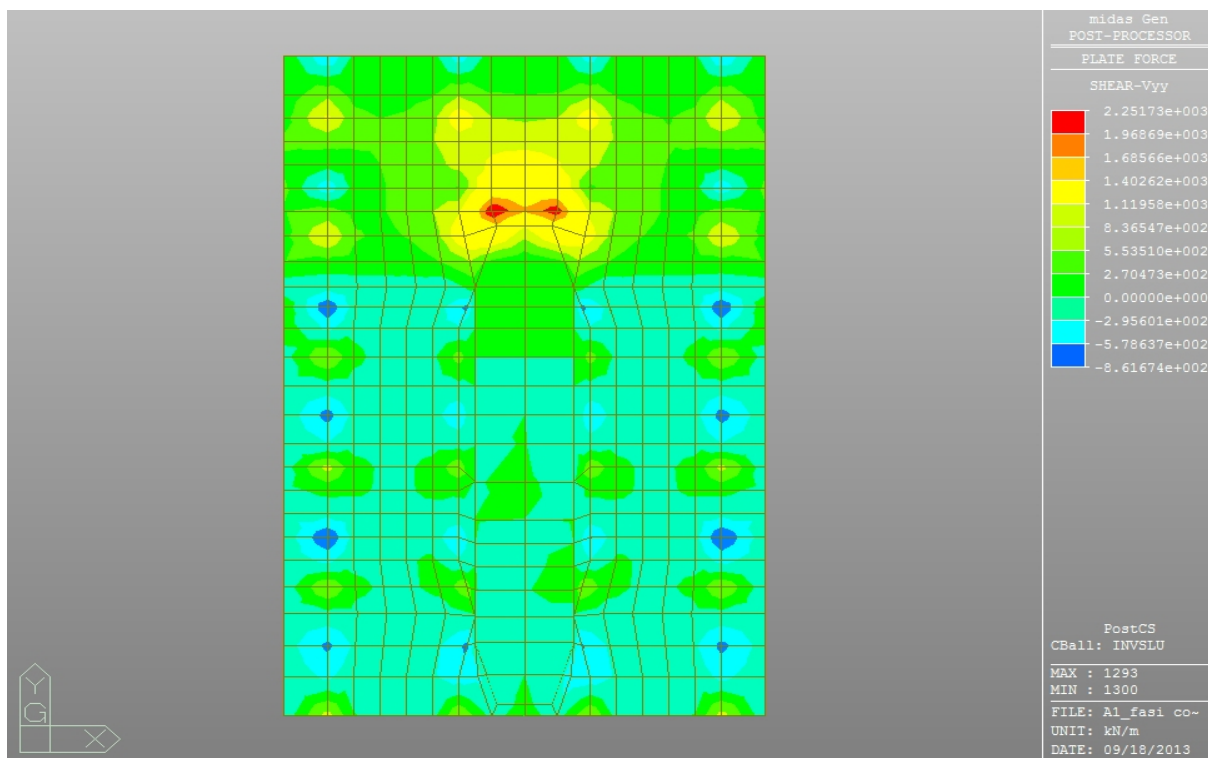

Figura 87 – Tagli in direzione y (SLV)

Di seguito, si riportano le verifiche di resistenza a pressoflessione e taglio dei pali in c.a. e della zattera di fondazione. Il palo $\phi 800$ è armato con $28\phi 24$, mentre la zattera di fondazione ($h=2.00\text{m}$) è armata con una rete sup. ed inf. $\phi 24/20$ e con infittimenti inferiori in entrambe le direzioni in corrispondenza dell'antenna pari a $\phi 26/20$.

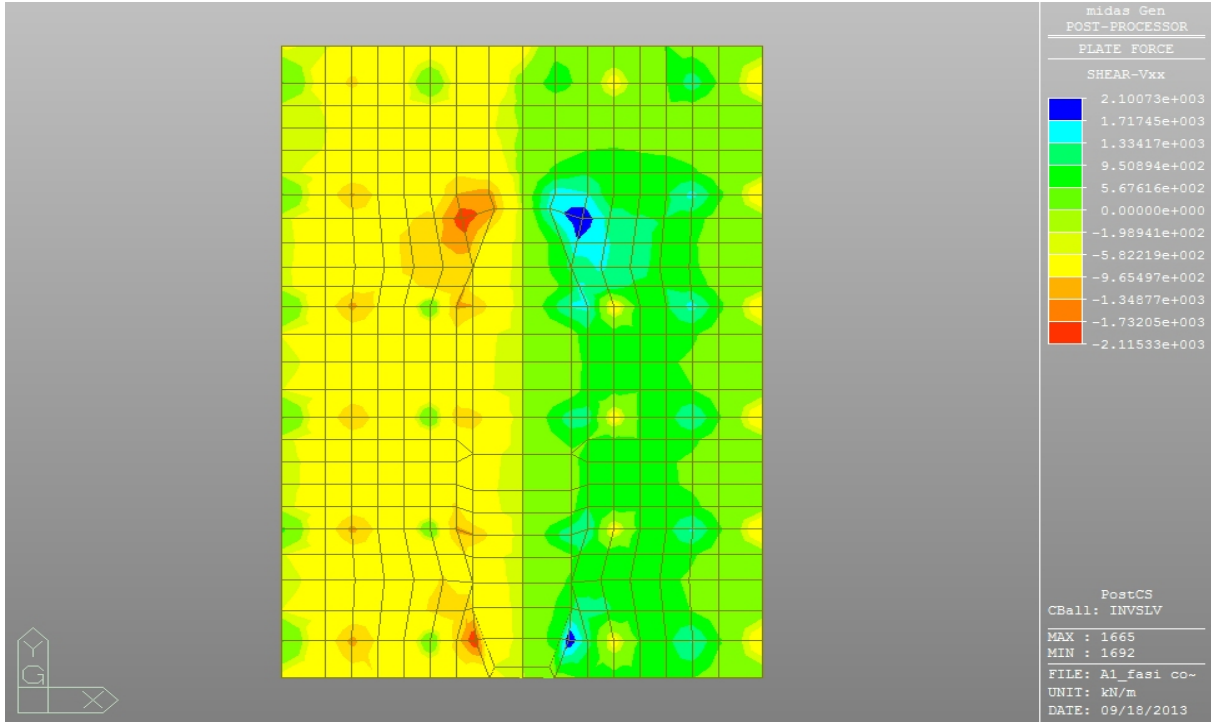
Verifica a pressoflessione del palo $\phi 800$

Per la combinazione di carico più sfavorevole (SLV3y) i momenti flettenti nel palo sono pari a:

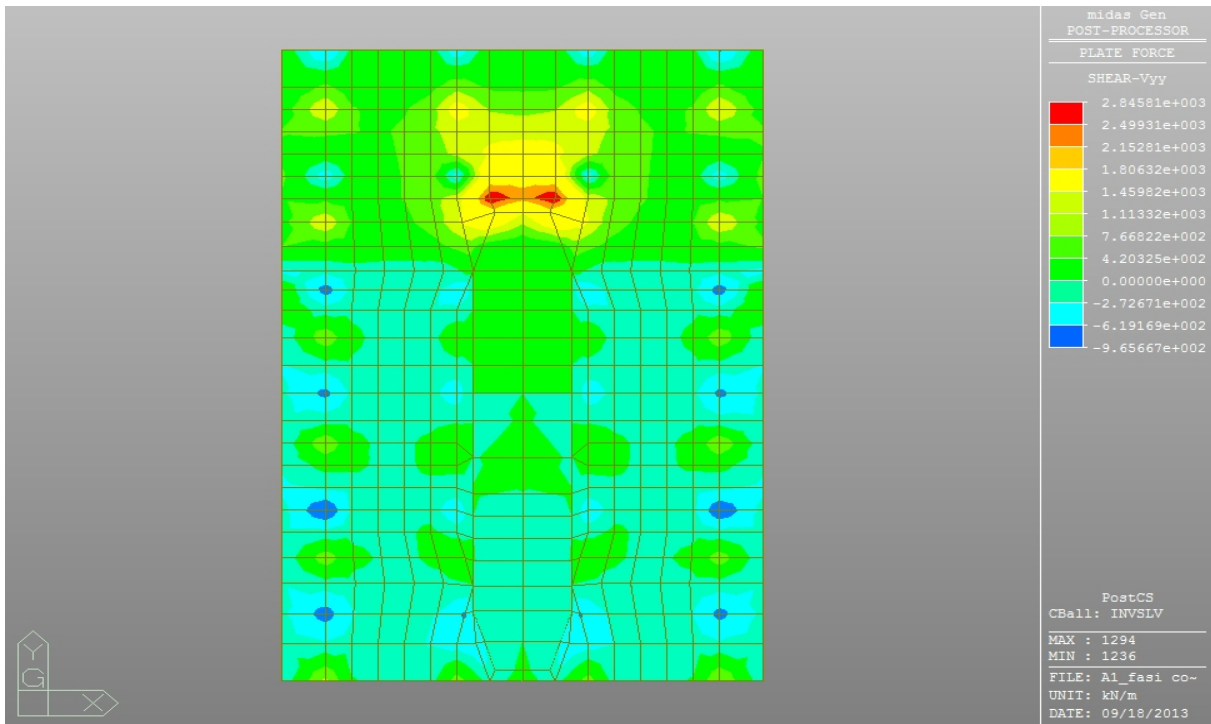
PALI IMPEDITI DI RUOTARE IN TESTA SOGGETTI A FORZE ORIZZONTALI

OPERA: Autoporto Susa-ponte strallato

DATI DI INPUT:

Diametro del palo (D):	0.8	(m)
Lunghezza del palo (L)	23	(m)
Coefficiente di reazione laterale (k_h):	10	(N/cm ³)
Forza orizzontale agente (T):	565.7	(kN)
fck del calcestruzzo:	28.0	(MPa)
fcm del calcestruzzo:	36.0	(MPa)
Ecls ($E = 22000(fcm/10)^{0.3}$):	32308	(MPa)
J ($J = \pi \cdot D^4/64$):	2010619	(cm ⁴)
λ (lunghezza elastica $\lambda = (4 \cdot EJ/k_h \cdot D)^{1/4}$):	424.53	(cm)

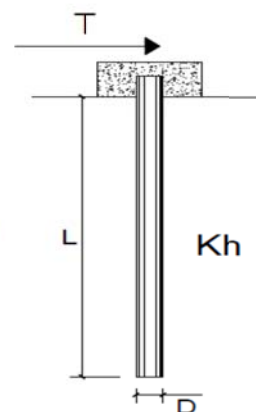

z	y(z)	p(z)	$\alpha(z)$	M(z)	T(z)
Prof.	Spost.	Press. Lat.	Rotaz.	Mom. Flett.	Taglio
(m)	(cm)	(N/cm ²)	(rad)	(kNm)	(kN)
0.00	1.666	16.66	0.00000	1203.769	-565.700
0.46	1.648	16.48	-0.00076	954.619	-504.630
0.92	1.598	15.98	-0.00136	736.314	-444.826
1.38	1.525	15.25	-0.00181	545.029	-387.301
1.84	1.434	14.34	-0.00214	379.529	-332.824
2.30	1.330	13.30	-0.00235	238.278	-281.948
2.76	1.218	12.18	-0.00248	119.527	-235.043
3.22	1.103	11.03	-0.00253	21.395	-192.325
3.68	0.987	9.87	-0.00251	-58.067	-153.878
4.14	0.872	8.72	-0.00245	-120.824	-119.679
4.60	0.762	7.62	-0.00235	-168.808	-89.622
5.06	0.657	6.57	-0.00221	-203.885	-63.533
5.52	0.559	5.59	-0.00206	-227.832	-41.188
5.98	0.468	4.68	-0.00189	-242.313	-22.329
6.44	0.385	3.85	-0.00172	-248.866	-6.674
6.90	0.310	3.10	-0.00154	-248.899	6.071
7.36	0.243	2.43	-0.00137	-243.681	16.206
7.82	0.184	1.84	-0.00120	-234.345	24.024
8.28	0.132	1.32	-0.00104	-221.890	29.812
8.74	0.088	0.88	-0.00088	-207.187	33.845
9.20	0.051	0.51	-0.00074	-190.983	36.379
9.66	0.020	0.20	-0.00061	-173.911	37.653
10.12	-0.006	-0.06	-0.00050	-156.502	37.885
10.58	-0.026	-0.26	-0.00039	-139.187	37.273
11.04	-0.042	-0.42	-0.00030	-122.313	35.996
11.50	-0.054	-0.54	-0.00022	-106.149	34.208
11.96	-0.063	-0.63	-0.00015	-90.898	32.049
12.42	-0.068	-0.68	-0.00009	-76.703	29.634

Pertanto, la verifica:

Combinazione di Carico 2: SLV3y

Combinazione di Carico: 2

- N: -178700.0 [kg]
- Mx: 120100.0 [kgm]
- My: 0.0 [kgm]

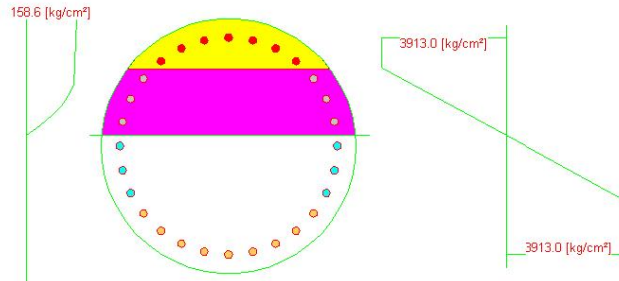

Azioni Resistenti:

- N: -235874.3 [kg]
- Mx: 158525.5 [kgm]
- My: -0.0 [kgm]
- Moltiplicatore dei carichi 0.757607

Verifica a taglio del palo $\phi 800$

Verifiche a taglio - D.M. 14-01-2008

Materiali

Calcestruzzo	
Rck [Mpa]	35
fck [Mpa]	29.1
fcid [Mpa]	16.5

Acciaio

fyk [Mpa]	450
fyd [Mpa]	391.3

k	1.60
v _{min}	0.38
ρ_t	0.0072
σ_{cp}	3.2923

ν	0.5
$(\sigma_{cp})^*$	5.698341837
α_c	1.25
ω_{sw}	0.064
cotg θ	2.961
cotg θ^*	2.500

Geometria sezione

b [mm]	560
h [mm]	560
c [mm]	0
d [mm]	560

Armatura longitudinale

n° barre	5
diámetro	24
Area [mm ²]	2260.8

Armatura trasversale

Staffe Φ	12
n° bracci	2
A _{sw} [mm ²]	226.08
s [mm]	150

Sollecitazioni di calcolo

N _{Ed} [kN]	1787	Comb.
V _{Ed} [kN]	565.7	SLV3y

VERIFICA

Sezione non armata a taglio

V _{Rd} [kN]	320.59
	Armare!!!

Sezione armata a taglio

Crisi armatura a taglio

V _{Rsd} [kN]	743.12
V _{Rcd} [kN]	1001.32

V _{Rd} [kN]	743.12
	Verificato

Verifica a flessione del plinto di fondazione

Combinazione di Carico: SLV3y

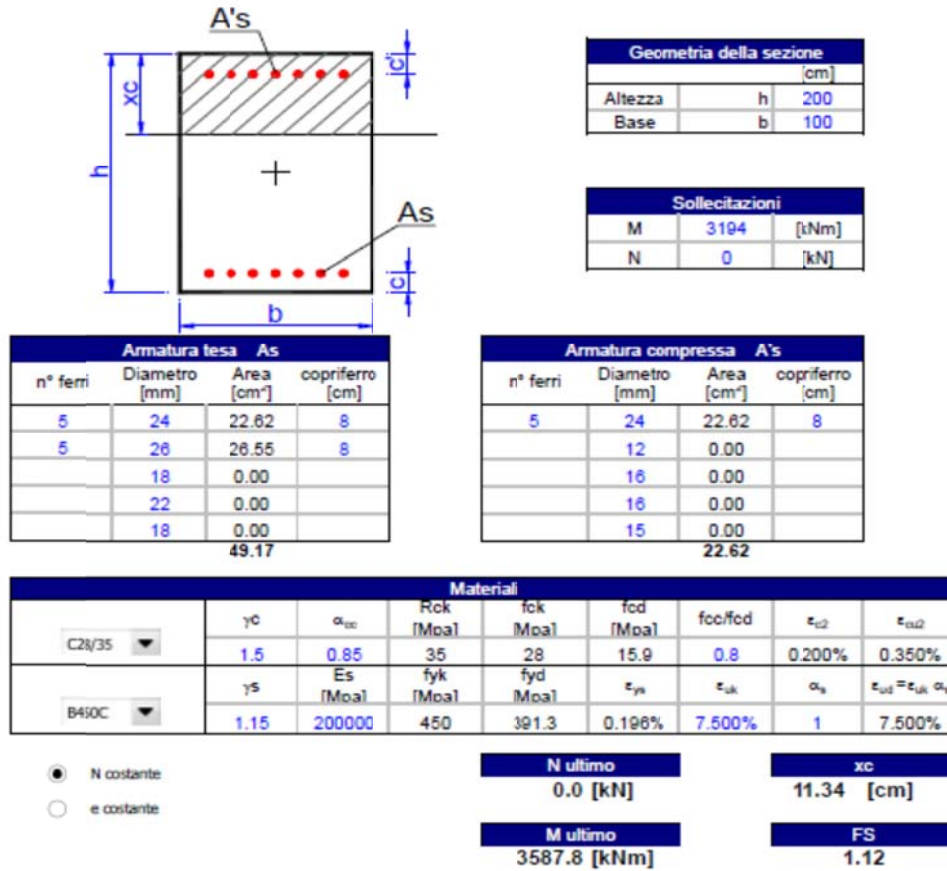

Verifica a taglio del plinto di fondazione

Combinazione di Carico: SLV3y

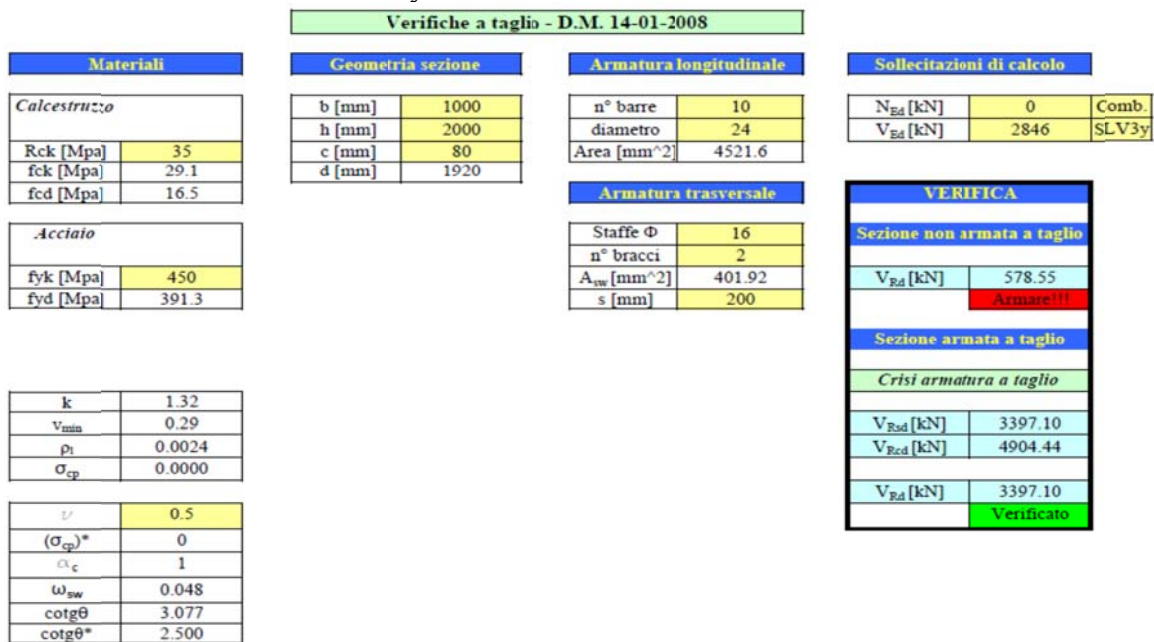

12. Conclusioni

Il progetto è stato redatto in conformità dell'art.17 della Legge 2.2.74 n°64 e dei decreti ministeriali emanati ai sensi degli art.1 e 3 della medesima legge, ed in particolare delle nuove "Norme tecniche per le costruzioni" di cui al D.M. 14 gennaio 2008.

Al fine di migliorare la comprensione delle verifiche svolte, si riportano di seguito alcune tabelle riassuntive delle verifiche più significative degli elementi strutturali.

Strutture in acciaio

Trave cassone				Sollecitazioni						Tensioni massime			Tensioni limite	
sezione di verifica	Elem n.	Ccmb	Part	Axial-x (kN)	Shear-y (kN)	Shear-z (kN)	Torsion (kN*m)	Moment-y (kN*m)	Moment-z (kN*m)	Axial-x (N/mm ²)	Shear-y (N/mm ²)	Shear-z (N/mm ²)	σ _{eff} (N/mm ²)	< f _{yd} (N/mm ²)
campata	1030	SLU-1	J[146]	797.48	640.46	-430.37	3094.49	29094.53	-13098.18	131.3	2.4	6.4	130.9	338.0
appoggio centrale	1080	SLU-4	J[44]	-3269.98	-1418.33	3829.71	-6323.03	-26340.63	14956.62	-127.0	5.8	26.6	136.1	338.0
campata-foro ispezione	1029	SLU-1	J[145]	782.96	642.93	-656.84	3192.33	28733.2	-12737.37	143.8	4.7	7.5	166.7	338.0

Piastra ortotropa superiore			Tensioni massime	Tensioni limite
sezione di verifica	Elem n.	Comb	σ _{eff} (N/mm ²)	< f _{yd} (N/mm ²)
Piastra sp.30mm	7465	SLU-1	305.8	338.0
Irrigid. long. sp.8mm	2139	SLU-1	206.9	338.0
Traverse sp.16mm	7399	SLU-1	273.8	338.0

Traversi				Sollecitazioni			Tensioni massime			Tensioni limite
sezione di verifica	Elem n.	Comb	Part	Axial-x (kN)	Shear-z (kN)	Moment-y (kN*m)	Axial-x (N/mm ²)	Shear-z (N/mm ²)	σ _{eff} (N/mm ²)	< f _{yd} (N/mm ²)
Traverso appoggio centrale	539	SLU-38	I[186]	-163.2	1098	758.9	-88.0	94.4	185.7	338.0
Traverso intermedio	246	SLU-53	I[358]	573.5	803	1404.4	68.3	36.4	93.0	338.0

Stralli				Sollecitazioni	Resistenza di progetto
sezione di verifica	Elem n.	Comb	Part	Axial-x (kN)	< R _{pyd} (kN)
Strallo n.31 trefoli	6	SLU-53	J[516]	1268	6751

Strutture in c.a.

Elemento	Combinazione	b [m]	h [m]	e=c' [m]	As / Ab	A's / Ah	Ast	N _{ed} [kN]	M _{x,ed} [kNm]	M _{y,ed} [kNm]	V _{x,ed} [kN]	V _{y,ed} [kN]	N _{Rd} [kN]	M _{x,Rd} [kNm]	M _{y,Rd} [kNm]	V _{x,Rd} [kN]	V _{y,Rd} [kN]
Pila A2 - Sezione di base	SLV6x	1.8	9.86	0.06	68φ26	φ20/15	/	-11796.3	5.8	40369.5	/	/	-15273.1	7.2	52268.1	/	/
	SLV3x	9.86	1.8	0.06	/	/	8φ12/20	/	/	/	5638.0	/	/	/	/	6807.0	/
	SLV7y	1.8	9.86	0.06	/	/	2φ12/20	/	/	/	/	4553.0	/	/	/	/	9723.0
Antenna A2 - Sezione di base	SLV6y	3.5	1.3	0.06	φ24/10	φ24/10	/	-933.3	547.9	17396.6	/	/	-1210.3	710.6	22560.6	/	/
Antenna A2 - Sezione a q.ta 425.76m	SLU-53	0.76	2.49	0.06	/	/	2φ12/20	/	/	/	949.0	/	/	/	/	2418.0	/
Antenna A2 - Sezione a q.ta 432.29m	SLU-53	2.00	0.49	0.06	/	/	4φ12/20	/	/	/	/	720.0	/	/	/	/	855.9
Platea pila A2 - Sezione filo pila	SLV3y	1.00	2.00	0.08	φ26/20 + φ24/20	φ24/20	/	/	3194.0	/	/	2846.0	/	/	3587.0	/	2846.0
Pali trivellati φ800	SLV3y	0.8	/	0.08	28φ24	/	φ12/15	-1787.0	1201.0	/	566.0	/	-2358.7	1583.3	/	/	3357.0

Le analisi condotte confermano che tutte le verifiche prescritte dalla normativa vigente risultano soddisfatte. Le strutture soddisfano, pertanto, i requisiti di sicurezza prescritti dalle vigenti Leggi.

INPUT DEL MODELLO DI CALCOLO

*** PROJECT INFORMATION

Project Name :
Date : 2013/9/12

*** CONTROL DATA

Panel Zone Effect : Do not Calculate
Unit System : KN, M
Definition of Frame
- X Direction of Frame : Unbraced I Sway
- Y Direction of Frame : Unbraced I Sway
- Design Type : 3-D
Design Code
- Steel : Eurocode3:05
- Concrete : Eurocode2:04
- SRC : SSR79

*** LOAD CASE DATA

NO	NAME	TYPE	SELF WEIGHT FACTOR			DESCRIPTION
			X	Y	Z	
2	G1	USER	0.000	0.000	-1.000	
3	G2	USER	0.000	0.000	0.000	
7	q3	USER	0.000	0.000	0.000	frenamento
8	q4-1	USER	0.000	0.000	0.000	azione centrifuga
11	q4-2	USER	0.000	0.000	0.000	azione centrifuga
12	q4-3	USER	0.000	0.000	0.000	azione centrifuga
1	q5x_pc	USER	0.000	0.000	0.000	vento x
10	q5y_pc	USER	0.000	0.000	0.000	vento y
20	q5x_ps	W	0.000	0.000	0.000	vento ponte scarico x
19	q5y_ps	W	0.000	0.000	0.000	vento ponte scarico y
16	q7	USER	0.000	0.000	0.000	resistenze passive dei vincoli
14	T	USER	0.000	0.000	0.000	variazione termica uniforme
15	DT	USER	0.000	0.000	0.000	variazione termica a farfalla
17	SLXx-Ecc.	USER	0.000	0.000	0.000	eccentricità accidentale 3% sisma ~
18	SLXy-Ecc.	USER	0.000	0.000	0.000	eccentricità accidentale 3% sisma ~
21	P	PS	0.000	0.000	0.000	pretensione cavi
13	N	S	0.000	0.000	0.000	neve
22	G2t	USER	0.000	0.000	0.000	peso terreno

*** MATERIAL PROPERTY DATA

NO	NAME	TYPE	MODULUS OF		THERMAL	POISSON	WEIGHT
			ELASTICITY	SHEAR			
			MODULUS	MODULUS	COEFF.	RATIO	DENSITY
2	S355	STEEL	2.1e+008	8.077e+007	6.667e-006	0.3	76.98
3	rigido	USER	1e+015	3.846e+014	0	0.3	0
5	FLC48	USER	1.652e+008	6.354e+007	1.2e-005	0.3	129
7	C32/40	CONC	3.334e+007	1.389e+007	1e-005	0.2	24.52
8	Cavi	USER	1.961e+008	7.543e+007	1.2e-005	0.3	100
11	C35/45	CONC	3.408e+007	1.42e+007	1e-005	0.2	24.52
12	fittizio	USER	1	0.3846	0	0.3	0
13	C28/35	CONC	3.23e+007	1.346e+007	1e-005	0.2	24.52
14	C32/40-antenna	CONC	3.335e+007	1.389e+007	1e-005	0.2	24.52

NO	NAME	TYPE	STRENGTH OF DESIGN MATERIAL			
			STEEL	CONCRETE	MAIN REBAR	SUB REBAR
2	S355	STEEL	3.55e+005	-	-	-
7	C32/40	CONC	-	0	4e+005	4e+005
11	C35/45	CONC	-	0	4e+005	4e+005
13	C28/35	CONC	-	0	4e+005	4e+005
14	C32/40-antenna	CONC	-	0	4e+005	4e+005

*** NODE DATA

NO	X	Y	Z	TEMPERATURE
1	43.28	38.44	21.95	0
2	35.97	32.08	21.37	0
3	0	48.2	21.5	0
4	0	57.89	22.08	0
5	30.12	37.63	21.67	0
6	36.18	45.2	22.26	0
7	23.37	42.15	21.84	0
8	28.08	50.63	22.42	0
9	15.96	45.48	21.86	0
10	19.17	54.63	22.45	0
11	8.1	47.52	21.75	0
12	9.728	57.07	22.33	0
13	26.84	40.04	21.77	0
14	32.24	48.09	22.36	0
15	19.74	43.97	21.87	0
16	23.7	52.82	22.45	0
17	12.07	46.66	21.82	0
18	14.5	56.05	22.41	0
19	4.06	48.03	21.64	0
20	4.879	57.69	22.22	0
21	33.18	34.96	21.54	0

Sovrapasso di ingresso - Ponte strallato - Relazione di calcolo

22	39.85	41.99	22.12	0
23	-43.29	38.44	19.67	0
24	-35.97	32.08	19.09	0
25	-30.12	37.63	19.59	0
26	-36.18	45.2	20.18	0
27	-23.37	42.15	20.1	0
28	-28.08	50.63	20.68	0
29	-15.96	45.48	20.61	0
30	-19.17	54.63	21.19	0
31	-8.1	47.52	21.1	0
32	-9.728	57.07	21.69	0
33	-26.84	40.04	19.85	0
34	-32.24	48.09	20.43	0
35	-19.74	43.97	20.35	0
36	-23.7	52.82	20.94	0
37	-12.07	46.66	20.86	0
38	-14.5	56.05	21.44	0
39	-4.06	48.03	21.32	0
40	-4.879	57.69	21.9	0
41	-33.18	34.96	19.34	0
42	-39.85	41.99	19.92	0
43	39.86	35.46	21.68	0
44	0	53.35	21.81	0
45	33.34	41.65	21.98	0
46	25.87	46.66	22.15	0
47	17.66	50.34	22.17	0
48	8.965	52.59	22.06	0
49	29.71	44.31	22.08	0
50	21.84	48.67	22.18	0
51	13.36	51.65	22.13	0
52	4.495	53.16	21.95	0
53	36.73	38.7	21.85	0
54	-39.86	35.46	19.4	0
55	-33.34	41.65	19.9	0
56	-25.87	46.66	20.41	0
57	-17.66	50.34	20.91	0
58	-8.965	52.59	21.41	0
59	-29.71	44.31	20.16	0
60	-21.84	48.67	20.66	0
61	-13.36	51.65	21.17	0
62	-4.495	53.16	21.63	0
63	-36.73	38.7	19.65	0
64	39.43	35.94	21.7	0
65	38.99	36.41	21.73	0
66	38.61	36.82	21.75	0
67	38.05	37.4	21.78	0
68	37.65	37.8	21.8	0
69	37.2	38.25	21.83	0
70	36.26	39.13	21.87	0
71	35.78	39.57	21.89	0
72	35.37	39.95	21.91	0
73	34.76	40.47	21.93	0
74	34.34	40.84	21.95	0
75	33.84	41.25	21.97	0
76	32.83	42.05	22	0
77	32.32	42.45	22.01	0
78	31.87	42.78	22.03	0
79	31.23	43.26	22.04	0
80	30.77	43.59	22.06	0
81	30.24	43.95	22.07	0
82	29.17	44.67	22.09	0
83	28.63	45.02	22.1	0
84	28.16	45.32	22.11	0
85	27.47	45.73	22.12	0
86	26.98	46.02	22.13	0
87	26.43	46.34	22.14	0
88	25.31	46.97	22.15	0
89	24.73	47.27	22.16	0
90	24.24	47.53	22.16	0
91	23.52	47.89	22.17	0
92	23.01	48.14	22.17	0
93	22.43	48.41	22.18	0
94	21.26	48.94	22.18	0
95	20.66	49.19	22.18	0
96	20.14	49.4	22.18	0
97	19.4	49.7	22.18	0
98	18.88	49.9	22.18	0
99	18.27	50.13	22.18	0
100	17.06	50.55	22.17	0
101	16.45	50.75	22.17	0
102	15.91	50.93	22.16	0
103	15.14	51.16	22.15	0
104	14.6	51.31	22.15	0
105	13.98	51.49	22.14	0
106	12.74	51.81	22.13	0
107	12.11	51.95	22.12	0
108	11.56	52.08	22.11	0
109	10.78	52.25	22.09	0
110	10.23	52.37	22.08	0
111	9.595	52.48	22.07	0
112	8.325	52.7	22.05	0
113	7.69	52.8	22.03	0
114	7.129	52.88	22.02	0
115	6.336	52.97	22	0
116	5.775	53.04	21.98	0
117	5.135	53.1	21.97	0
118	3.855	53.22	21.93	0
119	3.21	53.25	21.91	0
120	2.65	53.28	21.89	0
121	1.845	53.32	21.87	0

Sovrapasso di ingresso - Ponte strallato - Relazione di calcolo

122	1.285	53.33	21.85	0
123	0.645	53.35	21.83	0
124	-39.43	35.94	19.44	0
125	-38.99	36.41	19.47	0
126	-38.61	36.82	19.5	0
127	-38.05	37.4	19.55	0
128	-37.65	37.8	19.58	0
129	-37.2	38.25	19.61	0
130	-36.26	39.13	19.69	0
131	-35.78	39.57	19.72	0
132	-35.37	39.95	19.76	0
133	-34.76	40.47	19.8	0
134	-34.34	40.84	19.83	0
135	-33.84	41.25	19.87	0
136	-32.83	42.05	19.94	0
137	-32.32	42.45	19.98	0
138	-31.87	42.78	20.01	0
139	-31.23	43.26	20.05	0
140	-30.77	43.59	20.09	0
141	-30.24	43.95	20.12	0
142	-29.17	44.67	20.19	0
143	-28.63	45.02	20.23	0
144	-28.16	45.32	20.26	0
145	-27.47	45.73	20.31	0
146	-26.98	46.02	20.34	0
147	-26.43	46.34	20.37	0
148	-25.31	46.97	20.45	0
149	-24.73	47.27	20.48	0
150	-24.24	47.53	20.52	0
151	-23.52	47.89	20.56	0
152	-23.01	48.14	20.59	0
153	-22.43	48.41	20.63	0
154	-21.26	48.94	20.7	0
155	-20.66	49.19	20.74	0
156	-20.14	49.4	20.77	0
157	-19.4	49.7	20.81	0
158	-18.88	49.9	20.85	0
159	-18.27	50.13	20.88	0
160	-17.06	50.55	20.95	0
161	-16.45	50.75	20.99	0
162	-15.91	50.93	21.02	0
163	-15.14	51.16	21.07	0
164	-14.6	51.31	21.1	0
165	-13.98	51.49	21.13	0
166	-12.74	51.81	21.2	0
167	-12.11	51.95	21.24	0
168	-11.56	52.08	21.27	0
169	-10.78	52.25	21.32	0
170	-10.23	52.37	21.35	0
171	-9.595	52.48	21.38	0
172	-8.325	52.7	21.45	0
173	-7.69	52.8	21.48	0
174	-7.129	52.88	21.5	0
175	-6.336	52.97	21.54	0
176	-5.775	53.04	21.57	0
177	-5.135	53.1	21.6	0
178	-3.855	53.22	21.66	0
179	-3.21	53.25	21.68	0
180	-2.65	53.28	21.7	0
181	-1.845	53.32	21.74	0
182	-1.285	53.33	21.76	0
183	-0.645	53.35	21.78	0
184	41.47	36.87	21.81	0
185	-41.48	36.87	19.53	0
186	0	55.5	21.94	0
205	0	50	21.61	0
224	37.33	33.26	21.48	0
225	-37.33	33.27	19.2	0
226	42.83	38.05	21.92	0
227	-42.84	38.05	19.64	0
228	0	57.29	22.04	0
229	35.8	44.73	22.22	0
230	27.78	50.1	22.39	0
231	18.97	54.06	22.41	0
232	9.627	56.48	22.3	0
233	31.91	47.59	22.32	0
234	23.46	52.27	22.42	0
235	14.35	55.47	22.37	0
236	4.828	57.09	22.19	0
237	39.44	41.55	22.09	0
238	-35.8	44.73	20.14	0
239	-27.78	50.1	20.65	0
240	-18.97	54.06	21.15	0
241	-9.627	56.48	21.65	0
242	-31.91	47.59	20.39	0
243	-23.46	52.27	20.9	0
244	-14.35	55.47	21.41	0
245	-4.828	57.09	21.87	0
246	-39.44	41.55	19.89	0
346	34.68	43.33	22.11	0
347	26.91	48.53	22.28	0
348	18.38	52.37	22.3	0
349	9.326	54.71	22.19	0
350	30.91	46.1	22.21	0
351	22.72	50.63	22.31	0
352	13.9	53.73	22.26	0
353	4.676	55.3	22.08	0
354	38.2	40.25	21.98	0
355	-34.68	43.33	20.03	0
356	-26.91	48.53	20.54	0

Sovrapasso di ingresso - Ponte strallato - Relazione di calcolo

357	-18.38	52.37	21.04	0
358	-9.326	54.71	21.54	0
359	-30.91	46.1	20.29	0
360	-22.72	50.63	20.79	0
361	-13.9	53.73	21.3	0
362	-4.676	55.3	21.76	0
363	-38.2	40.25	19.78	0
366	36.58	32.61	21.42	0
367	-36.58	32.61	19.14	0
368	0	49.01	21.55	0
369	30.63	38.26	21.72	0
370	23.76	42.86	21.89	0
371	16.23	46.24	21.91	0
372	8.235	48.31	21.8	0
373	27.29	40.71	21.82	0
374	20.07	44.71	21.92	0
375	12.27	47.45	21.87	0
376	4.128	48.83	21.69	0
377	33.74	35.55	21.59	0
378	-30.63	38.26	19.64	0
379	-23.76	42.86	20.15	0
380	-16.23	46.24	20.65	0
381	-8.235	48.31	21.15	0
382	-27.29	40.71	19.89	0
383	-20.07	44.71	20.4	0
384	-12.27	47.45	20.91	0
385	-4.128	48.83	21.37	0
386	-33.74	35.55	19.39	0
387	-40.19	35.09	19.37	0
388	40.19	35.09	21.66	0
389	0	50	20.93	0
390	37.33	33.26	20.8	0
391	-37.33	33.27	18.52	0
392	41.47	36.87	20.8	0
393	-41.48	36.87	18.52	0
394	0	55.5	20.93	0
395	0	50	20.78	0
396	37.33	33.26	20.65	0
397	-37.33	33.27	18.37	0
398	41.47	36.87	20.65	0
399	-41.48	36.87	18.37	0
400	0	55.5	20.78	0
401	0	50	20.48	0
402	37.33	33.26	20.35	0
403	-37.33	33.27	18.07	0
404	41.47	36.87	20.35	0
405	-41.48	36.87	18.07	0
406	0	55.5	20.48	0
407	-39.87	34.54	18.07	0
408	39.86	34.53	20.35	0
409	-39.87	34.54	10.47	0
410	39.86	34.53	14.25	0
417	0	58.73	20.48	0
497	-39.87	34.54	8.474	0
498	39.86	34.53	12.25	0
500	0	54.75	11.93	0
501	0.5	68.24	41.28	0
502	0.5	67.72	40.2	0
503	0.5	67.21	39.11	0
504	0.5	66.7	38.03	0
505	0.5	66.19	36.94	0
506	0.5	65.68	35.86	0
507	0.5	64.65	33.69	0
509	0.5	63.63	31.52	0
510	-0.5	68.24	41.28	0
511	-0.5	67.72	40.2	0
512	-0.5	67.21	39.11	0
513	-0.5	66.7	38.03	0
514	-0.5	66.19	36.94	0
515	-0.5	65.68	35.86	0
516	-0.5	64.65	33.69	0
518	-0.5	63.63	31.52	0
519	-0.5	58.43	20.48	0
521	-0.5	68.79	42.46	0
527	0.5	58.43	20.48	0
529	0.5	68.79	42.46	0
597	-38.33	37.11	19.53	0
598	-35.06	40.21	19.78	0
599	-31.55	43.02	20.03	0
600	-27.81	45.52	20.29	0
601	-23.88	47.71	20.54	0
602	-19.77	49.55	20.79	0
603	-15.53	51.04	21.04	0
604	-11.17	52.17	21.29	0
605	-6.732	52.93	21.52	0
606	-2.247	53.3	21.72	0
607	2.247	53.3	21.88	0
608	6.732	52.93	22.01	0
609	11.17	52.17	22.1	0
610	15.53	51.04	22.16	0
611	19.77	49.55	22.18	0
612	23.88	47.71	22.17	0
613	27.81	45.52	22.12	0
614	31.55	43.02	22.04	0
615	35.06	40.21	21.92	0
616	38.33	37.11	21.77	0
617	-39.87	34.54	15.89	0
618	39.86	34.53	18.17	0
619	0	49.37	20.48	0
620	0	49.2	19.78	0

Sovrapasso di ingresso - Ponte strallato - Relazione di calcolo

621	0	49.93	19.16	0
622	0	50.79	18.43	0
623	0	51.7	17.66	0
624	0	50.43	17.66	0
625	0	49.98	16.72	0
626	0	49.53	15.77	0
627	0	49.1	14.82	0
628	0	48.64	13.88	0
629	0	48.19	12.93	0
630	0	49.46	12.93	0
631	0	53.63	12.93	0
632	0	55.16	12.93	0
633	0	56.78	12.93	0
634	0	58.05	12.93	0
635	0	57.2	20.48	0
636	0	60.01	20.48	0
639	0	61.01	20.48	0
642	0	53.04	20.48	0
643	0	52.71	19.78	0
644	0	52.42	19.16	0
645	0	52.07	18.43	0
646	0	51.26	16.72	0
647	0	50.81	15.77	0
648	0	50.36	14.82	0
649	0	49.91	13.88	0
650	0	55.87	17.66	0
651	0	56.86	19.78	0
652	0	56.57	19.16	0
653	0	56.23	18.43	0
654	0	55.42	16.72	0
655	0	54.97	15.77	0
656	0	54.53	14.82	0
657	0	54.08	13.88	0
658	0	57.4	17.66	0
659	0	58.39	19.78	0
660	0	58.1	19.16	0
661	0	57.76	18.43	0
662	0	56.95	16.72	0
663	0	56.5	15.77	0
664	0	56.06	14.82	0
665	0	55.61	13.88	0
666	0	58.8	17.66	0
667	0	59.71	19.78	0
668	0	59.44	19.16	0
669	0	59.13	18.43	0
670	0	58.4	16.72	0
671	0	58	15.77	0
672	0	57.59	14.82	0
673	0	57.19	13.88	0
674	0	59.9	17.66	0
675	0	60.73	19.78	0
676	0	60.49	19.16	0
677	0	60.2	18.43	0
678	0	59.54	16.72	0
679	0	59.16	15.77	0
680	0	58.79	14.82	0
681	0	58.43	13.88	0
682	0	51.77	20.48	0
683	0	49.97	19.78	0
684	0	50.79	20.48	0
685	0	50.79	19.16	0
686	0	50.79	19.78	0
687	0	51.14	19.16	0
688	0	51.43	19.78	0
689	0	51.93	12.93	0
690	0	54.17	17.66	0
691	0	55.16	19.78	0
692	0	54.87	19.16	0
693	0	54.53	18.43	0
694	0	53.72	16.72	0
695	0	53.27	15.77	0
696	0	52.83	14.82	0
697	0	52.38	13.88	0
698	0	54.3	20.48	0
699	0	50.73	12.93	0
700	0	52.97	17.66	0
701	0	53.96	19.78	0
702	0	53.67	19.16	0
703	0	53.33	18.43	0
704	0	52.52	16.72	0
705	0	52.07	15.77	0
706	0	51.63	14.82	0
707	0	51.18	13.88	0
708	-0.5	63.37	30.97	0
709	0.5	63.37	30.97	0
710	-0.5	64.4	33.14	0
711	0.5	64.4	33.14	0
712	-0.5	65.42	35.32	0
713	0.5	65.42	35.32	0
714	-0.5	67.47	39.66	0
715	-0.5	66.44	37.49	0
716	0.5	67.47	39.66	0
717	0.5	66.44	37.49	0
718	-0.5	68.49	41.83	0
719	0.5	68.49	41.83	0
720	-0.5	62.52	30.97	0
721	0.5	62.52	30.97	0
722	-0.5	63.55	33.14	0
723	0.5	63.55	33.14	0
724	-0.5	64.57	35.32	0

Sovrapasso di ingresso - Ponte strallato - Relazione di calcolo

725	0.5	64.57	35.32	0
726	-0.5	66.62	39.66	0
727	-0.5	65.59	37.49	0
728	0.5	66.62	39.66	0
729	0.5	65.59	37.49	0
730	-0.5	67.64	41.83	0
731	0.5	67.64	41.83	0
732	-0.5	64.47	30.97	0
733	0.5	64.47	30.97	0
734	-0.5	65.4	33.14	0
735	0.5	65.4	33.14	0
736	-0.5	66.32	35.32	0
737	0.5	66.32	35.32	0
738	-0.5	68.17	39.66	0
739	-0.5	67.24	37.49	0
740	0.5	68.17	39.66	0
741	0.5	67.24	37.49	0
742	-0.5	69.09	41.83	0
743	0.5	69.09	41.83	0
744	-0.5	62.35	28.8	0
745	-0.5	61.5	28.8	0
746	0.5	62.35	28.8	0
747	0.5	61.5	28.8	0
748	-0.5	63.55	28.8	0
749	0.5	63.55	28.8	0
750	-0.5	61.33	26.63	0
751	-0.5	60.48	26.63	0
752	0.5	61.33	26.63	0
753	0.5	60.48	26.63	0
754	-0.5	62.63	26.63	0
755	0.5	62.63	26.63	0
756	-0.5	60.3	24.46	0
757	-0.5	59.45	24.46	0
758	0.5	60.3	24.46	0
759	0.5	59.45	24.46	0
760	-0.5	61.7	24.46	0
761	0.5	61.7	24.46	0
762	-0.5	59.28	22.29	0
763	-0.5	58.43	22.29	0
764	0.5	59.28	22.29	0
765	0.5	58.43	22.29	0
766	-0.5	60.78	22.29	0
767	0.5	60.78	22.29	0
768	-0.5	57.58	20.48	0
769	0.5	57.58	20.48	0
770	-0.5	60.01	20.48	0
771	0.5	60.01	20.48	0
772	-39.87	34.54	17.02	0
773	39.86	34.53	19.3	0
774	-4.4	47.95	11.93	0
775	4.4	47.95	11.93	0
776	4.4	61.55	11.93	0
777	-4.4	61.55	11.93	0
778	-0.5	58.05	11.93	0
779	0.5	58.05	11.93	0
780	0.9	56.78	11.93	0
781	-0.9	56.78	11.93	0
782	-0.9	49.46	11.93	0
783	0.9	49.46	11.93	0
784	0.5	48.19	11.93	0
785	-0.5	48.19	11.93	0
786	-3.6	60.75	11.93	0
787	-1.2	60.75	11.93	0
788	1.2	60.75	11.93	0
789	3.6	60.75	11.93	0
790	3.6	58.35	11.93	0
791	1.2	58.35	11.93	0
792	-1.2	58.35	11.93	0
793	-3.6	58.35	11.93	0
794	-3.6	55.95	11.93	0
795	-1.2	55.95	11.93	0
796	1.2	55.95	11.93	0
797	3.6	55.95	11.93	0
798	3.6	53.55	11.93	0
799	1.2	53.55	11.93	0
800	-1.2	53.55	11.93	0
801	-3.6	53.55	11.93	0
802	-3.6	51.15	11.93	0
803	-1.2	51.15	11.93	0
804	1.2	51.15	11.93	0
805	3.6	51.15	11.93	0
806	3.6	48.75	11.93	0
807	1.2	48.75	11.93	0
808	-1.2	48.75	11.93	0
809	-3.6	48.75	11.93	0
810	3.6	54.75	11.93	0
811	1.2	54.75	11.93	0
812	-1.2	54.75	11.93	0
813	-3.6	54.75	11.93	0
814	0	61.55	11.93	0
815	3.6	61.55	11.93	0
816	1.2	61.55	11.93	0
817	-1.2	61.55	11.93	0
818	-3.6	61.55	11.93	0
819	0	47.95	11.93	0
820	3.6	47.95	11.93	0
821	1.2	47.95	11.93	0
822	-1.2	47.95	11.93	0
823	-3.6	47.95	11.93	0
824	-3.6	56.78	11.93	0

Sovrapasso di ingresso - Ponte strallato - Relazione di calcolo

825	-3.6	50.06	11.93	0
826	3.6	56.78	11.93	0
827	3.6	50.06	11.93	0
828	0	53.55	11.93	0
829	0	55.95	11.93	0
830	0	50.55	11.93	0
831	0	49.46	11.93	0
832	0	56.78	11.93	0
833	-4.4	60.75	11.93	0
834	-4.4	58.35	11.93	0
835	-4.4	55.95	11.93	0
836	-4.4	53.55	11.93	0
837	-4.4	51.15	11.93	0
838	-4.4	48.75	11.93	0
839	-4.4	54.75	11.93	0
840	-4.4	56.78	11.93	0
841	-4.4	50.06	11.93	0
842	4.4	60.75	11.93	0
843	4.4	58.35	11.93	0
844	4.4	55.95	11.93	0
845	4.4	53.55	11.93	0
846	4.4	51.15	11.93	0
847	4.4	48.75	11.93	0
848	4.4	54.75	11.93	0
849	4.4	56.78	11.93	0
850	4.4	50.06	11.93	0
851	-0.9	54.75	11.93	0
852	-0.9	53.55	11.93	0
853	-0.9	55.95	11.93	0
854	-0.9	50.55	11.93	0
855	0.9	54.75	11.93	0
856	0.9	53.55	11.93	0
857	0.9	55.95	11.93	0
858	0.9	50.55	11.93	0
859	0	58.35	11.93	0
860	0	60.75	11.93	0
861	-3.12	60.75	11.93	0
862	-2.64	60.75	11.93	0
863	-2.16	60.75	11.93	0
864	-1.68	60.75	11.93	0
865	-3.12	61.55	11.93	0
866	-2.64	61.55	11.93	0
867	-2.16	61.55	11.93	0
868	-1.68	61.55	11.93	0
869	1.68	60.75	11.93	0
870	2.16	60.75	11.93	0
871	2.64	60.75	11.93	0
872	3.12	60.75	11.93	0
873	1.68	61.55	11.93	0
874	2.16	61.55	11.93	0
875	2.64	61.55	11.93	0
876	3.12	61.55	11.93	0
877	-3.12	47.95	11.93	0
878	-2.64	47.95	11.93	0
879	-2.16	47.95	11.93	0
880	-1.68	47.95	11.93	0
881	-3.12	48.75	11.93	0
882	-2.64	48.75	11.93	0
883	-2.16	48.75	11.93	0
884	-1.68	48.75	11.93	0
885	-3.06	50.06	11.93	0
886	-2.52	50.06	11.93	0
887	-1.98	50.06	11.93	0
888	-1.44	50.06	11.93	0
889	-3.12	51.15	11.93	0
890	-2.64	51.15	11.93	0
891	-2.16	51.15	11.93	0
892	-1.68	51.15	11.93	0
893	-3.12	53.55	11.93	0
894	-2.64	53.55	11.93	0
895	-2.16	53.55	11.93	0
896	-1.68	53.55	11.93	0
897	-3.12	54.75	11.93	0
898	-2.64	54.75	11.93	0
899	-2.16	54.75	11.93	0
900	-1.68	54.75	11.93	0
901	-3.12	55.95	11.93	0
902	-2.64	55.95	11.93	0
903	-2.16	55.95	11.93	0
904	-1.68	55.95	11.93	0
905	-3.06	56.78	11.93	0
906	-2.52	56.78	11.93	0
907	-1.98	56.78	11.93	0
908	-1.44	56.78	11.93	0
909	-3.12	58.35	11.93	0
910	-2.64	58.35	11.93	0
911	-2.16	58.35	11.93	0
912	-1.68	58.35	11.93	0
913	1.68	58.35	11.93	0
914	2.16	58.35	11.93	0
915	2.64	58.35	11.93	0
916	3.12	58.35	11.93	0
917	1.68	47.95	11.93	0
918	2.16	47.95	11.93	0
919	2.64	47.95	11.93	0
920	3.12	47.95	11.93	0
921	1.68	48.75	11.93	0
922	2.16	48.75	11.93	0
923	2.64	48.75	11.93	0
924	3.12	48.75	11.93	0

Sovrapasso di ingresso - Ponte strallato - Relazione di calcolo

925	1.44	50.06	11.93	0
926	1.98	50.06	11.93	0
927	2.52	50.06	11.93	0
928	3.06	50.06	11.93	0
929	1.68	51.15	11.93	0
930	2.16	51.15	11.93	0
931	2.64	51.15	11.93	0
932	3.12	51.15	11.93	0
933	1.68	53.55	11.93	0
934	2.16	53.55	11.93	0
935	2.64	53.55	11.93	0
936	3.12	53.55	11.93	0
937	1.68	54.75	11.93	0
938	2.16	54.75	11.93	0
939	2.64	54.75	11.93	0
940	3.12	54.75	11.93	0
941	1.68	55.95	11.93	0
942	2.16	55.95	11.93	0
943	2.64	55.95	11.93	0
944	3.12	55.95	11.93	0
945	1.44	56.78	11.93	0
946	1.98	56.78	11.93	0
947	2.52	56.78	11.93	0
948	3.06	56.78	11.93	0
949	-4.4	51.63	11.93	0
950	-3.6	51.63	11.93	0
951	-4.4	52.11	11.93	0
952	-3.6	52.11	11.93	0
953	-4.4	52.59	11.93	0
954	-3.6	52.59	11.93	0
955	-4.4	53.07	11.93	0
956	-3.6	53.07	11.93	0
957	-4.4	58.83	11.93	0
958	-3.6	58.83	11.93	0
959	-4.4	59.31	11.93	0
960	-3.6	59.31	11.93	0
961	-4.4	59.79	11.93	0
962	-3.6	59.79	11.93	0
963	-4.4	60.27	11.93	0
964	-3.6	60.27	11.93	0
965	-1.2	51.63	11.93	0
966	-0.9	51.03	11.93	0
967	-1.2	52.11	11.93	0
968	-0.9	51.51	11.93	0
969	-1.2	52.59	11.93	0
970	-0.9	51.99	11.93	0
971	-1.2	53.07	11.93	0
972	-0.9	52.77	11.93	0
973	0	51.03	11.93	0
974	0	51.51	11.93	0
975	0	51.99	11.93	0
976	0	52.77	11.93	0
977	0.9	51.03	11.93	0
978	0.9	51.51	11.93	0
979	0.9	51.99	11.93	0
980	0.9	52.77	11.93	0
981	1.2	51.63	11.93	0
982	1.2	52.11	11.93	0
983	1.2	52.59	11.93	0
984	1.2	53.07	11.93	0
985	-3.12	51.63	11.93	0
986	-3.12	52.11	11.93	0
987	-3.12	52.59	11.93	0
988	-3.12	53.07	11.93	0
989	-3.12	58.83	11.93	0
990	-3.12	59.31	11.93	0
991	-3.12	59.79	11.93	0
992	-3.12	60.27	11.93	0
993	-1.2	58.83	11.93	0
994	0	58.83	11.93	0
995	-1.2	59.31	11.93	0
996	0	59.31	11.93	0
997	-1.2	59.79	11.93	0
998	0	59.79	11.93	0
999	-1.2	60.27	11.93	0
1000	0	60.27	11.93	0
1001	1.2	58.83	11.93	0
1002	1.2	59.31	11.93	0
1003	1.2	59.79	11.93	0
1004	1.2	60.27	11.93	0
1005	1.68	58.83	11.93	0
1006	1.68	59.31	11.93	0
1007	1.68	59.79	11.93	0
1008	1.68	60.27	11.93	0
1009	3.6	58.83	11.93	0
1010	4.4	58.83	11.93	0
1011	3.6	59.31	11.93	0
1012	4.4	59.31	11.93	0
1013	3.6	59.79	11.93	0
1014	4.4	59.79	11.93	0
1015	3.6	60.27	11.93	0
1016	4.4	60.27	11.93	0
1017	3.6	51.63	11.93	0
1018	4.4	51.63	11.93	0
1019	3.6	52.11	11.93	0
1020	4.4	52.11	11.93	0
1021	3.6	52.59	11.93	0
1022	4.4	52.59	11.93	0
1023	3.6	53.07	11.93	0
1024	4.4	53.07	11.93	0

Sovrapasso di ingresso - Ponte strallato - Relazione di calcolo

1025	1.68	51.63	11.93	0
1026	1.68	52.11	11.93	0
1027	1.68	52.59	11.93	0
1028	1.68	53.07	11.93	0
1029	-2.64	51.63	11.93	0
1030	-2.64	52.11	11.93	0
1031	-2.64	52.59	11.93	0
1032	-2.64	53.07	11.93	0
1033	-2.16	51.63	11.93	0
1034	-2.16	52.11	11.93	0
1035	-2.16	52.59	11.93	0
1036	-2.16	53.07	11.93	0
1037	-1.68	51.63	11.93	0
1038	-1.68	52.11	11.93	0
1039	-1.68	52.59	11.93	0
1040	-1.68	53.07	11.93	0
1041	-2.64	58.83	11.93	0
1042	-2.64	59.31	11.93	0
1043	-2.64	59.79	11.93	0
1044	-2.64	60.27	11.93	0
1045	-2.16	58.83	11.93	0
1046	-2.16	59.31	11.93	0
1047	-2.16	59.79	11.93	0
1048	-2.16	60.27	11.93	0
1049	-1.68	58.83	11.93	0
1050	-1.68	59.31	11.93	0
1051	-1.68	59.79	11.93	0
1052	-1.68	60.27	11.93	0
1053	2.16	58.83	11.93	0
1054	2.16	59.31	11.93	0
1055	2.16	59.79	11.93	0
1056	2.16	60.27	11.93	0
1057	2.64	58.83	11.93	0
1058	2.64	59.31	11.93	0
1059	2.64	59.79	11.93	0
1060	2.64	60.27	11.93	0
1061	3.12	58.83	11.93	0
1062	3.12	59.31	11.93	0
1063	3.12	59.79	11.93	0
1064	3.12	60.27	11.93	0
1065	2.16	51.63	11.93	0
1066	2.16	52.11	11.93	0
1067	2.16	52.59	11.93	0
1068	2.16	53.07	11.93	0
1069	2.64	51.63	11.93	0
1070	2.64	52.11	11.93	0
1071	2.64	52.59	11.93	0
1072	2.64	53.07	11.93	0
1073	3.12	51.63	11.93	0
1074	3.12	52.11	11.93	0
1075	3.12	52.59	11.93	0
1076	3.12	53.07	11.93	0
1077	-0.6	60.75	11.93	0
1078	-0.6	61.55	11.93	0
1079	0.6	60.75	11.93	0
1080	0.6	61.55	11.93	0
1081	-0.6	58.35	11.93	0
1082	-0.6	58.83	11.93	0
1083	0.6	58.35	11.93	0
1084	0.6	58.83	11.93	0
1085	-0.6	59.31	11.93	0
1086	-0.6	59.79	11.93	0
1087	-0.6	60.27	11.93	0
1088	0.6	59.31	11.93	0
1089	0.6	59.79	11.93	0
1090	0.6	60.27	11.93	0
1091	-4.4	57.31	11.93	0
1092	-3.6	57.31	11.93	0
1093	-4.4	57.83	11.93	0
1094	-3.6	57.83	11.93	0
1095	-3.08	57.31	11.93	0
1096	-3.1	57.83	11.93	0
1097	3.6	57.31	11.93	0
1098	4.4	57.31	11.93	0
1099	3.6	57.83	11.93	0
1100	4.4	57.83	11.93	0
1101	1	57.31	11.93	0
1102	1.52	57.31	11.93	0
1103	1.1	57.83	11.93	0
1104	1.6	57.83	11.93	0
1105	-2.56	57.31	11.93	0
1106	-2.6	57.83	11.93	0
1107	-2.04	57.31	11.93	0
1108	-2.1	57.83	11.93	0
1109	-1.52	57.31	11.93	0
1110	-1.6	57.83	11.93	0
1111	-1	57.31	11.93	0
1112	-1.1	57.83	11.93	0
1113	2.04	57.31	11.93	0
1114	2.1	57.83	11.93	0
1115	2.56	57.31	11.93	0
1116	2.6	57.83	11.93	0
1117	3.08	57.31	11.93	0
1118	3.1	57.83	11.93	0
1119	-4.4	56.37	11.93	0
1120	-3.6	56.37	11.93	0
1121	-3.09	56.37	11.93	0
1122	3.6	56.37	11.93	0
1123	4.4	56.37	11.93	0
1124	1.05	56.37	11.93	0

Sovrapasso di ingresso - Ponte strallato - Relazione di calcolo

1125	1.56	56.37	11.93	0
1126	-2.58	56.37	11.93	0
1127	-2.07	56.37	11.93	0
1128	-1.56	56.37	11.93	0
1129	-1.05	56.37	11.93	0
1130	2.07	56.37	11.93	0
1131	2.58	56.37	11.93	0
1132	3.09	56.37	11.93	0
1133	-4.4	54.15	11.93	0
1134	-3.6	54.15	11.93	0
1135	-4.4	55.35	11.93	0
1136	-3.6	55.35	11.93	0
1137	-1.2	54.15	11.93	0
1138	-0.9	54.15	11.93	0
1139	-1.2	55.35	11.93	0
1140	-0.9	55.35	11.93	0
1141	0	54.15	11.93	0
1142	0.9	54.15	11.93	0
1143	0	55.35	11.93	0
1144	0.9	55.35	11.93	0
1145	1.2	54.15	11.93	0
1146	1.2	55.35	11.93	0
1147	-3.12	54.15	11.93	0
1148	-3.12	55.35	11.93	0
1149	3.6	54.15	11.93	0
1150	4.4	54.15	11.93	0
1151	3.6	55.35	11.93	0
1152	4.4	55.35	11.93	0
1153	1.68	54.15	11.93	0
1154	1.68	55.35	11.93	0
1155	-2.64	54.15	11.93	0
1156	-2.16	54.15	11.93	0
1157	-1.68	54.15	11.93	0
1158	-2.64	55.35	11.93	0
1159	-2.16	55.35	11.93	0
1160	-1.68	55.35	11.93	0
1161	2.16	54.15	11.93	0
1162	2.64	54.15	11.93	0
1163	3.12	54.15	11.93	0
1164	2.16	55.35	11.93	0
1165	2.64	55.35	11.93	0
1166	3.12	55.35	11.93	0
1167	-4.4	50.61	11.93	0
1168	-3.6	50.61	11.93	0
1169	-3.09	50.61	11.93	0
1170	3.6	50.61	11.93	0
1171	4.4	50.61	11.93	0
1172	1.05	50.61	11.93	0
1173	1.56	50.61	11.93	0
1174	-2.58	50.61	11.93	0
1175	-2.07	50.61	11.93	0
1176	-1.56	50.61	11.93	0
1177	-1.05	50.61	11.93	0
1178	2.07	50.61	11.93	0
1179	2.58	50.61	11.93	0
1180	3.09	50.61	11.93	0
1181	-4.4	49.41	11.93	0
1182	-3.6	49.41	11.93	0
1183	-3.09	49.41	11.93	0
1184	3.6	49.41	11.93	0
1185	4.4	49.41	11.93	0
1186	1.05	49.41	11.93	0
1187	1.56	49.41	11.93	0
1188	-2.58	49.41	11.93	0
1189	-2.07	49.41	11.93	0
1190	-1.56	49.41	11.93	0
1191	-1.05	49.41	11.93	0
1192	2.07	49.41	11.93	0
1193	2.58	49.41	11.93	0
1194	3.09	49.41	11.93	0
1195	-0.9	50.01	11.93	0
1196	0	50.01	11.93	0
1197	0.9	50.01	11.93	0
1198	-0.6	47.95	11.93	0
1199	-0.85	48.77	11.93	0
1200	0.6	47.95	11.93	0
1201	0.85	48.77	11.93	0
1202	-0.7352	57.31	11.93	0
1203	0.7352	57.31	11.93	0
1204	-0.6937	48.81	11.93	0
1205	0.6937	48.81	11.93	0
1206	0	57.31	11.93	0
1207	0	58.05	11.93	0
1208	0	48.81	11.93	0
1209	-0.9	56.37	11.93	0
1210	0	56.37	11.93	0
1211	0.9	56.37	11.93	0
1212	0	48.19	11.93	0
1213	-3.6	60.75	10.93	0
1214	-1.2	60.75	10.93	0
1215	1.2	60.75	10.93	0
1216	3.6	60.75	10.93	0
1217	3.6	58.35	10.93	0
1218	1.2	58.35	10.93	0
1219	-1.2	58.35	10.93	0
1220	-3.6	58.35	10.93	0
1221	-3.6	55.95	10.93	0
1222	-1.2	55.95	10.93	0
1223	1.2	55.95	10.93	0
1224	3.6	55.95	10.93	0

Sovrapasso di ingresso - Ponte strallato - Relazione di calcolo

1225	3.6	53.55	10.93	0
1226	1.2	53.55	10.93	0
1227	-1.2	53.55	10.93	0
1228	-3.6	53.55	10.93	0
1229	-3.6	51.15	10.93	0
1230	-1.2	51.15	10.93	0
1231	1.2	51.15	10.93	0
1232	3.6	51.15	10.93	0
1233	3.6	48.75	10.93	0
1234	1.2	48.75	10.93	0
1235	-1.2	48.75	10.93	0
1236	-3.6	48.75	10.93	0
1237	-29.85	48.85	20.52	0
1238	-7.228	56.79	21.76	0
1239	7.228	56.79	22.24	0
1240	29.85	48.85	22.35	0
1241	41.93	37.26	21.84	0
1242	41.93	37.26	20.35	0
1243	41.93	37.26	20.84	0
1244	-41.93	37.26	19.56	0
1245	-41.93	37.26	18.07	0
1246	-41.93	37.26	18.56	0
1247	0	56.09	21.97	0
1248	0	56.09	20.48	0
1249	0	56.09	20.97	0

*** SUPPORT / SPECIFIED DISPLACEMENT / POINT SPRING SUPPORT

** SUPPORT / SPECIFIED DISPLACEMENT

NODE	SUPPORT DDDRR	SPECIFIED DISPLACEMENT					
		Dx	Dy	Dz	Rx	Ry	Rz
47	111000	0.0000	0.0000	0.0000	0.0000	0.0000	0.0000
57	111000	0.0000	0.0000	0.0000	0.0000	0.0000	0.0000
497	111111	0.0000	0.0000	0.0000	0.0000	0.0000	0.0000
498	111111	0.0000	0.0000	0.0000	0.0000	0.0000	0.0000

** POINT SPRING SUPPORT

NODE	TRANSLATIONAL DIRECTION			ROTATIONAL DIRECTION		
	SDx	SDy	SDz	SRx	SRy	SRz
1213	5000000.0000	5000000.0000	500000.0000	0.0000	0.0000	0.0000
1214	5000000.0000	5000000.0000	500000.0000	0.0000	0.0000	0.0000
1215	5000000.0000	5000000.0000	500000.0000	0.0000	0.0000	0.0000
1216	5000000.0000	5000000.0000	500000.0000	0.0000	0.0000	0.0000
1217	5000000.0000	5000000.0000	500000.0000	0.0000	0.0000	0.0000
1218	5000000.0000	5000000.0000	500000.0000	0.0000	0.0000	0.0000
1219	5000000.0000	5000000.0000	500000.0000	0.0000	0.0000	0.0000
1220	5000000.0000	5000000.0000	500000.0000	0.0000	0.0000	0.0000
1221	5000000.0000	5000000.0000	500000.0000	0.0000	0.0000	0.0000
1222	5000000.0000	5000000.0000	500000.0000	0.0000	0.0000	0.0000
1223	5000000.0000	5000000.0000	500000.0000	0.0000	0.0000	0.0000
1224	5000000.0000	5000000.0000	500000.0000	0.0000	0.0000	0.0000
1225	5000000.0000	5000000.0000	500000.0000	0.0000	0.0000	0.0000
1226	5000000.0000	5000000.0000	500000.0000	0.0000	0.0000	0.0000
1227	5000000.0000	5000000.0000	500000.0000	0.0000	0.0000	0.0000
1228	5000000.0000	5000000.0000	500000.0000	0.0000	0.0000	0.0000
1229	5000000.0000	5000000.0000	500000.0000	0.0000	0.0000	0.0000
1230	5000000.0000	5000000.0000	500000.0000	0.0000	0.0000	0.0000
1231	5000000.0000	5000000.0000	500000.0000	0.0000	0.0000	0.0000
1232	5000000.0000	5000000.0000	500000.0000	0.0000	0.0000	0.0000
1233	5000000.0000	5000000.0000	500000.0000	0.0000	0.0000	0.0000
1234	5000000.0000	5000000.0000	500000.0000	0.0000	0.0000	0.0000
1235	5000000.0000	5000000.0000	500000.0000	0.0000	0.0000	0.0000
1236	5000000.0000	5000000.0000	500000.0000	0.0000	0.0000	0.0000

*** FLOOR DIAPHRAGM / RIGID LINK DATA

MASTER	DDDRR	NODES OF SAME DISPLACEMENT					
497	111111	409					
498	111111	410					
500	111111	629to634	689	699	778to785	828to832 851to858 966to972by2	
		977to980	1138to1144by2	1195	1197	1202to1209 1211 1212	
1213	111111	786					
1214	111111	787					
1215	111111	788					
1216	111111	789					
1217	111111	790					
1218	111111	791					
1219	111111	792					
1220	111111	793					
1221	111111	794					
1222	111111	795					
1223	111111	796					
1224	111111	797					
1225	111111	798					
1226	111111	799					
1227	111111	800					
1228	111111	801					
1229	111111	802					
1230	111111	803					
1231	111111	804					
1232	111111	805					
1233	111111	806					
1234	111111	807					

1235 111111 808
1236 111111 809

*** SECTION PROPERTY DATA

NO	NAME	SHAPE	H	B	tw	tf1	r1
2	traversi	SR	1	0	0	0	0
4	el rigido	SR	0.5	0	0	0	0
5	tubo	P	0.406	0.016	0	0	0
8	baggiolo	SB	0.8	0.8	0	0	0
11	FLC48	GEN	0	0	0	0	0
40	A1s	GEN	0	0	0	0	0
41	A2s	GEN	0	0	0	0	0
42	A3s	GEN	0	0	0	0	0
43	A4s	GEN	0	0	0	0	0
44	A5s	GEN	0	0	0	0	0
45	A6s	GEN	0	0	0	0	0
46	A7s	GEN	0	0	0	0	0
47	A8s	GEN	0	0	0	0	0
48	A9s	GEN	0	0	0	0	0
49	A10s	GEN	0	0	0	0	0
50	A11s	GEN	0	0	0	0	0
51	A12s	GEN	0	0	0	0	0
52	A13s	GEN	0	0	0	0	0
59	31	GEN	0	0	0	0	0
60	A14s	GEN	0	0	0	0	0
61	A15s	GEN	0	0	0	0	0
62	A1d	GEN	0	0	0	0	0
63	A2d	GEN	0	0	0	0	0
66	fittizia	SR	0.01	0	0	0	0
67	Pila	GEN	0	0	0	0	0
68	A3d	GEN	0	0	0	0	0
69	A4d	GEN	0	0	0	0	0
70	A5d	GEN	0	0	0	0	0
71	A6d	GEN	0	0	0	0	0
72	A7d	GEN	0	0	0	0	0
73	A8d	GEN	0	0	0	0	0
74	A9d	GEN	0	0	0	0	0
75	A10d	GEN	0	0	0	0	0
76	A11d	GEN	0	0	0	0	0
77	A12d	GEN	0	0	0	0	0
78	A13d	GEN	0	0	0	0	0
79	A14d	GEN	0	0	0	0	0
80	A15d	GEN	0	0	0	0	0
84	tubo219.1-	P	0.219	0.012	0	0	0
85	2UPN220	2C	0.22	0.08	0.009	0.0125	0
94	A16s	GEN	0	0	0	0	0
95	A17s	GEN	0	0	0	0	0
96	A18s	GEN	0	0	0	0	0
97	A19s	GEN	0	0	0	0	0
98	A16d	GEN	0	0	0	0	0
99	A17d	GEN	0	0	0	0	0
100	A18d	GEN	0	0	0	0	0
101	A19d	GEN	0	0	0	0	0
102	Impalcato-	GEN	0	0	0	0	0
103	f-Impalca-	GEN	0	0	0	0	0

NO NAME STIFFNESS SCALE FACTOR

Sovrapasso di ingresso - Ponte strallato - Relazione di calcolo

	A	Asy	Asz	Ix	Iy	Iz	W	Boundary Group
2	traversi							
4	el rigido							
5	tubo							
8	baggiolo							
11	FLC48							
40	A1s							
41	A2s							
42	A3s							
43	A4s							
44	A5s							
45	A6s							
46	A7s							
47	A8s							
48	A9s							
49	A10s							
50	A11s							
51	A12s							
52	A13s							
59	31							
60	A14s							
61	A15s							
62	A1d							
63	A2d							
66	fittizia							
67	Pila							
68	A3d							
69	A4d							
70	A5d							
71	A6d							
72	A7d							
73	A8d							
74	A9d							
75	A10d							
76	A11d							
77	A12d							
78	A13d							
79	A14d							
80	A15d							
84	tubo219.1-							
85	2UPN220							
94	A16s							
95	A17s							
96	A18s							
97	A19s							
98	A16d							
99	A17d							
100	A18d							
101	A19d							
102	Impalcato-							
103	f-Impalca-							

NO	NAME	AREA [SRC:EQIV.]	MOMENT OF INERTIA			SHAPE FACTOR	
			Ix	Iy	Iz	k-Y	k-Z
2	traversi	0.7854	0.09817	0.04909	0.04909	0.9	0.9
4	el rigido	0.1963	0.006136	0.003068	0.003068	0.9	0.9
5	tubo	0.01962	0.000749	0.0003745	0.0003745	0.5	0.5
8	baggiolo	0.64	0.0576	0.03413	0.03413	0.8333	0.8333
11	FLC48	0.001551	0	0	0	0	0
40	A1s	2.579	0.6058	0.1895	1.614	0.8451	0.8376
		2.211	0.4341	0.1336	1.233	0.8427	0.8504
41	A2s	2.211	0.4341	0.1336	1.233	0.8427	0.8504
		2.133	0.4009	0.1228	1.161	0.8432	0.8287
42	A3s	2.133	0.4009	0.1228	1.161	0.8432	0.8287
		1.868	0.2989	0.09096	0.9217	0.8442	0.8278
43	A4s	1.868	0.2989	0.09096	0.9217	0.8442	0.8278
		1.787	0.2708	0.0821	0.8543	0.8439	0.8283
44	A5s	1.787	0.2708	0.0821	0.8543	0.8439	0.8283
		1.551	0.1976	0.05926	0.6723	0.8441	0.8349
45	A6s	1.551	0.1976	0.05926	0.6723	0.8441	0.8349
		1.476	0.177	0.0528	0.6186	0.8458	0.8362
46	A7s	1.476	0.177	0.0528	0.6186	0.8458	0.8362
		1.331	0.1405	0.04146	0.5205	0.8437	0.8398
47	A8s	1.331	0.1405	0.04146	0.5205	0.8437	0.8398
		1.261	0.1242	0.03651	0.4759	0.8433	0.8404
48	A9s	1.261	0.1242	0.03651	0.4759	0.8433	0.8404
		1.193	0.1094	0.03201	0.4341	0.8429	0.8411
49	A10s	1.193	0.1094	0.03201	0.4341	0.8429	0.8411
		1.061	0.08354	0.02423	0.3585	0.8424	0.8493
50	A11s	1.061	0.08354	0.02423	0.3585	0.8424	0.8493
		0.997	0.07236	0.02091	0.3244	0.8406	0.8433
51	A12s	0.997	0.07236	0.02091	0.3244	0.8406	0.8433
		0.9351	0.06241	0.01793	0.2927	0.842	0.8453
52	A13s	0.9351	0.06241	0.01793	0.2927	0.842	0.8453
		0.8161	0.04535	0.01291	0.2359	0.8398	0.847
59	31	0.00465	0	0	0	0	0
60	A14s	0.8161	0.04535	0.01291	0.2359	0.8398	0.847
		0.7591	0.03824	0.01083	0.2106	0.8385	0.851
61	A15s	0.7591	0.03824	0.01083	0.2106	0.8385	0.851
		0.6946	0.031	0.008714	0.1836	0.8395	0.8533
62	A1d	2.579	0.6082	0.1895	1.614	0.8483	0.8278
		2.211	0.434	0.1336	1.233	0.842	0.847
63	A2d	2.211	0.434	0.1336	1.233	0.842	0.847
		2.133	0.4009	0.1228	1.161	0.8432	0.8287
66	fittizia	7.854e-005	9.817e-010	4.909e-010	4.909e-010	0.9	0.9
67	Pila	5.805	4.213	1.362	5.354	0.8622	0.83
68	A3d	2.133	0.4009	0.1228	1.161	0.8432	0.8287

Sovrapasso di ingresso - Ponte strallato - Relazione di calcolo

69	A4d	1.868	0.2992	0.09096	0.9217	0.8447	0.8278
		1.868	0.2992	0.09096	0.9217	0.8447	0.8278
		1.787	0.2711	0.0821	0.8543	0.8443	0.8283
70	A5d	1.787	0.2711	0.0821	0.8543	0.8443	0.8283
		1.551	0.1979	0.05926	0.6723	0.8453	0.838
		1.551	0.1979	0.05926	0.6723	0.8453	0.838
71	A6d	1.476	0.177	0.0528	0.6186	0.8458	0.8362
		1.476	0.177	0.0528	0.6186	0.8458	0.8362
72	A7d	1.331	0.1404	0.04146	0.5205	0.8444	0.842
		1.331	0.1404	0.04146	0.5205	0.8444	0.842
73	A8d	1.261	0.1242	0.03651	0.4759	0.844	0.8426
		1.261	0.1242	0.03651	0.4759	0.844	0.8426
74	A9d	1.193	0.1093	0.03201	0.4341	0.8436	0.8433
		1.193	0.1093	0.03201	0.4341	0.8436	0.8433
75	A10d	1.061	0.08343	0.02423	0.3585	0.8407	0.8469
		1.061	0.08343	0.02423	0.3585	0.8407	0.8469
76	A11d	0.997	0.07231	0.02091	0.3244	0.8409	0.8452
		0.997	0.07231	0.02091	0.3244	0.8409	0.8452
77	A12d	0.9351	0.06241	0.01793	0.2927	0.842	0.8453
		0.9351	0.06241	0.01793	0.2927	0.842	0.8453
78	A13d	0.8161	0.04535	0.01291	0.2359	0.8398	0.8474
		0.8161	0.04535	0.01291	0.2359	0.8398	0.8474
79	A14d	0.7591	0.03825	0.01083	0.2106	0.8409	0.8494
		0.7591	0.03825	0.01083	0.2106	0.8409	0.8494
80	A15d	0.6946	0.031	0.008714	0.1836	0.8395	0.8536
		0.6946	0.031	0.008714	0.1836	0.8395	0.8536
84	tubo219.1-	0.007807	8.4e-005	4.2e-005	4.2e-005	0.5	0.5
85	2UPN220	0.00751	2.975e-007	5.423e-005	1.192e-005	0.4439	0.5273
94	A16s	4.053	1.576	0.5137	3.717	0.8491	0.8126
		3.843	1.437	0.4611	3.285	0.8481	0.8158
95	A17s	3.843	1.437	0.4611	3.285	0.8481	0.8158
		3.396	1.096	0.3505	2.63	0.8458	0.8364
96	A18s	3.396	1.096	0.3505	2.63	0.8458	0.8364
		2.974	0.8241	0.2609	2.076	0.8464	0.8361
97	A19s	2.974	0.8241	0.2609	2.076	0.8464	0.8361
		2.579	0.6058	0.1895	1.614	0.8451	0.8376
98	A16d	4.053	1.576	0.5137	3.717	0.8503	0.8239
		3.843	1.436	0.4611	3.285	0.8478	0.8182
99	A17d	3.843	1.436	0.4611	3.285	0.8478	0.8182
		3.396	1.096	0.3505	2.63	0.8456	0.8344
100	A18d	3.396	1.096	0.3505	2.63	0.8456	0.8344
		2.974	0.8251	0.2609	2.076	0.8469	0.839
101	A19d	2.974	0.8251	0.2609	2.076	0.8469	0.839
		2.579	0.6082	0.1895	1.614	0.8483	0.8278
102	Impalcato-	0.6479	0.2974	0.1546	4.024	0.6283	0.04744
103	f-Impalca-	0.6239	0.2974	0.1449	4.022	0.3976	0.0518

NO	NAME	SECTION MODULUS Sy		SECTION MODULUS Sz	
		I or CONC.	J or STEEL	I or CONC.	J or STEEL
2	traversi	0.09817	0.09817	0.09817	0.09817
4	el rigido	0.01227	0.01227	0.01227	0.01227
5	tubo	0.001843	0.001843	0.001843	0.001843
8	baggiolo	0.08533	0.08533	0.08533	0.08533
40	A1s	0	0	0	0
41	A2s	0	0	0	0
42	A3s	0	0	0	0
43	A4s	0	0	0	0
44	A5s	0	0	0	0
45	A6s	0	0	0	0
46	A7s	0	0	0	0
47	A8s	0	0	0	0
48	A9s	0	0	0	0
49	A10s	0	0	0	0
50	A11s	0	0	0	0
51	A12s	0	0	0	0
52	A13s	0	0	0	0
60	A14s	0	0	0	0
61	A15s	0	0	0	0
62	A1d	0	0	0	0
63	A2d	0	0	0	0
66	fittizia	9.817e-008	9.817e-008	9.817e-008	9.817e-008
68	A3d	0	0	0	0
69	A4d	0	0	0	0
70	A5d	0	0	0	0
71	A6d	0	0	0	0
72	A7d	0	0	0	0
73	A8d	0	0	0	0
74	A9d	0	0	0	0
75	A10d	0	0	0	0
76	A11d	0	0	0	0
77	A12d	0	0	0	0
78	A13d	0	0	0	0
79	A14d	0	0	0	0
80	A15d	0	0	0	0
84	tubo219.1-	0.0003834	0.0003834	0.0003834	0.0003834
85	2UPN220	0.000493	0.000493	0.0001355	0.0001355
94	A16s	0	0	0	0
95	A17s	0	0	0	0
96	A18s	0	0	0	0
97	A19s	0	0	0	0
98	A16d	0	0	0	0
99	A17d	0	0	0	0
100	A18d	0	0	0	0
101	A19d	0	0	0	0

*** BEAM MEMBER DATA

NO NODAL CONNECTIVITY BEAM END RELEASE MATERIAL SECTION LENGTH

	I	J	I	J			
1	40	4	-	-	fittizio	fittizia	4.886
2	4	20	-	-	fittizio	fittizia	4.885
3	617	409	-	-	C32/40	Pila	5.42
4	618	410	-	-	C32/40	Pila	3.92
75	756	750	-	-	C32/40-antenna	A18s	2.4
77	756	757	-	-	rigido	el rigido	0.85
80	754	755	-	-	S355	tubo219.lx12	1
82	751	753	-	-	S355	tubo219.lx12	1
84	752	755	-	-	rigido	el rigido	1.3
86	750	754	-	-	rigido	el rigido	1.3
87	752	746	-	-	C32/40-antenna	A19d	2.4
89	752	753	-	-	rigido	el rigido	0.85
91	750	744	-	-	C32/40-antenna	A19s	2.4
93	750	751	-	-	rigido	el rigido	0.85
96	748	749	-	-	S355	tubo219.lx12	1
98	745	747	-	-	S355	tubo219.lx12	1
100	746	749	-	-	rigido	el rigido	1.2
102	744	748	-	-	rigido	el rigido	1.2
103	746	709	-	-	C32/40-antenna	A1d	2.4
105	746	747	-	-	rigido	el rigido	0.85
107	744	708	-	-	C32/40-antenna	A1s	2.4
109	744	745	-	-	rigido	el rigido	0.85
110	635	417	-	-	rigido	el rigido	1.53
111	417	636	-	-	rigido	el rigido	1.28
112	742	743	-	-	S355	tubo219.lx12	1
113	636	639	-	-	rigido	el rigido	1
114	730	731	-	-	S355	tubo219.lx12	1
116	738	740	-	-	S355	tubo219.lx12	1
118	726	728	-	-	S355	tubo219.lx12	1
119	739	741	-	-	S355	tubo219.lx12	1
120	708	518	-	-	C32/40-antenna	A2s	0.6
121	727	729	-	-	S355	tubo219.lx12	1
122	709	509	-	-	C32/40-antenna	A2d	0.6
123	736	737	-	-	S355	tubo219.lx12	1
124	710	516	-	-	C32/40-antenna	A4s	0.6
125	724	725	-	-	S355	tubo219.lx12	1
126	711	507	-	-	C32/40-antenna	A4d	0.6
127	712	515	-	-	C32/40-antenna	A6s	0.6001
128	734	735	-	-	S355	tubo219.lx12	1
129	713	506	-	-	C32/40-antenna	A6d	0.6001
130	722	723	-	-	S355	tubo219.lx12	1
131	714	511	-	-	C32/40-antenna	A12s	0.6
132	732	733	-	-	S355	tubo219.lx12	1
133	720	721	-	-	S355	tubo219.lx12	1
134	715	513	-	-	C32/40-antenna	A9s	0.6
135	719	743	-	-	rigido	el rigido	0.6
136	716	502	-	-	C32/40-antenna	A12d	0.6
137	718	742	-	-	rigido	el rigido	0.6
138	717	504	-	-	C32/40-antenna	A9d	0.6
139	717	741	-	-	rigido	el rigido	0.8
140	718	521	-	-	C32/40-antenna	A15s	0.6998
141	716	740	-	-	rigido	el rigido	0.7
142	719	529	-	-	C32/40-antenna	A15d	0.6998
143	715	739	-	-	rigido	el rigido	0.8
144	708	720	-	-	rigido	el rigido	0.85
145	709	721	-	-	rigido	el rigido	0.85
146	714	738	-	-	rigido	el rigido	0.7
147	710	722	-	-	rigido	el rigido	0.85
148	713	737	-	-	rigido	el rigido	0.9
149	712	736	-	-	rigido	el rigido	0.9
150	711	723	-	-	rigido	el rigido	0.85
151	711	735	-	-	rigido	el rigido	1
152	712	724	-	-	rigido	el rigido	0.85
153	710	734	-	-	rigido	el rigido	1
154	713	725	-	-	rigido	el rigido	0.85
155	709	733	-	-	rigido	el rigido	1.1
156	714	726	-	-	rigido	el rigido	0.85
157	708	732	-	-	rigido	el rigido	1.1
158	716	728	-	-	rigido	el rigido	0.85
159	715	727	-	-	rigido	el rigido	0.85
160	719	731	-	-	rigido	el rigido	0.85
161	718	730	-	-	rigido	el rigido	0.85
162	717	729	-	-	rigido	el rigido	0.85
234	346	229	-	-	rigido	traversi	1.8
235	347	230	-	-	rigido	traversi	1.8
236	348	231	-	-	rigido	traversi	1.8
237	349	232	-	-	rigido	traversi	1.8
238	350	233	-	-	rigido	traversi	1.8
239	351	234	-	-	rigido	traversi	1.8
240	352	235	-	-	rigido	traversi	1.8
241	353	236	-	-	rigido	traversi	1.8
242	354	237	-	-	rigido	traversi	1.8
243	355	238	-	-	rigido	traversi	1.8
244	356	239	-	-	rigido	traversi	1.8
245	357	240	-	-	rigido	traversi	1.8
246	358	241	-	-	rigido	traversi	1.8
247	359	242	-	-	rigido	traversi	1.8
248	360	243	-	-	rigido	traversi	1.8
249	361	244	-	-	rigido	traversi	1.8
250	362	245	-	-	rigido	traversi	1.8
251	363	246	-	-	rigido	traversi	1.8
254	366	2	-	-	rigido	traversi	0.8088
255	367	24	-	-	rigido	traversi	0.8126
256	368	3	-	-	rigido	traversi	0.8093
257	369	5	-	-	rigido	traversi	0.8099
258	370	7	-	-	rigido	traversi	0.8115
259	371	9	-	-	rigido	traversi	0.8097
260	372	11	-	-	rigido	traversi	0.8075

Sovrapasso di ingresso - Ponte strallato - Relazione di calcolo

261	373	13	-	-	rigido	traversi	0.8084
262	374	15	-	-	rigido	traversi	0.8092
263	375	17	-	-	rigido	traversi	0.8134
264	376	19	-	-	rigido	traversi	0.8077
265	377	21	-	-	rigido	traversi	0.8088
266	378	25	-	-	rigido	traversi	0.8099
267	379	27	-	-	rigido	traversi	0.8115
268	380	29	-	-	rigido	traversi	0.8097
269	381	31	-	-	rigido	traversi	0.8075
270	382	33	-	-	rigido	traversi	0.8084
271	383	35	-	-	rigido	traversi	0.8092
272	384	37	-	-	rigido	traversi	0.8134
273	385	39	-	-	rigido	traversi	0.8077
274	386	41	-	-	rigido	traversi	0.8088
404	395	401	-	-	C35/45	baggiolo	0.3
405	396	402	-	-	C35/45	baggiolo	0.3
406	397	403	-	-	C35/45	baggiolo	0.3
407	398	404	-	-	C35/45	baggiolo	0.3
408	399	405	-	-	C35/45	baggiolo	0.3
409	400	406	-	-	C35/45	baggiolo	0.3
410	393	185	-	-	rigido	el rigido	1.004
411	391	225	-	-	rigido	el rigido	0.6739
412	394	186	-	-	rigido	el rigido	1.004
413	389	205	-	-	rigido	el rigido	0.6739
414	390	224	-	-	rigido	el rigido	0.6739
415	392	184	-	-	rigido	el rigido	1.004
416	403	407	-	-	rigido	el rigido	2.837
417	402	408	-	-	rigido	el rigido	2.831
418	407	405	-	-	rigido	el rigido	2.832
419	408	404	-	-	rigido	el rigido	2.838
420	407	772	-	-	rigido	Pila	1.05
421	408	773	-	-	rigido	Pila	1.05
500	184	1241	-	-	rigido	traversi	0.6
501	44	205	-	-	rigido	traversi	3.351
502	45	369	-	-	rigido	traversi	4.35
503	46	370	-	-	rigido	traversi	4.35
504	47	371	-	-	rigido	traversi	4.35
505	49	373	-	-	rigido	traversi	4.35
506	50	374	-	-	rigido	traversi	4.35
507	51	375	-	-	rigido	traversi	4.35
508	52	376	-	-	rigido	traversi	4.35
509	53	377	-	-	rigido	traversi	4.35
510	185	1244	-	-	rigido	traversi	0.6
511	55	378	-	-	rigido	traversi	4.35
512	57	380	-	-	rigido	traversi	4.35
513	58	381	-	-	rigido	traversi	4.35
514	59	382	-	-	rigido	traversi	4.35
515	60	383	-	-	rigido	traversi	4.35
516	61	384	-	-	rigido	traversi	4.35
517	62	385	-	-	rigido	traversi	4.35
518	63	386	-	-	rigido	traversi	4.35
519	44	186	-	-	rigido	traversi	2.149
520	45	346	-	-	rigido	traversi	2.15
521	46	347	-	-	rigido	traversi	2.15
522	47	348	-	-	rigido	traversi	2.15
523	48	349	-	-	rigido	traversi	2.15
524	49	350	-	-	rigido	traversi	2.15
525	50	351	-	-	rigido	traversi	2.15
526	52	353	-	-	rigido	traversi	2.15
527	53	354	-	-	rigido	traversi	2.15
528	225	367	-	-	rigido	traversi	0.9989
529	55	355	-	-	rigido	traversi	2.15
530	56	356	-	-	rigido	traversi	2.15
531	57	357	-	-	rigido	traversi	2.15
532	58	358	-	-	rigido	traversi	2.15
533	60	360	-	-	rigido	traversi	2.15
534	61	361	-	-	rigido	traversi	2.15
535	62	362	-	-	rigido	traversi	2.15
536	63	363	-	-	rigido	traversi	2.15
537	43	184	-	-	rigido	traversi	2.149
538	54	185	-	-	rigido	traversi	2.149
539	186	1247	-	-	rigido	traversi	0.6
555	205	368	-	-	rigido	traversi	0.9989
559	48	372	-	-	rigido	traversi	4.35
568	43	224	-	-	rigido	traversi	3.351
569	226	1	-	-	rigido	traversi	0.6008
570	229	6	-	-	rigido	traversi	0.6019
571	231	10	-	-	rigido	traversi	0.6017
572	233	14	-	-	rigido	traversi	0.6004
573	235	18	-	-	rigido	traversi	0.6054
574	236	20	-	-	rigido	traversi	0.5997
575	240	30	-	-	rigido	traversi	0.6017
576	242	34	-	-	rigido	traversi	0.6004
577	245	40	-	-	rigido	traversi	0.5997
628	246	42	-	-	rigido	traversi	0.6008
629	244	38	-	-	rigido	traversi	0.6054
630	243	36	-	-	rigido	traversi	0.6012
631	239	28	-	-	rigido	traversi	0.6035
632	237	22	-	-	rigido	traversi	0.6008
633	234	16	-	-	rigido	traversi	0.6012
634	232	12	-	-	rigido	traversi	0.5995
635	230	8	-	-	rigido	traversi	0.6035
636	228	4	-	-	rigido	traversi	0.6013
637	227	23	-	-	rigido	traversi	0.6046
641	56	379	-	-	rigido	traversi	4.35
658	227	246	-	-	S355	tubo	4.89
659	226	237	-	-	S355	tubo	4.881
674	246	238	-	-	S355	tubo	4.831
675	238	242	-	-	S355	tubo	4.841
676	242	1237	-	-	S355	tubo	2.418

Sovrapasso di ingresso - Ponte strallato - Relazione di calcolo

677	239	243	-	-	S355	tubo	4.845
678	243	240	-	-	S355	tubo	4.838
679	240	244	000011	000000	S355	tubo	4.839
680	244	241	-	-	S355	tubo	4.833
681	241	1238	-	-	S355	tubo	2.421
682	245	228	-	-	S355	tubo	4.836
683	228	236	-	-	S355	tubo	4.835
684	236	1239	-	-	S355	tubo	2.419
685	232	235	-	-	S355	tubo	4.828
686	235	231	000000	000011	S355	tubo	4.833
687	231	234	-	-	S355	tubo	4.831
688	234	230	-	-	S355	tubo	4.838
689	230	1240	-	-	S355	tubo	2.415
690	233	229	-	-	S355	tubo	4.836
691	229	237	-	-	S355	tubo	4.826
838	519	762	-	-	C32/40-antenna	A16s	2
840	510	718	-	-	C32/40-antenna	A14s	0.6
841	511	510	-	-	C32/40-antenna	A13s	1.2
842	512	714	-	-	C32/40-antenna	A11s	0.6
843	513	512	-	-	C32/40-antenna	A10s	1.2
844	514	715	-	-	C32/40-antenna	A8s	0.6
845	515	514	-	-	C32/40-antenna	A7s	1.2
846	516	712	-	-	C32/40-antenna	A5s	1.8
847	518	710	-	-	C32/40-antenna	A3s	1.8
854	527	764	-	-	C32/40-antenna	A16d	2
856	501	719	-	-	C32/40-antenna	A14d	0.6
857	502	501	-	-	C32/40-antenna	A13d	1.2
858	503	716	-	-	C32/40-antenna	A11d	0.6
859	504	503	-	-	C32/40-antenna	A10d	1.2
860	505	717	-	-	C32/40-antenna	A8d	0.6
861	506	505	-	-	C32/40-antenna	A7d	1.2
862	507	713	-	-	C32/40-antenna	A5d	1.8
863	509	711	-	-	C32/40-antenna	A3d	1.8
883	519	417	-	-	rigido	el rigido	0.5831
884	417	527	-	-	rigido	el rigido	0.5831
962	224	366	-	-	rigido	traversi	0.9989
963	51	352	-	-	rigido	traversi	2.15
964	59	359	-	-	rigido	traversi	2.15
970	238	26	-	-	rigido	traversi	0.6019
978	241	32	-	-	rigido	traversi	0.5995
979	54	225	-	-	rigido	traversi	3.351
980	23	42	-	-	fittizio	fittizia	4.948
981	42	26	-	-	fittizio	fittizia	4.881
982	26	34	-	-	fittizio	fittizia	4.892
983	34	28	-	-	fittizio	fittizia	4.888
984	28	36	-	-	fittizio	fittizia	4.896
985	36	30	-	-	fittizio	fittizia	4.888
986	30	38	-	-	fittizio	fittizia	4.89
987	38	32	-	-	fittizio	fittizia	4.884
988	32	40	-	-	fittizio	fittizia	4.893
991	20	12	-	-	fittizio	fittizia	4.889
992	12	18	-	-	fittizio	fittizia	4.878
993	18	10	-	-	fittizio	fittizia	4.884
994	10	16	-	-	fittizio	fittizia	4.881
995	16	8	-	-	fittizio	fittizia	4.89
996	8	14	-	-	fittizio	fittizia	4.882
997	14	6	-	-	fittizio	fittizia	4.886
998	6	22	-	-	fittizio	fittizia	4.877
999	22	1	-	-	fittizio	fittizia	4.938
1000	387	54	-	-	S355	Impalcato 30-3-	0.5
1001	54	124	-	-	S355	Impalcato 30-3-	0.6455
1002	124	125	-	-	S355	Impalcato 30-3-	0.6485
1003	125	126	-	-	S355	Impalcato 30-3-	0.5578
1004	126	597	-	-	S355	f-Impalcato 30-	0.404
1005	597	127	-	-	S355	f-Impalcato 30-	0.404
1006	127	128	-	-	S355	Impalcato 30-3-	0.5644
1007	128	129	-	-	S355	Impalcato 30-3-	0.6409
1008	129	63	-	-	S355	Impalcato 30-3-	0.6482
1009	63	130	-	-	S355	Impalcato 30-3-	0.6413
1010	130	131	-	-	S355	Impalcato 30-3-	0.6452
1011	131	132	-	-	S355	Impalcato 30-3-	0.5655
1012	132	598	-	-	S355	f-Impalcato 30-	0.4013
1013	598	133	-	-	S355	f-Impalcato 30-	0.4013
1014	133	134	-	-	S355	Impalcato 30-3-	0.5593
1015	134	135	-	-	S355	Impalcato 30-3-	0.6508
1016	135	55	-	-	S355	Impalcato 30-3-	0.6374
1017	55	136	-	-	S355	Impalcato 30-3-	0.6492
1018	136	137	-	-	S355	Impalcato 30-3-	0.6461
1019	137	138	-	-	S355	Impalcato 30-3-	0.56
1020	138	599	-	-	S355	f-Impalcato 30-	0.4025
1021	599	139	-	-	S355	f-Impalcato 30-	0.4025
1022	139	140	-	-	S355	Impalcato 30-3-	0.5621
1023	140	141	-	-	S355	Impalcato 30-3-	0.6473
1024	141	59	-	-	S355	Impalcato 30-3-	0.6416
1025	59	142	-	-	S355	Impalcato 30-3-	0.6432
1026	142	143	-	-	S355	Impalcato 30-3-	0.6419
1027	143	144	-	-	S355	Impalcato 30-3-	0.5661
1028	144	600	-	-	S355	f-Impalcato 30-	0.4012
1029	600	145	-	-	S355	f-Impalcato 30-	0.4012
1030	145	146	-	-	S355	Impalcato 30-3-	0.5693
1031	146	147	-	-	S355	Impalcato 30-3-	0.6416
1032	147	56	-	-	S355	Impalcato 30-3-	0.641
1033	56	148	-	-	S355	Impalcato 30-3-	0.6456
1034	148	149	-	-	S355	Impalcato 30-3-	0.6475
1035	149	150	-	-	S355	Impalcato 30-3-	0.5629
1036	150	601	-	-	S355	f-Impalcato 30-	0.4014
1037	601	151	-	-	S355	f-Impalcato 30-	0.4014
1038	151	152	-	-	S355	Impalcato 30-3-	0.5672
1039	152	153	-	-	S355	Impalcato 30-3-	0.6407
1040	153	60	-	-	S355	Impalcato 30-3-	0.6432

Sovrapasso di ingresso - Ponte strallato - Relazione di calcolo

1041	60	154	-	-	S355 Impalcato 30-3-	0.6433
1042	154	155	-	-	S355 Impalcato 30-3-	0.6464
1043	155	156	-	-	S355 Impalcato 30-3-	0.5645
1044	156	602	-	-	S355 f-Impalcato 30-	0.4036
1045	602	157	-	-	S355 f-Impalcato 30-	0.4036
1046	157	158	-	-	S355 Impalcato 30-3-	0.5589
1047	158	159	-	-	S355 Impalcato 30-3-	0.6465
1048	159	57	-	-	S355 Impalcato 30-3-	0.643
1049	57	160	000011	000000	S355 Impalcato 30-3-	0.6462
1050	160	161	-	-	S355 Impalcato 30-3-	0.643
1051	161	162	-	-	S355 Impalcato 30-3-	0.563
1052	162	603	-	-	S355 f-Impalcato 30-	0.4016
1053	603	163	-	-	S355 f-Impalcato 30-	0.4016
1054	163	164	-	-	S355 Impalcato 30-3-	0.5666
1055	164	165	-	-	S355 Impalcato 30-3-	0.6452
1056	165	61	-	-	S355 Impalcato 30-3-	0.6412
1057	61	166	-	-	S355 Impalcato 30-3-	0.6414
1058	166	167	-	-	S355 Impalcato 30-3-	0.6475
1059	167	168	-	-	S355 Impalcato 30-3-	0.5626
1060	168	604	-	-	S355 f-Impalcato 30-	0.4026
1061	604	169	-	-	S355 f-Impalcato 30-	0.4026
1062	169	170	-	-	S355 Impalcato 30-3-	0.5642
1063	170	171	-	-	S355 Impalcato 30-3-	0.6422
1064	171	58	-	-	S355 Impalcato 30-3-	0.6404
1065	58	172	-	-	S355 Impalcato 30-3-	0.6485
1066	172	173	-	-	S355 Impalcato 30-3-	0.6436
1067	173	174	-	-	S355 Impalcato 30-3-	0.5671
1068	174	605	-	-	S355 f-Impalcato 30-	0.4004
1069	605	175	-	-	S355 f-Impalcato 30-	0.4004
1070	175	176	-	-	S355 Impalcato 30-3-	0.5651
1071	176	177	-	-	S355 Impalcato 30-3-	0.644
1072	177	62	-	-	S355 Impalcato 30-3-	0.643
1073	62	178	-	-	S355 Impalcato 30-3-	0.6429
1074	178	179	-	-	S355 Impalcato 30-3-	0.6465
1075	179	180	-	-	S355 Impalcato 30-3-	0.5615
1076	180	606	-	-	S355 f-Impalcato 30-	0.4031
1077	606	181	-	-	S355 f-Impalcato 30-	0.4031
1078	181	182	-	-	S355 Impalcato 30-3-	0.5608
1079	182	183	-	-	S355 Impalcato 30-3-	0.6407
1080	183	44	-	-	S355 Impalcato 30-3-	0.6454
1081	44	123	-	-	S355 Impalcato 30-3-	0.6454
1082	123	122	-	-	S355 Impalcato 30-3-	0.6405
1083	122	121	-	-	S355 Impalcato 30-3-	0.5607
1084	121	607	-	-	S355 f-Impalcato 30-	0.403
1085	607	120	-	-	S355 f-Impalcato 30-	0.403
1086	120	119	-	-	S355 Impalcato 30-3-	0.5613
1087	119	118	-	-	S355 Impalcato 30-3-	0.6463
1088	118	52	-	-	S355 Impalcato 30-3-	0.6426
1089	52	117	-	-	S355 Impalcato 30-3-	0.6426
1090	117	116	-	-	S355 Impalcato 30-3-	0.6435
1091	116	115	-	-	S355 Impalcato 30-3-	0.5646
1092	115	608	-	-	S355 f-Impalcato 30-	0.4001
1093	608	114	-	-	S355 f-Impalcato 30-	0.4001
1094	114	113	-	-	S355 Impalcato 30-3-	0.5665
1095	113	112	-	-	S355 Impalcato 30-3-	0.643
1096	112	48	-	-	S355 Impalcato 30-3-	0.6479
1097	48	111	-	-	S355 Impalcato 30-3-	0.6396
1098	111	110	-	-	S355 Impalcato 30-3-	0.6414
1099	110	109	-	-	S355 Impalcato 30-3-	0.5634
1100	109	609	-	-	S355 f-Impalcato 30-	0.4022
1101	609	108	-	-	S355 f-Impalcato 30-	0.4022
1102	108	107	-	-	S355 Impalcato 30-3-	0.5617
1103	107	106	-	-	S355 Impalcato 30-3-	0.6466
1104	106	51	-	-	S355 Impalcato 30-3-	0.6404
1105	51	105	-	-	S355 Impalcato 30-3-	0.6404
1106	105	104	-	-	S355 Impalcato 30-3-	0.6443
1107	104	103	-	-	S355 Impalcato 30-3-	0.5656
1108	103	610	-	-	S355 f-Impalcato 30-	0.4011
1109	610	102	-	-	S355 f-Impalcato 30-	0.4011
1110	102	101	-	-	S355 Impalcato 30-3-	0.562
1111	101	100	-	-	S355 Impalcato 30-3-	0.642
1112	100	47	000000	000011	S355 Impalcato 30-3-	0.6451
1113	47	99	-	-	S355 Impalcato 30-3-	0.6421
1114	99	98	-	-	S355 Impalcato 30-3-	0.6455
1115	98	97	-	-	S355 Impalcato 30-3-	0.5579
1116	97	611	-	-	S355 f-Impalcato 30-	0.4031
1117	611	96	-	-	S355 f-Impalcato 30-	0.4031
1118	96	95	-	-	S355 Impalcato 30-3-	0.5635
1119	95	94	-	-	S355 Impalcato 30-3-	0.6454
1120	94	50	-	-	S355 Impalcato 30-3-	0.6422
1121	50	93	-	-	S355 Impalcato 30-3-	0.6377
1122	93	92	-	-	S355 Impalcato 30-3-	0.6443
1123	92	91	-	-	S355 Impalcato 30-3-	0.5663
1124	91	612	-	-	S355 f-Impalcato 30-	0.4009
1125	612	90	-	-	S355 f-Impalcato 30-	0.4009
1126	90	89	-	-	S355 Impalcato 30-3-	0.5618
1127	89	88	-	-	S355 Impalcato 30-3-	0.6465
1128	88	46	-	-	S355 Impalcato 30-3-	0.6445
1129	46	87	-	-	S355 Impalcato 30-3-	0.6401
1130	87	86	-	-	S355 Impalcato 30-3-	0.6407
1131	86	85	-	-	S355 Impalcato 30-3-	0.5683
1132	85	613	-	-	S355 f-Impalcato 30-	0.4007
1133	613	84	-	-	S355 f-Impalcato 30-	0.4007
1134	84	83	-	-	S355 Impalcato 30-3-	0.5651
1135	83	82	-	-	S355 Impalcato 30-3-	0.6409
1136	82	49	-	-	S355 Impalcato 30-3-	0.6422
1137	49	81	-	-	S355 Impalcato 30-3-	0.6408
1138	81	80	-	-	S355 Impalcato 30-3-	0.6465
1139	80	79	-	-	S355 Impalcato 30-3-	0.5613
1140	79	614	-	-	S355 f-Impalcato 30-	0.4021

Sovrapasso di ingresso - Ponte strallato - Relazione di calcolo

1141	614	78	-	-	S355	f-Impalcato 30-	0.4021
1142	78	77	-	-	S355	Impalcato 30-3-	0.5592
1143	77	76	-	-	S355	Impalcato 30-3-	0.6453
1144	76	45	-	-	S355	Impalcato 30-3-	0.6483
1145	45	75	-	-	S355	Impalcato 30-3-	0.6367
1146	75	74	-	-	S355	Impalcato 30-3-	0.6501
1147	74	73	-	-	S355	Impalcato 30-3-	0.5586
1148	73	615	-	-	S355	f-Impalcato 30-	0.4009
1149	615	72	-	-	S355	f-Impalcato 30-	0.4009
1150	72	71	-	-	S355	Impalcato 30-3-	0.5648
1151	71	70	-	-	S355	Impalcato 30-3-	0.6444
1152	70	53	-	-	S355	Impalcato 30-3-	0.6405
1153	53	69	-	-	S355	Impalcato 30-3-	0.6476
1154	69	68	-	-	S355	Impalcato 30-3-	0.6404
1155	68	67	-	-	S355	Impalcato 30-3-	0.5639
1156	67	616	-	-	S355	f-Impalcato 30-	0.4038
1157	616	66	-	-	S355	f-Impalcato 30-	0.4038
1158	66	65	-	-	S355	Impalcato 30-3-	0.5572
1159	65	64	-	-	S355	Impalcato 30-3-	0.648
1160	64	43	-	-	S355	Impalcato 30-3-	0.6416
1161	43	388	-	-	S355	Impalcato 30-3-	0.5
1162	758	759	-	-		rigido el rigido	0.85
1163	758	752	-	-	C32/40-antenna	A18d	2.4
1164	756	760	-	-		rigido el rigido	1.4
1165	758	761	-	-		rigido el rigido	1.4
1166	757	759	-	-	S355	tubo219.1x12	1
1167	760	761	-	-	S355	tubo219.1x12	1
1168	762	763	-	-		rigido el rigido	0.85
1169	762	756	-	-	C32/40-antenna	A17s	2.4
1170	764	765	-	-		rigido el rigido	0.85
1171	764	758	-	-	C32/40-antenna	A17d	2.4
1172	762	766	-	-		rigido el rigido	1.5
1173	764	767	-	-		rigido el rigido	1.5
1174	765	757	000111	000011	S355	2UPN220	2.6
1177	757	753	000111	000011	S355	2UPN220	2.6
1178	753	745	000111	000011	S355	2UPN220	2.6
1181	745	721	000111	000011	S355	2UPN220	2.6
1182	721	722	000111	000011	S355	2UPN220	2.6
1185	722	725	000111	000011	S355	2UPN220	2.6
1186	725	727	000111	000011	S355	2UPN220	2.6
1189	727	728	000111	000011	S355	2UPN220	2.6
1190	728	730	000111	000011	S355	2UPN220	2.6
1193	766	761	000111	000011	S355	2UPN220	2.562
1194	761	754	000111	000011	S355	2UPN220	2.562
1197	754	749	000111	000011	S355	2UPN220	2.562
1198	749	732	000111	000011	S355	2UPN220	2.562
1201	732	735	000111	000011	S355	2UPN220	2.562
1202	735	736	000111	000011	S355	2UPN220	2.562
1205	736	741	000111	000011	S355	2UPN220	2.562
1206	741	738	000111	000011	S355	2UPN220	2.562
1209	738	743	000111	000011	S355	2UPN220	2.563
1210	763	765	-	-	S355	tubo219.1x12	1
1211	766	767	-	-	S355	tubo219.1x12	1
1212	519	768	-	-		rigido el rigido	0.8495
1213	527	769	-	-		rigido el rigido	0.8495
1214	519	770	-	-		rigido el rigido	1.58
1215	527	771	-	-		rigido el rigido	1.58
1216	769	768	-	-		rigido el rigido	1
1217	771	770	-	-		rigido el rigido	1
1219	768	765	000111	000011	S355	2UPN220	2.236
1221	771	766	000111	000011	S355	2UPN220	2.207
1222	772	617	-	-		rigido Pila	1.13
1223	773	618	-	-		rigido Pila	1.13
1224	619	620	-	-		fittizio fittizia	0.7203
1225	620	621	-	-		fittizio fittizia	0.9578
1226	621	622	-	-		fittizio fittizia	1.128
1227	622	624	-	-		fittizio fittizia	0.85
1228	624	625	-	-		fittizio fittizia	1.042
1229	625	626	-	-		fittizio fittizia	1.051
1230	626	627	-	-		fittizio fittizia	1.043
1231	627	628	-	-		fittizio fittizia	1.047
1232	628	629	-	-		fittizio fittizia	1.051
1661	1237	239	-	-	S355	tubo	2.418
1662	1238	245	-	-	S355	tubo	2.421
1663	1239	232	-	-	S355	tubo	2.419
1664	1240	233	-	-	S355	tubo	2.415
1709	1241	226	-	-		rigido traversi	1.201
1711	1242	1243	-	-		rigido el rigido	0.4899
1712	404	1242	-	-		rigido el rigido	0.5989
1713	1244	227	-	-		rigido traversi	1.201
1715	1245	1246	-	-		rigido el rigido	0.4899
1716	405	1245	-	-		rigido el rigido	0.5991
1717	1247	228	-	-		rigido traversi	1.201
1719	635	1248	-	-		rigido el rigido	1.101
1720	1248	406	-	-		rigido el rigido	0.5989
1721	1248	1249	-	-		rigido el rigido	0.49

*** TRUSS MEMBER DATA

NO	NODAL CONNECTIVITY		MATERIAL	SECTION	TENSION / COMPRESSION	SECTION AREA		LENGTH
	I	J				I	J	
6	241	516	Cavi	31	N	0.00465	-	17.17
7	244	515	Cavi	31	N	0.00465	-	22.47
8	240	514	Cavi	31	N	0.00465	-	27.16
9	243	513	Cavi	31	N	0.00465	-	32.07
10	239	512	Cavi	31	N	0.00465	-	37.12
11	242	511	Cavi	31	N	0.00465	-	42.24
12	238	510	Cavi	31	N	0.00465	-	47.39

Sovrapasso di ingresso - Ponte strallato - Relazione di calcolo

14	232	507	Cavi	31	N	0.00465	-	16.73
15	235	506	Cavi	31	N	0.00465	-	21.86
16	231	505	Cavi	31	N	0.00465	-	26.45
17	234	504	Cavi	31	N	0.00465	-	31.29
18	230	503	Cavi	31	N	0.00465	-	36.29
19	233	502	Cavi	31	N	0.00465	-	41.37
20	229	501	Cavi	31	N	0.00465	-	46.5
1710	1241	1243	FLC48	FLC48	N	0.001551	-	1
1714	1244	1246	FLC48	FLC48	N	0.001551	-	1
1718	1247	1249	FLC48	FLC48	N	0.001551	-	1

*** PLATE MEMBER DATA

NO	NODAL CONNECTIVITY				MATERIAL	THICKNESS	AREA
	1	2	3	4			
21	629	630	649	628	C32/40	1.4	1.206
22	630	699	707	649	C32/40	1.8	1.206
23	699	689	697	707	C32/40	1.8	1.14
24	689	631	657	697	C32/40	1.8	1.615
25	631	632	665	657	C32/40	1.91	1.454
26	632	633	673	665	C32/40	1.91	1.519
27	633	634	681	673	C32/40	1.08	1.19
28	628	649	648	627	C32/40	1.4	1.187
29	649	707	706	648	C32/40	1.8	1.191
30	707	697	696	706	C32/40	1.8	1.128
31	697	657	656	696	C32/40	1.8	1.598
32	657	665	664	656	C32/40	2.14	1.438
33	665	673	672	664	C32/40	2.14	1.463
34	673	681	680	672	C32/40	1.23	1.146
35	627	648	647	626	C32/40	1.4	1.202
36	648	706	705	647	C32/40	1.8	1.202
37	706	696	695	705	C32/40	1.8	1.14
38	696	656	655	695	C32/40	1.8	1.615
39	656	664	663	655	C32/40	2.36	1.454
40	664	672	671	663	C32/40	2.36	1.438
41	672	680	679	671	C32/40	1.38	1.126
42	626	647	646	625	C32/40	1.4	1.211
43	647	705	704	646	C32/40	1.8	1.2
44	705	695	694	704	C32/40	1.8	1.14
45	695	655	654	694	C32/40	1.8	1.615
46	655	663	662	654	C32/40	2.59	1.454
47	663	671	670	662	C32/40	2.59	1.397
48	671	679	678	670	C32/40	1.53	1.094
49	625	646	623	624	C32/40	1.4	1.196
50	646	704	700	623	C32/40	1.8	1.186
51	704	694	690	700	C32/40	1.8	1.128
52	694	654	650	690	C32/40	1.8	1.598
53	654	662	658	650	C32/40	2.82	1.438
54	662	670	666	658	C32/40	2.82	1.342
55	670	678	674	666	C32/40	1.68	1.051
57	623	700	703	645	C32/40	1.87	0.9697
58	700	690	693	703	C32/40	1.87	0.924
59	690	650	653	693	C32/40	1.87	1.309
60	650	658	661	653	C32/40	3.02	1.178
61	658	666	669	661	C32/40	3.02	1.07
62	666	674	677	669	C32/40	1.8	0.8371
63	622	645	644	687	C32/40	2.01	0.9305
64	645	703	702	644	C32/40	2.01	0.9182
65	703	693	692	702	C32/40	2.01	0.876
66	693	653	652	692	C32/40	2.01	1.241
67	653	661	660	652	C32/40	3.2	1.117
68	661	669	668	660	C32/40	3.2	0.9898
69	669	677	676	668	C32/40	1.93	0.774
70	687	644	643	688	C32/40	2.14	0.7903
71	644	702	701	643	C32/40	2.14	0.779
72	702	692	691	701	C32/40	2.14	0.744
73	692	652	651	691	C32/40	2.14	1.054
74	652	660	659	651	C32/40	3.36	0.9486
76	660	668	667	659	C32/40	3.36	0.8218
78	668	676	675	667	C32/40	2.04	0.6424
79	688	643	642	682	C32/40	2.2	0.8923
81	643	701	698	642	C32/40	2.2	0.8789
83	701	691	406	698	C32/40	2.2	0.8406
85	691	651	635	406	C32/40	2.2	1.191
88	651	659	417	635	C32/40	3.52	1.072
90	659	667	636	417	C32/40	3.52	0.9076
92	667	675	639	636	C32/40	2.14	0.7092
94	621	685	686	683	C32/40	2.14	0.523
95	685	687	688	686	C32/40	2.14	0.3054
97	683	686	684	401	C32/40	2.2	0.566
99	686	688	682	684	C32/40	2.2	0.5636
101	620	683	401	619	C32/40	2.2	0.4875
104	622	687	685	0	C32/40	2.01	0.1262
106	622	685	621	0	C32/40	2.01	0.3139
108	621	683	620	0	C32/40	2.14	0.2365
115	624	623	622	0	C32/40	1.4	0.489
117	623	645	622	0	C32/40	1.87	0.4907
1233	774	823	809	838	C28/35	2	0.64
1234	838	809	1182	1181	C28/35	2	0.524
1235	841	825	1168	1167	C28/35	2	0.436
1236	837	802	950	949	C28/35	2	0.384
1237	836	801	1134	1133	C28/35	2	0.48
1238	839	813	1136	1135	C28/35	2	0.48
1239	835	794	1120	1119	C28/35	2	0.332
1240	840	824	1092	1091	C28/35	2	0.4187
1241	834	793	958	957	C28/35	2	0.384
1242	833	786	818	777	C28/35	2	0.64
1254	800	852	1138	1137	C28/35	2	0.18

Sovrapasso di ingresso - Ponte strallato - Relazione di calcolo

1255	812	851	1140	1139	C28/35	2	0.18
1258	852	828	1141	1138	C28/35	2	0.54
1259	828	856	1142	1141	C28/35	2	0.54
1260	851	500	1143	1140	C28/35	2	0.54
1261	500	855	1144	1143	C28/35	2	0.54
1262	853	829	1210	1209	C28/35	2	0.3735
1263	829	857	1211	1210	C28/35	2	0.3735
1267	856	799	1145	1142	C28/35	2	0.18
1268	855	811	1146	1144	C28/35	2	0.18
1279	786	861	865	818	C28/35	2	0.384
1280	787	1077	1078	817	C28/35	2	0.48
1281	860	1079	1080	814	C28/35	2	0.48
1282	788	869	873	816	C28/35	2	0.384
1283	789	842	776	815	C28/35	2	0.64
1284	823	877	881	809	C28/35	2	0.384
1285	809	881	1183	1182	C28/35	2	0.3242
1286	825	885	1169	1168	C28/35	2	0.2861
1287	802	889	985	950	C28/35	2	0.2304
1288	801	893	1147	1134	C28/35	2	0.288
1289	813	897	1148	1136	C28/35	2	0.288
1290	794	901	1121	1120	C28/35	2	0.2054
1291	824	905	1095	1092	C28/35	2	0.2774
1292	793	909	989	958	C28/35	2	0.2304
1293	792	1081	1082	993	C28/35	2	0.288
1294	859	1083	1084	994	C28/35	2	0.288
1295	791	913	1005	1001	C28/35	2	0.2304
1296	790	843	1010	1009	C28/35	2	0.384
1297	820	775	847	806	C28/35	2	0.64
1298	806	847	1185	1184	C28/35	2	0.524
1299	827	850	1171	1170	C28/35	2	0.436
1300	805	846	1018	1017	C28/35	2	0.384
1301	798	845	1150	1149	C28/35	2	0.48
1302	810	848	1152	1151	C28/35	2	0.48
1303	797	844	1123	1122	C28/35	2	0.332
1304	826	849	1098	1097	C28/35	2	0.4187
1305	821	917	921	807	C28/35	2	0.384
1306	807	921	1187	1186	C28/35	2	0.3242
1308	804	929	1025	981	C28/35	2	0.2304
1309	799	933	1153	1145	C28/35	2	0.288
1310	811	937	1154	1146	C28/35	2	0.288
1311	796	941	1125	1124	C28/35	2	0.2054
1312	780	945	1102	1101	C28/35	2	0.2774
1313	861	862	866	865	C28/35	2	0.384
1314	862	863	867	866	C28/35	2	0.384
1315	863	864	868	867	C28/35	2	0.384
1316	864	787	817	868	C28/35	2	0.384
1317	869	870	874	873	C28/35	2	0.384
1318	870	871	875	874	C28/35	2	0.384
1319	871	872	876	875	C28/35	2	0.384
1320	872	789	815	876	C28/35	2	0.384
1321	877	878	882	881	C28/35	2	0.384
1322	878	879	883	882	C28/35	2	0.384
1323	879	880	884	883	C28/35	2	0.384
1324	880	822	808	884	C28/35	2	0.384
1325	881	882	1188	1183	C28/35	2	0.3242
1326	882	883	1189	1188	C28/35	2	0.3242
1327	883	884	1190	1189	C28/35	2	0.3242
1328	884	808	1191	1190	C28/35	2	0.3242
1329	885	886	1174	1169	C28/35	2	0.2861
1330	886	887	1175	1174	C28/35	2	0.2861
1331	887	888	1176	1175	C28/35	2	0.2861
1333	889	890	1029	985	C28/35	2	0.2304
1334	890	891	1033	1029	C28/35	2	0.2304
1335	891	892	1037	1033	C28/35	2	0.2304
1336	892	803	965	1037	C28/35	2	0.2304
1337	893	894	1155	1147	C28/35	2	0.288
1338	894	895	1156	1155	C28/35	2	0.288
1339	895	896	1157	1156	C28/35	2	0.288
1340	896	800	1137	1157	C28/35	2	0.288
1341	897	898	1158	1148	C28/35	2	0.288
1342	898	899	1159	1158	C28/35	2	0.288
1343	899	900	1160	1159	C28/35	2	0.288
1344	900	812	1139	1160	C28/35	2	0.288
1345	901	902	1126	1121	C28/35	2	0.2054
1346	902	903	1127	1126	C28/35	2	0.2054
1347	903	904	1128	1127	C28/35	2	0.2054
1348	904	795	1129	1128	C28/35	2	0.2054
1349	905	906	1105	1095	C28/35	2	0.2774
1350	906	907	1107	1105	C28/35	2	0.2774
1351	907	908	1109	1107	C28/35	2	0.2774
1352	908	781	1111	1109	C28/35	2	0.2774
1353	909	910	1041	989	C28/35	2	0.2304
1354	910	911	1045	1041	C28/35	2	0.2304
1355	911	912	1049	1045	C28/35	2	0.2304
1356	912	792	993	1049	C28/35	2	0.2304
1357	913	914	1053	1005	C28/35	2	0.2304
1358	914	915	1057	1053	C28/35	2	0.2304
1359	915	916	1061	1057	C28/35	2	0.2304
1360	916	790	1009	1061	C28/35	2	0.2304
1361	917	918	922	921	C28/35	2	0.384
1362	918	919	923	922	C28/35	2	0.384
1363	919	920	924	923	C28/35	2	0.384
1364	920	820	806	924	C28/35	2	0.384
1365	921	922	1192	1187	C28/35	2	0.3242
1366	922	923	1193	1192	C28/35	2	0.3242
1367	923	924	1194	1193	C28/35	2	0.3242
1368	924	806	1184	1194	C28/35	2	0.3242
1369	925	926	1178	1173	C28/35	2	0.2861
1370	926	927	1179	1178	C28/35	2	0.2861
1371	927	928	1180	1179	C28/35	2	0.2861

Sovrapasso di ingresso - Ponte strallato - Relazione di calcolo

1372	928	827	1170	1180	C28/35	2	0.2861
1373	929	930	1065	1025	C28/35	2	0.2304
1374	930	931	1069	1065	C28/35	2	0.2304
1375	931	932	1073	1069	C28/35	2	0.2304
1376	932	805	1017	1073	C28/35	2	0.2304
1377	933	934	1161	1153	C28/35	2	0.288
1378	934	935	1162	1161	C28/35	2	0.288
1379	935	936	1163	1162	C28/35	2	0.288
1380	936	798	1149	1163	C28/35	2	0.288
1381	937	938	1164	1154	C28/35	2	0.288
1382	938	939	1165	1164	C28/35	2	0.288
1383	939	940	1166	1165	C28/35	2	0.288
1384	940	810	1151	1166	C28/35	2	0.288
1385	941	942	1130	1125	C28/35	2	0.2054
1386	942	943	1131	1130	C28/35	2	0.2054
1387	943	944	1132	1131	C28/35	2	0.2054
1388	944	797	1122	1132	C28/35	2	0.2054
1389	945	946	1113	1102	C28/35	2	0.2774
1390	946	947	1115	1113	C28/35	2	0.2774
1391	947	948	1117	1115	C28/35	2	0.2774
1392	948	826	1097	1117	C28/35	2	0.2774
1393	949	950	952	951	C28/35	2	0.384
1394	951	952	954	953	C28/35	2	0.384
1395	953	954	956	955	C28/35	2	0.384
1396	955	956	801	836	C28/35	2	0.384
1397	957	958	960	959	C28/35	2	0.384
1398	959	960	962	961	C28/35	2	0.384
1399	961	962	964	963	C28/35	2	0.384
1400	963	964	786	833	C28/35	2	0.384
1404	971	972	852	800	C28/35	2	0.189
1408	972	976	828	852	C28/35	2	0.702
1412	976	980	856	828	C28/35	2	0.702
1416	980	984	799	856	C28/35	2	0.189
1417	950	985	986	952	C28/35	2	0.2304
1418	952	986	987	954	C28/35	2	0.2304
1419	954	987	988	956	C28/35	2	0.2304
1420	956	988	893	801	C28/35	2	0.2304
1421	958	989	990	960	C28/35	2	0.2304
1422	960	990	991	962	C28/35	2	0.2304
1423	962	991	992	964	C28/35	2	0.2304
1424	964	992	861	786	C28/35	2	0.2304
1425	993	1082	1085	995	C28/35	2	0.288
1426	995	1085	1086	997	C28/35	2	0.288
1427	997	1086	1087	999	C28/35	2	0.288
1428	999	1087	1077	787	C28/35	2	0.288
1429	994	1084	1088	996	C28/35	2	0.288
1430	996	1088	1089	998	C28/35	2	0.288
1431	998	1089	1090	1000	C28/35	2	0.288
1432	1000	1090	1079	860	C28/35	2	0.288
1433	1001	1005	1006	1002	C28/35	2	0.2304
1434	1002	1006	1007	1003	C28/35	2	0.2304
1435	1003	1007	1008	1004	C28/35	2	0.2304
1436	1004	1008	869	788	C28/35	2	0.2304
1437	1009	1010	1012	1011	C28/35	2	0.384
1438	1011	1012	1014	1013	C28/35	2	0.384
1439	1013	1014	1016	1015	C28/35	2	0.384
1440	1015	1016	842	789	C28/35	2	0.384
1441	1017	1018	1020	1019	C28/35	2	0.384
1442	1019	1020	1022	1021	C28/35	2	0.384
1443	1021	1022	1024	1023	C28/35	2	0.384
1444	1023	1024	845	798	C28/35	2	0.384
1445	981	1025	1026	982	C28/35	2	0.2304
1446	982	1026	1027	983	C28/35	2	0.2304
1447	983	1027	1028	984	C28/35	2	0.2304
1448	984	1028	933	799	C28/35	2	0.2304
1449	985	1029	1030	986	C28/35	2	0.2304
1450	986	1030	1031	987	C28/35	2	0.2304
1451	987	1031	1032	988	C28/35	2	0.2304
1452	988	1032	894	893	C28/35	2	0.2304
1453	1029	1033	1034	1030	C28/35	2	0.2304
1454	1030	1034	1035	1031	C28/35	2	0.2304
1455	1031	1035	1036	1032	C28/35	2	0.2304
1456	1032	1036	895	894	C28/35	2	0.2304
1457	1033	1037	1038	1034	C28/35	2	0.2304
1458	1034	1038	1039	1035	C28/35	2	0.2304
1459	1035	1039	1040	1036	C28/35	2	0.2304
1460	1036	1040	896	895	C28/35	2	0.2304
1461	1037	965	967	1038	C28/35	2	0.2304
1462	1038	967	969	1039	C28/35	2	0.2304
1463	1039	969	971	1040	C28/35	2	0.2304
1464	1040	971	800	896	C28/35	2	0.2304
1465	989	1041	1042	990	C28/35	2	0.2304
1466	990	1042	1043	991	C28/35	2	0.2304
1467	991	1043	1044	992	C28/35	2	0.2304
1468	992	1044	862	861	C28/35	2	0.2304
1469	1041	1045	1046	1042	C28/35	2	0.2304
1470	1042	1046	1047	1043	C28/35	2	0.2304
1471	1043	1047	1048	1044	C28/35	2	0.2304
1472	1044	1048	863	862	C28/35	2	0.2304
1473	1045	1049	1050	1046	C28/35	2	0.2304
1474	1046	1050	1051	1047	C28/35	2	0.2304
1475	1047	1051	1052	1048	C28/35	2	0.2304
1476	1048	1052	864	863	C28/35	2	0.2304
1477	1049	993	995	1050	C28/35	2	0.2304
1478	1050	995	997	1051	C28/35	2	0.2304
1479	1051	997	999	1052	C28/35	2	0.2304
1480	1052	999	787	864	C28/35	2	0.2304
1481	1005	1053	1054	1006	C28/35	2	0.2304
1482	1006	1054	1055	1007	C28/35	2	0.2304
1483	1007	1055	1056	1008	C28/35	2	0.2304

Sovrapasso di ingresso - Ponte strallato - Relazione di calcolo

1484	1008	1056	870	869	C28/35	2	0.2304
1485	1053	1057	1058	1054	C28/35	2	0.2304
1486	1054	1058	1059	1055	C28/35	2	0.2304
1487	1055	1059	1060	1056	C28/35	2	0.2304
1488	1056	1060	871	870	C28/35	2	0.2304
1489	1057	1061	1062	1058	C28/35	2	0.2304
1490	1058	1062	1063	1059	C28/35	2	0.2304
1491	1059	1063	1064	1060	C28/35	2	0.2304
1492	1060	1064	872	871	C28/35	2	0.2304
1493	1061	1009	1011	1062	C28/35	2	0.2304
1494	1062	1011	1013	1063	C28/35	2	0.2304
1495	1063	1013	1015	1064	C28/35	2	0.2304
1496	1064	1015	789	872	C28/35	2	0.2304
1497	1025	1065	1066	1026	C28/35	2	0.2304
1498	1026	1066	1067	1027	C28/35	2	0.2304
1499	1027	1067	1068	1028	C28/35	2	0.2304
1500	1028	1068	934	933	C28/35	2	0.2304
1501	1065	1069	1070	1066	C28/35	2	0.2304
1502	1066	1070	1071	1067	C28/35	2	0.2304
1503	1067	1071	1072	1068	C28/35	2	0.2304
1504	1068	1072	935	934	C28/35	2	0.2304
1505	1069	1073	1074	1070	C28/35	2	0.2304
1506	1070	1074	1075	1071	C28/35	2	0.2304
1507	1071	1075	1076	1072	C28/35	2	0.2304
1508	1072	1076	936	935	C28/35	2	0.2304
1509	1073	1017	1019	1074	C28/35	2	0.2304
1510	1074	1019	1021	1075	C28/35	2	0.2304
1511	1075	1021	1023	1076	C28/35	2	0.2304
1512	1076	1023	798	936	C28/35	2	0.2304
1513	1077	860	814	1078	C28/35	2	0.48
1514	1079	788	816	1080	C28/35	2	0.48
1515	1081	859	994	1082	C28/35	2	0.288
1516	1083	791	1001	1084	C28/35	2	0.288
1517	1082	994	996	1085	C28/35	2	0.288
1518	1085	996	998	1086	C28/35	2	0.288
1519	1086	998	1000	1087	C28/35	2	0.288
1520	1087	1000	860	1077	C28/35	2	0.288
1521	1084	1001	1002	1088	C28/35	2	0.288
1522	1088	1002	1003	1089	C28/35	2	0.288
1523	1089	1003	1004	1090	C28/35	2	0.288
1524	1090	1004	788	1079	C28/35	2	0.288
1525	1091	1092	1094	1093	C28/35	2	0.4187
1526	1093	1094	793	834	C28/35	2	0.4187
1527	1092	1095	1096	1094	C28/35	2	0.2669
1528	1094	1096	909	793	C28/35	2	0.2564
1529	1097	1098	1100	1099	C28/35	2	0.4187
1530	1099	1100	843	790	C28/35	2	0.4187
1531	1101	1102	1104	1103	C28/35	2	0.2669
1532	1103	1104	913	791	C28/35	2	0.2564
1533	1095	1105	1106	1096	C28/35	2	0.2669
1534	1096	1106	910	909	C28/35	2	0.2564
1535	1105	1107	1108	1106	C28/35	2	0.2669
1536	1106	1108	911	910	C28/35	2	0.2564
1537	1107	1109	1110	1108	C28/35	2	0.2669
1538	1108	1110	912	911	C28/35	2	0.2564
1539	1109	1111	1112	1110	C28/35	2	0.2669
1540	1110	1112	792	912	C28/35	2	0.2564
1541	1102	1113	1114	1104	C28/35	2	0.2669
1542	1104	1114	914	913	C28/35	2	0.2564
1543	1113	1115	1116	1114	C28/35	2	0.2669
1544	1114	1116	915	914	C28/35	2	0.2564
1545	1115	1117	1118	1116	C28/35	2	0.2669
1546	1116	1118	916	915	C28/35	2	0.2564
1547	1117	1097	1099	1118	C28/35	2	0.2669
1548	1118	1099	790	916	C28/35	2	0.2564
1549	1119	1120	824	840	C28/35	2	0.332
1550	1120	1121	905	824	C28/35	2	0.2179
1551	1122	1123	849	826	C28/35	2	0.332
1552	1124	1125	945	780	C28/35	2	0.2179
1553	1121	1126	906	905	C28/35	2	0.2179
1554	1126	1127	907	906	C28/35	2	0.2179
1555	1127	1128	908	907	C28/35	2	0.2179
1556	1128	1129	781	908	C28/35	2	0.2179
1557	1125	1130	946	945	C28/35	2	0.2179
1558	1130	1131	947	946	C28/35	2	0.2179
1559	1131	1132	948	947	C28/35	2	0.2179
1560	1132	1122	826	948	C28/35	2	0.2179
1561	1133	1134	813	839	C28/35	2	0.48
1562	1135	1136	794	835	C28/35	2	0.48
1563	1137	1138	851	812	C28/35	2	0.18
1564	1139	1140	853	795	C28/35	2	0.18
1565	1138	1141	500	851	C28/35	2	0.54
1566	1141	1142	855	500	C28/35	2	0.54
1567	1140	1143	829	853	C28/35	2	0.54
1568	1143	1144	857	829	C28/35	2	0.54
1569	1142	1145	811	855	C28/35	2	0.18
1570	1144	1146	796	857	C28/35	2	0.18
1571	1134	1147	897	813	C28/35	2	0.288
1572	1136	1148	901	794	C28/35	2	0.288
1573	1149	1150	848	810	C28/35	2	0.48
1574	1151	1152	844	797	C28/35	2	0.48
1575	1145	1153	937	811	C28/35	2	0.288
1576	1146	1154	941	796	C28/35	2	0.288
1577	1147	1155	898	897	C28/35	2	0.288
1578	1155	1156	899	898	C28/35	2	0.288
1579	1156	1157	900	899	C28/35	2	0.288
1580	1157	1137	812	900	C28/35	2	0.288
1581	1148	1158	902	901	C28/35	2	0.288
1582	1158	1159	903	902	C28/35	2	0.288
1583	1159	1160	904	903	C28/35	2	0.288

Sovrapasso di ingresso - Ponte strallato - Relazione di calcolo

1584	1160	1139	795	904	C28/35	2	0.288
1585	1153	1161	938	937	C28/35	2	0.288
1586	1161	1162	939	938	C28/35	2	0.288
1587	1162	1163	940	939	C28/35	2	0.288
1588	1163	1149	810	940	C28/35	2	0.288
1589	1154	1164	942	941	C28/35	2	0.288
1590	1164	1165	943	942	C28/35	2	0.288
1591	1165	1166	944	943	C28/35	2	0.288
1592	1166	1151	797	944	C28/35	2	0.288
1593	1167	1168	802	837	C28/35	2	0.436
1594	1168	1169	889	802	C28/35	2	0.2698
1595	1170	1171	846	805	C28/35	2	0.436
1596	1172	1173	929	804	C28/35	2	0.2698
1597	1169	1174	890	889	C28/35	2	0.2698
1598	1174	1175	891	890	C28/35	2	0.2698
1599	1175	1176	892	891	C28/35	2	0.2698
1600	1176	1177	803	892	C28/35	2	0.2698
1601	1173	1178	930	929	C28/35	2	0.2698
1602	1178	1179	931	930	C28/35	2	0.2698
1603	1179	1180	932	931	C28/35	2	0.2698
1604	1180	1170	805	932	C28/35	2	0.2698
1605	1181	1182	825	841	C28/35	2	0.524
1606	1182	1183	885	825	C28/35	2	0.3439
1607	1184	1185	850	827	C28/35	2	0.524
1609	1183	1188	886	885	C28/35	2	0.3439
1610	1188	1189	887	886	C28/35	2	0.3439
1611	1189	1190	888	887	C28/35	2	0.3439
1613	1187	1192	926	925	C28/35	2	0.3439
1614	1192	1193	927	926	C28/35	2	0.3439
1615	1193	1194	928	927	C28/35	2	0.3439
1616	1194	1184	827	928	C28/35	2	0.3439
1625	781	1202	1111	0	C28/35	2	0.0693
1626	780	1101	1203	0	C28/35	2	0.0693
1637	781	832	1206	1202	C28/35	2	0.4279
1638	832	780	1203	1206	C28/35	2	0.4279
1639	1202	1206	1207	778	C28/35	2	0.4611
1640	1206	1203	779	1207	C28/35	2	0.4611
1641	1111	1202	778	1112	C28/35	2	0.267
1642	1203	1101	1103	779	C28/35	2	0.267
1643	1112	778	1081	792	C28/35	2	0.2582
1644	779	1103	791	1083	C28/35	2	0.2582
1645	778	1207	859	1081	C28/35	2	0.165
1646	1207	779	1083	859	C28/35	2	0.165
1651	1209	1210	832	781	C28/35	2	0.3735
1652	1210	1211	780	832	C28/35	2	0.3735
1653	1129	1209	781	0	C28/35	2	0.03112
1654	1211	1124	780	0	C28/35	2	0.03112
1655	795	853	1209	1129	C28/35	2	0.09337
1656	857	796	1124	1211	C28/35	2	0.09337
1665	821	807	1201	1200	C28/35	2	0.386
1666	1187	925	1197	1186	C28/35	2	0.3332
1667	925	1173	1172	1197	C28/35	2	0.2969
1668	807	1186	783	1201	C28/35	2	0.1663
1669	1172	804	977	858	C28/35	2	0.1087
1670	804	981	978	977	C28/35	2	0.144
1671	981	982	979	978	C28/35	2	0.144
1672	982	983	980	979	C28/35	2	0.189
1673	858	977	973	830	C28/35	2	0.432
1674	977	978	974	973	C28/35	2	0.432
1675	978	979	975	974	C28/35	2	0.432
1676	979	980	976	975	C28/35	2	0.702
1677	830	973	966	854	C28/35	2	0.432
1678	973	974	968	966	C28/35	2	0.432
1679	974	975	970	968	C28/35	2	0.432
1680	975	976	972	970	C28/35	2	0.702
1681	783	1197	1196	831	C28/35	2	0.4905
1682	1197	858	830	1196	C28/35	2	0.4905
1683	831	1196	1195	782	C28/35	2	0.4905
1684	1196	830	854	1195	C28/35	2	0.4905
1685	1212	1208	1204	785	C28/35	2	0.3671
1686	1208	831	782	1204	C28/35	2	0.5219
1687	784	1205	1208	1212	C28/35	2	0.3671
1688	1205	783	831	1208	C28/35	2	0.5219
1689	1200	784	1212	819	C28/35	2	0.132
1690	819	1212	785	1198	C28/35	2	0.132
1691	1200	1201	1205	784	C28/35	2	0.1225
1692	785	1204	1199	1198	C28/35	2	0.1225
1693	1198	1199	808	822	C28/35	2	0.386
1694	1199	782	1191	808	C28/35	2	0.1663
1695	1191	1195	888	1190	C28/35	2	0.3332
1696	1195	1177	1176	888	C28/35	2	0.2969
1697	854	966	803	1177	C28/35	2	0.1087
1698	966	968	965	803	C28/35	2	0.144
1699	968	970	967	965	C28/35	2	0.144
1700	970	972	969	967	C28/35	2	0.189
1701	983	984	980	0	C28/35	2	0.072
1702	972	971	969	0	C28/35	2	0.072
1703	1195	854	1177	0	C28/35	2	0.04087
1704	782	1195	1191	0	C28/35	2	0.04088
1705	1204	782	1199	0	C28/35	2	0.0548
1706	1201	783	1205	0	C28/35	2	0.0548
1707	1186	1197	783	0	C28/35	2	0.04088
1708	1197	1172	858	0	C28/35	2	0.04087

*** TOTAL WEIGHT / VOLUME / SURFACE AREA SUMMARY

SECTION NO	SECTION NAME	SURFACE AREA	VOLUMN	WEIGHT	FRAME NUMBER	TRUSS NUMBER
------------	--------------	--------------	--------	--------	--------------	--------------

Sovrapasso di ingresso - Ponte strallato - Relazione di calcolo

2	traversi	640.7	160.2	0	111	0
4	el rigido	110.9	13.86	0	68	0
5	tubo	237.5	1.9	146.2	24	0
8	baggiolo	5.76	1.152	28.24	6	0
11	FLC48	0	0.004653	0.6002	0	3
40	A1s	16.96	5.748	140.9	1	0
41	A2s	4.065	1.303	31.95	1	0
42	A3s	11.77	3.601	88.29	1	0
43	A4s	3.776	1.096	26.88	1	0
44	A5s	10.9	3.004	73.66	1	0
45	A6s	3.491	0.9085	22.28	1	0
46	A7s	6.765	1.684	41.3	1	0
47	A8s	3.276	0.7777	19.07	1	0
48	A9s	3.205	0.7361	18.05	1	0
49	A10s	6.195	1.352	33.15	1	0
50	A11s	2.991	0.6173	15.14	1	0
51	A12s	2.919	0.5796	14.21	1	0
52	A13s	5.627	1.051	25.77	1	0
59	3i	0	2.074	207.4	0	14
60	A14s	2.705	0.4726	11.59	1	0
61	A15s	3.065	0.5087	12.47	1	0
62	A1d	16.96	5.748	140.9	1	0
63	A2d	4.065	1.303	31.95	1	0
66	fittizia	3.353	0.008382	0	29	0
67	Pila	130.1	79.52	1329	6	0
68	A3d	11.77	3.601	88.29	1	0
69	A4d	3.776	1.096	26.88	1	0
70	A5d	10.9	3.004	73.66	1	0
71	A6d	3.491	0.9085	22.28	1	0
72	A7d	6.765	1.684	41.3	1	0
73	A8d	3.276	0.7777	19.07	1	0
74	A9d	3.205	0.7361	18.05	1	0
75	A10d	6.195	1.352	33.15	1	0
76	A11d	2.991	0.6173	15.14	1	0
77	A12d	2.919	0.5796	14.21	1	0
78	A13d	5.627	1.051	25.77	1	0
79	A14d	2.705	0.4726	11.59	1	0
80	A15d	3.065	0.5087	12.47	1	0
84	tubo219.1x12	26.02	0.1561	12.02	20	0
85	2UPN220	75.54	0.3823	29.43	20	0
94	A16s	17.78	7.896	193.6	1	0
95	A17s	20.39	8.686	213	1	0
96	A18s	19.25	7.644	187.4	1	0
97	A19s	18.11	6.665	163.4	1	0
98	A16d	17.78	7.896	193.6	1	0
99	A17d	20.39	8.686	213	1	0
100	A18d	19.25	7.644	187.4	1	0
101	A19d	18.11	6.665	163.4	1	0
102	Impalcato 30-3-	4142	48.61	3742	122	0
103	f-Impalcato 30-	864.3	10.03	772.2	40	0

*** LOAD DATA

; Self Weight, Nodal Load, Specified Displacement, Beam Load, Floor Load, Finishing Material Load, System Temperature, Nodal Temperature, Element Temperature, Beam Section Temperature, Wind Load, Static Seismic Load, Time History Analysis Data

[LOAD CASE : G1]

** SELF WEIGHT DATA

; X=0, Y=0, Z=-1

** NODAL LOAD DATA

NODE	FX	FY	FZ	MX	MY	MZ
387	0	0	-4.266	0	0	0
388	0	0	-4.266	0	0	0
597	0	0	-4.266	0	0	0
598	0	0	-4.266	0	0	0
599	0	0	-4.266	0	0	0
600	0	0	-4.266	0	0	0
601	0	0	-4.266	0	0	0
602	0	0	-4.266	0	0	0
603	0	0	-4.266	0	0	0
604	0	0	-4.266	0	0	0
605	0	0	-4.266	0	0	0
606	0	0	-4.266	0	0	0
607	0	0	-4.266	0	0	0
608	0	0	-4.266	0	0	0
609	0	0	-4.266	0	0	0
610	0	0	-4.266	0	0	0
611	0	0	-4.266	0	0	0
612	0	0	-4.266	0	0	0
613	0	0	-4.266	0	0	0
614	0	0	-4.266	0	0	0
615	0	0	-4.266	0	0	0
616	0	0	-4.266	0	0	0
772	0	0	-743.7	0	0	0
773	0	0	-743.7	0	0	0

** BEAM LOAD DATA

MEMBER	TYPE	DIR.	PROJ.	D1	P1	D2	P2	D3	P3	D4	P4
234	Uniform Load	GZ	NO	0.33	-1.49	1	-1.49	0	0	0	0

Sovrapasso di ingresso - Ponte strallato - Relazione di calcolo

528	Uniform Load	GZ	NO	0	-1.78	1	-1.78	0	0	0	0
529	Uniform Load	GZ	NO	0	-1.49	1	-1.49	0	0	0	0
530	Uniform Load	GZ	NO	0	-1.49	1	-1.49	0	0	0	0
531	Uniform Load	GZ	NO	0	-1.49	1	-1.49	0	0	0	0
532	Uniform Load	GZ	NO	0	-1.49	1	-1.49	0	0	0	0
533	Uniform Load	GZ	NO	0	-1.49	1	-1.49	0	0	0	0
534	Uniform Load	GZ	NO	0	-1.49	1	-1.49	0	0	0	0
535	Uniform Load	GZ	NO	0	-1.49	1	-1.49	0	0	0	0
536	Uniform Load	GZ	NO	0	-1.49	1	-1.49	0	0	0	0
537	Uniform Load	GZ	NO	0	-1.78	1	-1.78	0	0	0	0
538	Uniform Load	GZ	NO	0	-1.78	1	-1.78	0	0	0	0
539	Uniform Load	GZ	NO	0	-1.78	1	-1.78	0	0	0	0
555	Uniform Load	GZ	NO	0	-1.78	1	-1.78	0	0	0	0
559	Uniform Load	GZ	NO	0.63	-1.49	1	-1.49	0	0	0	0
559	Uniform Load	GZ	NO	0	-1.49	0.63	-1.49	0	0	0	0
568	Uniform Load	GZ	NO	0	-1.78	1	-1.78	0	0	0	0
569	Uniform Load	GZ	NO	0	-1.78	1	-1.78	0	0	0	0
570	Uniform Load	GZ	NO	0	-1.49	1	-1.49	0	0	0	0
571	Uniform Load	GZ	NO	0	-1.49	1	-1.49	0	0	0	0
572	Uniform Load	GZ	NO	0	-1.49	1	-1.49	0	0	0	0
573	Uniform Load	GZ	NO	0	-1.49	1	-1.49	0	0	0	0
574	Uniform Load	GZ	NO	0	-1.49	1	-1.49	0	0	0	0
575	Uniform Load	GZ	NO	0	-1.49	1	-1.49	0	0	0	0
576	Uniform Load	GZ	NO	0	-1.49	1	-1.49	0	0	0	0
577	Uniform Load	GZ	NO	0	-1.49	1	-1.49	0	0	0	0
628	Uniform Load	GZ	NO	0	-1.49	1	-1.49	0	0	0	0
629	Uniform Load	GZ	NO	0	-1.49	1	-1.49	0	0	0	0
630	Uniform Load	GZ	NO	0	-1.49	1	-1.49	0	0	0	0
631	Uniform Load	GZ	NO	0	-1.49	1	-1.49	0	0	0	0
632	Uniform Load	GZ	NO	0	-1.49	1	-1.49	0	0	0	0
633	Uniform Load	GZ	NO	0	-1.49	1	-1.49	0	0	0	0
634	Uniform Load	GZ	NO	0	-1.49	1	-1.49	0	0	0	0
635	Uniform Load	GZ	NO	0	-1.49	1	-1.49	0	0	0	0
636	Uniform Load	GZ	NO	0	-1.78	1	-1.78	0	0	0	0
637	Uniform Load	GZ	NO	0	-1.78	1	-1.78	0	0	0	0
641	Uniform Load	GZ	NO	0	-1.49	0.63	-1.49	0	0	0	0
641	Uniform Load	GZ	NO	0.63	-1.49	1	-1.49	0	0	0	0
962	Uniform Load	GZ	NO	0	-1.78	1	-1.78	0	0	0	0
963	Uniform Load	GZ	NO	0	-1.49	1	-1.49	0	0	0	0
964	Uniform Load	GZ	NO	0	-1.49	1	-1.49	0	0	0	0
970	Uniform Load	GZ	NO	0	-1.49	1	-1.49	0	0	0	0
978	Uniform Load	GZ	NO	0	-1.49	1	-1.49	0	0	0	0
979	Uniform Load	GZ	NO	0	-1.78	1	-1.78	0	0	0	0
1709	Uniform Load	GZ	NO	0	-1.78	1	-1.78	0	0	0	0
1713	Uniform Load	GZ	NO	0	-1.78	1	-1.78	0	0	0	0
1717	Uniform Load	GZ	NO	0	-1.78	1	-1.78	0	0	0	0

[LOAD CASE : G2]

** BEAM LOAD DATA

MEMBER	TYPE	DIR.	PROJ.	D1	P1	D2	P2	D3	P3	D4	P4
1	Uniform Load	GZ	NO	0	-1	1	-1	0	0	0	0
2	Uniform Load	GZ	NO	0	-1	1	-1	0	0	0	0
77	Uniform Load	GZ	NO	0	-0.25	1	-0.25	0	0	0	0
84	Uniform Load	GZ	NO	0	-0.25	1	-0.25	0	0	0	0
86	Uniform Load	GZ	NO	0	-0.25	1	-0.25	0	0	0	0
89	Uniform Load	GZ	NO	0	-0.25	1	-0.25	0	0	0	0
93	Uniform Load	GZ	NO	0	-0.25	1	-0.25	0	0	0	0
100	Uniform Load	GZ	NO	0	-0.25	1	-0.25	0	0	0	0
102	Uniform Load	GZ	NO	0	-0.25	1	-0.25	0	0	0	0
105	Uniform Load	GZ	NO	0	-0.25	1	-0.25	0	0	0	0
109	Uniform Load	GZ	NO	0	-0.25	1	-0.25	0	0	0	0
135	Uniform Load	GZ	NO	0	-0.25	1	-0.25	0	0	0	0
137	Uniform Load	GZ	NO	0	-0.25	1	-0.25	0	0	0	0
139	Uniform Load	GZ	NO	0	-0.25	1	-0.25	0	0	0	0
141	Uniform Load	GZ	NO	0	-0.25	1	-0.25	0	0	0	0
143	Uniform Load	GZ	NO	0	-0.25	1	-0.25	0	0	0	0
144	Uniform Load	GZ	NO	0	-0.25	1	-0.25	0	0	0	0
145	Uniform Load	GZ	NO	0	-0.25	1	-0.25	0	0	0	0
146	Uniform Load	GZ	NO	0	-0.25	1	-0.25	0	0	0	0
147	Uniform Load	GZ	NO	0	-0.25	1	-0.25	0	0	0	0
148	Uniform Load	GZ	NO	0	-0.25	1	-0.25	0	0	0	0
149	Uniform Load	GZ	NO	0	-0.25	1	-0.25	0	0	0	0
150	Uniform Load	GZ	NO	0	-0.25	1	-0.25	0	0	0	0
151	Uniform Load	GZ	NO	0	-0.25	1	-0.25	0	0	0	0
152	Uniform Load	GZ	NO	0	-0.25	1	-0.25	0	0	0	0
153	Uniform Load	GZ	NO	0	-0.25	1	-0.25	0	0	0	0
154	Uniform Load	GZ	NO	0	-0.25	1	-0.25	0	0	0	0
155	Uniform Load	GZ	NO	0	-0.25	1	-0.25	0	0	0	0
156	Uniform Load	GZ	NO	0	-0.25	1	-0.25	0	0	0	0
157	Uniform Load	GZ	NO	0	-0.25	1	-0.25	0	0	0	0
158	Uniform Load	GZ	NO	0	-0.25	1	-0.25	0	0	0	0
159	Uniform Load	GZ	NO	0	-0.25	1	-0.25	0	0	0	0
160	Uniform Load	GZ	NO	0	-0.25	1	-0.25	0	0	0	0
161	Uniform Load	GZ	NO	0	-0.25	1	-0.25	0	0	0	0
162	Uniform Load	GZ	NO	0	-0.25	1	-0.25	0	0	0	0
980	Uniform Load	GZ	NO	0	-1	1	-1	0	0	0	0
981	Uniform Load	GZ	NO	0	-1	1	-1	0	0	0	0
982	Uniform Load	GZ	NO	0	-1	1	-1	0	0	0	0
983	Uniform Load	GZ	NO	0	-1	1	-1	0	0	0	0
984	Uniform Load	GZ	NO	0	-1	1	-1	0	0	0	0
985	Uniform Load	GZ	NO	0	-1	1	-1	0	0	0	0
986	Uniform Load	GZ	NO	0	-1	1	-1	0	0	0	0
987	Uniform Load	GZ	NO	0	-1	1	-1	0	0	0	0
988	Uniform Load	GZ	NO	0	-1	1	-1	0	0	0	0
991	Uniform Load	GZ	NO	0	-1	1	-1	0	0	0	0
992	Uniform Load	GZ	NO	0	-1	1	-1	0	0	0	0

Sovrapasso di ingresso - Ponte strallato - Relazione di calcolo

993	Uniform Load	GZ	NO	0	-1	1	-1	0	0	0	0
994	Uniform Load	GZ	NO	0	-1	1	-1	0	0	0	0
995	Uniform Load	GZ	NO	0	-1	1	-1	0	0	0	0
996	Uniform Load	GZ	NO	0	-1	1	-1	0	0	0	0
997	Uniform Load	GZ	NO	0	-1	1	-1	0	0	0	0
998	Uniform Load	GZ	NO	0	-1	1	-1	0	0	0	0
999	Uniform Load	GZ	NO	0	-1	1	-1	0	0	0	0
1000	Uniform Load	GZ	NO	0	-6.6	1	-6.6	0	0	0	0
1000	Uniform Load	GZ	NO	0	-8.45	1	-8.45	0	0	0	0
1000	Uniform Load	GZ	NO	0	-2.25	1	-2.25	0	0	0	0
1000	Uniform Load	GZ	NO	0	-1	1	-1	0	0	0	0
1000	Uniform Load	GZ	NO	0	-0.39	1	-0.39	0	0	0	0
1000	Uniform Load	GZ	NO	0	-0.71	1	-0.71	0	0	0	0
1000	Uniform Load	GZ	NO	0	-2.6	1	-2.6	0	0	0	0
1001	Uniform Load	GZ	NO	0	-0.71	1	-0.71	0	0	0	0
1001	Uniform Load	GZ	NO	0	-6.6	1	-6.6	0	0	0	0
1001	Uniform Load	GZ	NO	0	-0.39	1	-0.39	0	0	0	0
1001	Uniform Load	GZ	NO	0	-2.25	1	-2.25	0	0	0	0
1001	Uniform Load	GZ	NO	0	-1	1	-1	0	0	0	0
1001	Uniform Load	GZ	NO	0	-2.6	1	-2.6	0	0	0	0
1001	Uniform Load	GZ	NO	0	-8.45	1	-8.45	0	0	0	0
1002	Uniform Load	GZ	NO	0	-1	1	-1	0	0	0	0
1002	Uniform Load	GZ	NO	0	-8.45	1	-8.45	0	0	0	0
1002	Uniform Load	GZ	NO	0	-0.39	1	-0.39	0	0	0	0
1002	Uniform Load	GZ	NO	0	-2.6	1	-2.6	0	0	0	0
1002	Uniform Load	GZ	NO	0	-0.71	1	-0.71	0	0	0	0
1002	Uniform Load	GZ	NO	0	-2.25	1	-2.25	0	0	0	0
1002	Uniform Load	GZ	NO	0	-6.6	1	-6.6	0	0	0	0
1003	Uniform Load	GZ	NO	0	-1	1	-1	0	0	0	0
1003	Uniform Load	GZ	NO	0	-0.71	1	-0.71	0	0	0	0
1003	Uniform Load	GZ	NO	0	-2.25	1	-2.25	0	0	0	0
1003	Uniform Load	GZ	NO	0	-0.39	1	-0.39	0	0	0	0
1003	Uniform Load	GZ	NO	0	-8.45	1	-8.45	0	0	0	0
1003	Uniform Load	GZ	NO	0	-6.6	1	-6.6	0	0	0	0
1003	Uniform Load	GZ	NO	0	-2.6	1	-2.6	0	0	0	0
1004	Uniform Load	GZ	NO	0	-0.39	1	-0.39	0	0	0	0
1004	Uniform Load	GZ	NO	0	-6.6	1	-6.6	0	0	0	0
1004	Uniform Load	GZ	NO	0	-2.6	1	-2.6	0	0	0	0
1004	Uniform Load	GZ	NO	0	-0.71	1	-0.71	0	0	0	0
1004	Uniform Load	GZ	NO	0	-1	1	-1	0	0	0	0
1004	Uniform Load	GZ	NO	0	-8.45	1	-8.45	0	0	0	0
1004	Uniform Load	GZ	NO	0	-2.25	1	-2.25	0	0	0	0
1005	Uniform Load	GZ	NO	0	-1	1	-1	0	0	0	0
1005	Uniform Load	GZ	NO	0	-8.45	1	-8.45	0	0	0	0
1005	Uniform Load	GZ	NO	0	-2.6	1	-2.6	0	0	0	0
1005	Uniform Load	GZ	NO	0	-6.6	1	-6.6	0	0	0	0
1005	Uniform Load	GZ	NO	0	-2.25	1	-2.25	0	0	0	0
1005	Uniform Load	GZ	NO	0	-0.71	1	-0.71	0	0	0	0
1005	Uniform Load	GZ	NO	0	-0.39	1	-0.39	0	0	0	0
1006	Uniform Load	GZ	NO	0	-2.6	1	-2.6	0	0	0	0
1006	Uniform Load	GZ	NO	0	-6.6	1	-6.6	0	0	0	0
1006	Uniform Load	GZ	NO	0	-0.39	1	-0.39	0	0	0	0
1006	Uniform Load	GZ	NO	0	-8.45	1	-8.45	0	0	0	0
1006	Uniform Load	GZ	NO	0	-0.71	1	-0.71	0	0	0	0
1006	Uniform Load	GZ	NO	0	-1	1	-1	0	0	0	0
1006	Uniform Load	GZ	NO	0	-2.25	1	-2.25	0	0	0	0
1007	Uniform Load	GZ	NO	0	-0.71	1	-0.71	0	0	0	0
1007	Uniform Load	GZ	NO	0	-6.6	1	-6.6	0	0	0	0
1007	Uniform Load	GZ	NO	0	-1	1	-1	0	0	0	0
1007	Uniform Load	GZ	NO	0	-2.25	1	-2.25	0	0	0	0
1007	Uniform Load	GZ	NO	0	-0.39	1	-0.39	0	0	0	0
1007	Uniform Load	GZ	NO	0	-2.6	1	-2.6	0	0	0	0
1007	Uniform Load	GZ	NO	0	-8.45	1	-8.45	0	0	0	0
1008	Uniform Load	GZ	NO	0	-1	1	-1	0	0	0	0
1008	Uniform Load	GZ	NO	0	-2.6	1	-2.6	0	0	0	0
1008	Uniform Load	GZ	NO	0	-8.45	1	-8.45	0	0	0	0
1008	Uniform Load	GZ	NO	0	-0.71	1	-0.71	0	0	0	0
1008	Uniform Load	GZ	NO	0	-0.39	1	-0.39	0	0	0	0
1008	Uniform Load	GZ	NO	0	-6.6	1	-6.6	0	0	0	0
1008	Uniform Load	GZ	NO	0	-2.25	1	-2.25	0	0	0	0
1009	Uniform Load	GZ	NO	0	-8.45	1	-8.45	0	0	0	0
1009	Uniform Load	GZ	NO	0	-0.39	1	-0.39	0	0	0	0
1009	Uniform Load	GZ	NO	0	-6.6	1	-6.6	0	0	0	0
1009	Uniform Load	GZ	NO	0	-2.25	1	-2.25	0	0	0	0
1009	Uniform Load	GZ	NO	0	-1	1	-1	0	0	0	0
1009	Uniform Load	GZ	NO	0	-2.6	1	-2.6	0	0	0	0
1009	Uniform Load	GZ	NO	0	-0.71	1	-0.71	0	0	0	0
1010	Uniform Load	GZ	NO	0	-0.71	1	-0.71	0	0	0	0
1010	Uniform Load	GZ	NO	0	-0.39	1	-0.39	0	0	0	0
1010	Uniform Load	GZ	NO	0	-2.6	1	-2.6	0	0	0	0
1010	Uniform Load	GZ	NO	0	-6.6	1	-6.6	0	0	0	0
1010	Uniform Load	GZ	NO	0	-2.25	1	-2.25	0	0	0	0
1010	Uniform Load	GZ	NO	0	-1	1	-1	0	0	0	0
1010	Uniform Load	GZ	NO	0	-8.45	1	-8.45	0	0	0	0
1011	Uniform Load	GZ	NO	0	-2.6	1	-2.6	0	0	0	0
1011	Uniform Load	GZ	NO	0	-6.6	1	-6.6	0	0	0	0
1011	Uniform Load	GZ	NO	0	-8.45	1	-8.45	0	0	0	0
1011	Uniform Load	GZ	NO	0	-0.39	1	-0.39	0	0	0	0
1011	Uniform Load	GZ	NO	0	-1	1	-1	0	0	0	0
1011	Uniform Load	GZ	NO	0	-2.25	1	-2.25	0	0	0	0
1011	Uniform Load	GZ	NO	0	-0.71	1	-0.71	0	0	0	0
1012	Uniform Load	GZ	NO	0	-0.71	1	-0.71	0	0	0	0
1012	Uniform Load	GZ	NO	0	-1	1	-1	0	0	0	0
1012	Uniform Load	GZ	NO	0	-6.6	1	-6.6	0	0	0	0
1012	Uniform Load	GZ	NO	0	-8.45	1	-8.45	0	0	0	0
1012	Uniform Load	GZ	NO	0	-0.39	1	-0.39	0	0	0	0
1012	Uniform Load	GZ	NO	0	-2.6	1	-2.6	0	0	0	0
1012	Uniform Load	GZ	NO	0	-2.25	1	-2.25	0	0	0	0
1013	Uniform Load	GZ	NO	0	-2.25	1	-2.25	0	0	0	0
1013	Uniform Load	GZ	NO	0	-6.6	1	-6.6	0	0	0	0

Sovrapasso di ingresso - Ponte strallato - Relazione di calcolo

1013	Uniform Load	GZ	NO	0	-0.39	1	-0.39	0	0	0	0
1013	Uniform Load	GZ	NO	0	-1	1	-1	0	0	0	0
1013	Uniform Load	GZ	NO	0	-8.45	1	-8.45	0	0	0	0
1013	Uniform Load	GZ	NO	0	-0.71	1	-0.71	0	0	0	0
1013	Uniform Load	GZ	NO	0	-2.6	1	-2.6	0	0	0	0
1014	Uniform Load	GZ	NO	0	-0.71	1	-0.71	0	0	0	0
1014	Uniform Load	GZ	NO	0	-8.45	1	-8.45	0	0	0	0
1014	Uniform Load	GZ	NO	0	-2.6	1	-2.6	0	0	0	0
1014	Uniform Load	GZ	NO	0	-0.39	1	-0.39	0	0	0	0
1014	Uniform Load	GZ	NO	0	-6.6	1	-6.6	0	0	0	0
1014	Uniform Load	GZ	NO	0	-1	1	-1	0	0	0	0
1014	Uniform Load	GZ	NO	0	-2.25	1	-2.25	0	0	0	0
1015	Uniform Load	GZ	NO	0	-0.71	1	-0.71	0	0	0	0
1015	Uniform Load	GZ	NO	0	-8.45	1	-8.45	0	0	0	0
1015	Uniform Load	GZ	NO	0	-2.25	1	-2.25	0	0	0	0
1015	Uniform Load	GZ	NO	0	-1	1	-1	0	0	0	0
1015	Uniform Load	GZ	NO	0	-0.39	1	-0.39	0	0	0	0
1015	Uniform Load	GZ	NO	0	-2.6	1	-2.6	0	0	0	0
1015	Uniform Load	GZ	NO	0	-6.6	1	-6.6	0	0	0	0
1016	Uniform Load	GZ	NO	0	-1	1	-1	0	0	0	0
1016	Uniform Load	GZ	NO	0	-2.25	1	-2.25	0	0	0	0
1016	Uniform Load	GZ	NO	0	-0.39	1	-0.39	0	0	0	0
1016	Uniform Load	GZ	NO	0	-8.45	1	-8.45	0	0	0	0
1016	Uniform Load	GZ	NO	0	-2.6	1	-2.6	0	0	0	0
1016	Uniform Load	GZ	NO	0	-0.71	1	-0.71	0	0	0	0
1016	Uniform Load	GZ	NO	0	-6.6	1	-6.6	0	0	0	0
1017	Uniform Load	GZ	NO	0	-1	1	-1	0	0	0	0
1017	Uniform Load	GZ	NO	0	-0.71	1	-0.71	0	0	0	0
1017	Uniform Load	GZ	NO	0	-6.6	1	-6.6	0	0	0	0
1017	Uniform Load	GZ	NO	0	-0.39	1	-0.39	0	0	0	0
1017	Uniform Load	GZ	NO	0	-8.45	1	-8.45	0	0	0	0
1017	Uniform Load	GZ	NO	0	-2.6	1	-2.6	0	0	0	0
1017	Uniform Load	GZ	NO	0	-2.25	1	-2.25	0	0	0	0
1018	Uniform Load	GZ	NO	0	-1	1	-1	0	0	0	0
1018	Uniform Load	GZ	NO	0	-6.6	1	-6.6	0	0	0	0
1018	Uniform Load	GZ	NO	0	-8.45	1	-8.45	0	0	0	0
1018	Uniform Load	GZ	NO	0	-2.25	1	-2.25	0	0	0	0
1018	Uniform Load	GZ	NO	0	-0.39	1	-0.39	0	0	0	0
1018	Uniform Load	GZ	NO	0	-0.71	1	-0.71	0	0	0	0
1018	Uniform Load	GZ	NO	0	-2.6	1	-2.6	0	0	0	0
1019	Uniform Load	GZ	NO	0	-0.71	1	-0.71	0	0	0	0
1019	Uniform Load	GZ	NO	0	-1	1	-1	0	0	0	0
1019	Uniform Load	GZ	NO	0	-2.25	1	-2.25	0	0	0	0
1019	Uniform Load	GZ	NO	0	-0.39	1	-0.39	0	0	0	0
1019	Uniform Load	GZ	NO	0	-6.6	1	-6.6	0	0	0	0
1019	Uniform Load	GZ	NO	0	-8.45	1	-8.45	0	0	0	0
1019	Uniform Load	GZ	NO	0	-2.6	1	-2.6	0	0	0	0
1020	Uniform Load	GZ	NO	0	-2.6	1	-2.6	0	0	0	0
1020	Uniform Load	GZ	NO	0	-2.25	1	-2.25	0	0	0	0
1020	Uniform Load	GZ	NO	0	-0.71	1	-0.71	0	0	0	0
1020	Uniform Load	GZ	NO	0	-8.45	1	-8.45	0	0	0	0
1020	Uniform Load	GZ	NO	0	-0.39	1	-0.39	0	0	0	0
1020	Uniform Load	GZ	NO	0	-6.6	1	-6.6	0	0	0	0
1020	Uniform Load	GZ	NO	0	-1	1	-1	0	0	0	0
1021	Uniform Load	GZ	NO	0	-8.45	1	-8.45	0	0	0	0
1021	Uniform Load	GZ	NO	0	-0.39	1	-0.39	0	0	0	0
1021	Uniform Load	GZ	NO	0	-6.6	1	-6.6	0	0	0	0
1021	Uniform Load	GZ	NO	0	-2.25	1	-2.25	0	0	0	0
1021	Uniform Load	GZ	NO	0	-0.71	1	-0.71	0	0	0	0
1021	Uniform Load	GZ	NO	0	-2.6	1	-2.6	0	0	0	0
1021	Uniform Load	GZ	NO	0	-1	1	-1	0	0	0	0
1022	Uniform Load	GZ	NO	0	-2.6	1	-2.6	0	0	0	0
1022	Uniform Load	GZ	NO	0	-6.6	1	-6.6	0	0	0	0
1022	Uniform Load	GZ	NO	0	-2.25	1	-2.25	0	0	0	0
1022	Uniform Load	GZ	NO	0	-0.71	1	-0.71	0	0	0	0
1022	Uniform Load	GZ	NO	0	-8.45	1	-8.45	0	0	0	0
1022	Uniform Load	GZ	NO	0	-0.39	1	-0.39	0	0	0	0
1022	Uniform Load	GZ	NO	0	-1	1	-1	0	0	0	0
1023	Uniform Load	GZ	NO	0	-8.45	1	-8.45	0	0	0	0
1023	Uniform Load	GZ	NO	0	-6.6	1	-6.6	0	0	0	0
1023	Uniform Load	GZ	NO	0	-2.6	1	-2.6	0	0	0	0
1023	Uniform Load	GZ	NO	0	-0.71	1	-0.71	0	0	0	0
1023	Uniform Load	GZ	NO	0	-1	1	-1	0	0	0	0
1023	Uniform Load	GZ	NO	0	-2.25	1	-2.25	0	0	0	0
1023	Uniform Load	GZ	NO	0	-0.39	1	-0.39	0	0	0	0
1024	Uniform Load	GZ	NO	0	-1	1	-1	0	0	0	0
1024	Uniform Load	GZ	NO	0	-8.45	1	-8.45	0	0	0	0
1024	Uniform Load	GZ	NO	0	-2.25	1	-2.25	0	0	0	0
1024	Uniform Load	GZ	NO	0	-0.39	1	-0.39	0	0	0	0
1024	Uniform Load	GZ	NO	0	-2.6	1	-2.6	0	0	0	0
1024	Uniform Load	GZ	NO	0	-0.71	1	-0.71	0	0	0	0
1024	Uniform Load	GZ	NO	0	-6.6	1	-6.6	0	0	0	0
1025	Uniform Load	GZ	NO	0	-0.71	1	-0.71	0	0	0	0
1025	Uniform Load	GZ	NO	0	-6.6	1	-6.6	0	0	0	0
1025	Uniform Load	GZ	NO	0	-0.39	1	-0.39	0	0	0	0
1025	Uniform Load	GZ	NO	0	-1	1	-1	0	0	0	0
1025	Uniform Load	GZ	NO	0	-2.25	1	-2.25	0	0	0	0
1025	Uniform Load	GZ	NO	0	-8.45	1	-8.45	0	0	0	0
1025	Uniform Load	GZ	NO	0	-2.6	1	-2.6	0	0	0	0
1026	Uniform Load	GZ	NO	0	-2.6	1	-2.6	0	0	0	0
1026	Uniform Load	GZ	NO	0	-2.25	1	-2.25	0	0	0	0
1026	Uniform Load	GZ	NO	0	-0.39	1	-0.39	0	0	0	0
1026	Uniform Load	GZ	NO	0	-8.45	1	-8.45	0	0	0	0
1026	Uniform Load	GZ	NO	0	-1	1	-1	0	0	0	0
1026	Uniform Load	GZ	NO	0	-0.71	1	-0.71	0	0	0	0
1026	Uniform Load	GZ	NO	0	-6.6	1	-6.6	0	0	0	0
1027	Uniform Load	GZ	NO	0	-1	1	-1	0	0	0	0
1027	Uniform Load	GZ	NO	0	-2.6	1	-2.6	0	0	0	0
1027	Uniform Load	GZ	NO	0	-2.25	1	-2.25	0	0	0	0
1027	Uniform Load	GZ	NO	0	-8.45	1	-8.45	0	0	0	0

Sovrapasso di ingresso - Ponte strallato - Relazione di calcolo

1027	Uniform Load	GZ	NO	0	-0.71	1	-0.71	0	0	0	0
1027	Uniform Load	GZ	NO	0	-0.39	1	-0.39	0	0	0	0
1027	Uniform Load	GZ	NO	0	-6.6	1	-6.6	0	0	0	0
1028	Uniform Load	GZ	NO	0	-6.6	1	-6.6	0	0	0	0
1028	Uniform Load	GZ	NO	0	-2.25	1	-2.25	0	0	0	0
1028	Uniform Load	GZ	NO	0	-0.39	1	-0.39	0	0	0	0
1028	Uniform Load	GZ	NO	0	-8.45	1	-8.45	0	0	0	0
1028	Uniform Load	GZ	NO	0	-1	1	-1	0	0	0	0
1028	Uniform Load	GZ	NO	0	-2.6	1	-2.6	0	0	0	0
1028	Uniform Load	GZ	NO	0	-0.71	1	-0.71	0	0	0	0
1029	Uniform Load	GZ	NO	0	-1	1	-1	0	0	0	0
1029	Uniform Load	GZ	NO	0	-2.25	1	-2.25	0	0	0	0
1029	Uniform Load	GZ	NO	0	-6.6	1	-6.6	0	0	0	0
1029	Uniform Load	GZ	NO	0	-0.39	1	-0.39	0	0	0	0
1029	Uniform Load	GZ	NO	0	-8.45	1	-8.45	0	0	0	0
1029	Uniform Load	GZ	NO	0	-2.6	1	-2.6	0	0	0	0
1029	Uniform Load	GZ	NO	0	-0.71	1	-0.71	0	0	0	0
1030	Uniform Load	GZ	NO	0	-0.71	1	-0.71	0	0	0	0
1030	Uniform Load	GZ	NO	0	-8.45	1	-8.45	0	0	0	0
1030	Uniform Load	GZ	NO	0	-2.25	1	-2.25	0	0	0	0
1030	Uniform Load	GZ	NO	0	-6.6	1	-6.6	0	0	0	0
1030	Uniform Load	GZ	NO	0	-1	1	-1	0	0	0	0
1030	Uniform Load	GZ	NO	0	-0.39	1	-0.39	0	0	0	0
1030	Uniform Load	GZ	NO	0	-2.6	1	-2.6	0	0	0	0
1031	Uniform Load	GZ	NO	0	-2.25	1	-2.25	0	0	0	0
1031	Uniform Load	GZ	NO	0	-0.71	1	-0.71	0	0	0	0
1031	Uniform Load	GZ	NO	0	-6.6	1	-6.6	0	0	0	0
1031	Uniform Load	GZ	NO	0	-2.6	1	-2.6	0	0	0	0
1031	Uniform Load	GZ	NO	0	-1	1	-1	0	0	0	0
1031	Uniform Load	GZ	NO	0	-8.45	1	-8.45	0	0	0	0
1031	Uniform Load	GZ	NO	0	-0.39	1	-0.39	0	0	0	0
1032	Uniform Load	GZ	NO	0	-1	1	-1	0	0	0	0
1032	Uniform Load	GZ	NO	0	-8.45	1	-8.45	0	0	0	0
1032	Uniform Load	GZ	NO	0	-0.39	1	-0.39	0	0	0	0
1032	Uniform Load	GZ	NO	0	-2.6	1	-2.6	0	0	0	0
1032	Uniform Load	GZ	NO	0	-2.25	1	-2.25	0	0	0	0
1032	Uniform Load	GZ	NO	0	-0.71	1	-0.71	0	0	0	0
1032	Uniform Load	GZ	NO	0	-6.6	1	-6.6	0	0	0	0
1033	Uniform Load	GZ	NO	0	-0.39	1	-0.39	0	0	0	0
1033	Uniform Load	GZ	NO	0	-8.45	1	-8.45	0	0	0	0
1033	Uniform Load	GZ	NO	0	-2.6	1	-2.6	0	0	0	0
1033	Uniform Load	GZ	NO	0	-6.6	1	-6.6	0	0	0	0
1033	Uniform Load	GZ	NO	0	-2.25	1	-2.25	0	0	0	0
1033	Uniform Load	GZ	NO	0	-1	1	-1	0	0	0	0
1033	Uniform Load	GZ	NO	0	-0.71	1	-0.71	0	0	0	0
1034	Uniform Load	GZ	NO	0	-8.45	1	-8.45	0	0	0	0
1034	Uniform Load	GZ	NO	0	-6.6	1	-6.6	0	0	0	0
1034	Uniform Load	GZ	NO	0	-0.71	1	-0.71	0	0	0	0
1034	Uniform Load	GZ	NO	0	-2.6	1	-2.6	0	0	0	0
1034	Uniform Load	GZ	NO	0	-0.39	1	-0.39	0	0	0	0
1034	Uniform Load	GZ	NO	0	-2.25	1	-2.25	0	0	0	0
1034	Uniform Load	GZ	NO	0	-1	1	-1	0	0	0	0
1035	Uniform Load	GZ	NO	0	-6.6	1	-6.6	0	0	0	0
1035	Uniform Load	GZ	NO	0	-1	1	-1	0	0	0	0
1035	Uniform Load	GZ	NO	0	-0.39	1	-0.39	0	0	0	0
1035	Uniform Load	GZ	NO	0	-2.25	1	-2.25	0	0	0	0
1035	Uniform Load	GZ	NO	0	-8.45	1	-8.45	0	0	0	0
1035	Uniform Load	GZ	NO	0	-2.6	1	-2.6	0	0	0	0
1035	Uniform Load	GZ	NO	0	-0.71	1	-0.71	0	0	0	0
1036	Uniform Load	GZ	NO	0	-0.71	1	-0.71	0	0	0	0
1036	Uniform Load	GZ	NO	0	-8.45	1	-8.45	0	0	0	0
1036	Uniform Load	GZ	NO	0	-2.25	1	-2.25	0	0	0	0
1036	Uniform Load	GZ	NO	0	-1	1	-1	0	0	0	0
1036	Uniform Load	GZ	NO	0	-0.39	1	-0.39	0	0	0	0
1036	Uniform Load	GZ	NO	0	-6.6	1	-6.6	0	0	0	0
1036	Uniform Load	GZ	NO	0	-2.6	1	-2.6	0	0	0	0
1037	Uniform Load	GZ	NO	0	-1	1	-1	0	0	0	0
1037	Uniform Load	GZ	NO	0	-0.71	1	-0.71	0	0	0	0
1037	Uniform Load	GZ	NO	0	-2.25	1	-2.25	0	0	0	0
1037	Uniform Load	GZ	NO	0	-8.45	1	-8.45	0	0	0	0
1037	Uniform Load	GZ	NO	0	-0.39	1	-0.39	0	0	0	0
1037	Uniform Load	GZ	NO	0	-6.6	1	-6.6	0	0	0	0
1037	Uniform Load	GZ	NO	0	-2.6	1	-2.6	0	0	0	0
1038	Uniform Load	GZ	NO	0	-2.6	1	-2.6	0	0	0	0
1038	Uniform Load	GZ	NO	0	-2.25	1	-2.25	0	0	0	0
1038	Uniform Load	GZ	NO	0	-0.71	1	-0.71	0	0	0	0
1038	Uniform Load	GZ	NO	0	-6.6	1	-6.6	0	0	0	0
1038	Uniform Load	GZ	NO	0	-1	1	-1	0	0	0	0
1038	Uniform Load	GZ	NO	0	-0.39	1	-0.39	0	0	0	0
1038	Uniform Load	GZ	NO	0	-8.45	1	-8.45	0	0	0	0
1039	Uniform Load	GZ	NO	0	-2.25	1	-2.25	0	0	0	0
1039	Uniform Load	GZ	NO	0	-6.6	1	-6.6	0	0	0	0
1039	Uniform Load	GZ	NO	0	-0.39	1	-0.39	0	0	0	0
1039	Uniform Load	GZ	NO	0	-8.45	1	-8.45	0	0	0	0
1039	Uniform Load	GZ	NO	0	-2.6	1	-2.6	0	0	0	0
1039	Uniform Load	GZ	NO	0	-0.71	1	-0.71	0	0	0	0
1039	Uniform Load	GZ	NO	0	-1	1	-1	0	0	0	0
1040	Uniform Load	GZ	NO	0	-2.6	1	-2.6	0	0	0	0
1040	Uniform Load	GZ	NO	0	-6.6	1	-6.6	0	0	0	0
1040	Uniform Load	GZ	NO	0	-0.39	1	-0.39	0	0	0	0
1040	Uniform Load	GZ	NO	0	-0.71	1	-0.71	0	0	0	0
1040	Uniform Load	GZ	NO	0	-2.25	1	-2.25	0	0	0	0
1040	Uniform Load	GZ	NO	0	-1	1	-1	0	0	0	0
1040	Uniform Load	GZ	NO	0	-8.45	1	-8.45	0	0	0	0
1041	Uniform Load	GZ	NO	0	-8.45	1	-8.45	0	0	0	0
1041	Uniform Load	GZ	NO	0	-0.39	1	-0.39	0	0	0	0
1041	Uniform Load	GZ	NO	0	-6.6	1	-6.6	0	0	0	0
1041	Uniform Load	GZ	NO	0	-2.6	1	-2.6	0	0	0	0
1041	Uniform Load	GZ	NO	0	-1	1	-1	0	0	0	0
1041	Uniform Load	GZ	NO	0	-2.25	1	-2.25	0	0	0	0

Sovrapasso di ingresso - Ponte strallato - Relazione di calcolo

1041	Uniform Load	GZ	NO	0	-0.71	1	-0.71	0	0	0	0
1042	Uniform Load	GZ	NO	0	-1	1	-1	0	0	0	0
1042	Uniform Load	GZ	NO	0	-2.6	1	-2.6	0	0	0	0
1042	Uniform Load	GZ	NO	0	-0.71	1	-0.71	0	0	0	0
1042	Uniform Load	GZ	NO	0	-8.45	1	-8.45	0	0	0	0
1042	Uniform Load	GZ	NO	0	-0.39	1	-0.39	0	0	0	0
1042	Uniform Load	GZ	NO	0	-6.6	1	-6.6	0	0	0	0
1042	Uniform Load	GZ	NO	0	-2.25	1	-2.25	0	0	0	0
1043	Uniform Load	GZ	NO	0	-8.45	1	-8.45	0	0	0	0
1043	Uniform Load	GZ	NO	0	-2.6	1	-2.6	0	0	0	0
1043	Uniform Load	GZ	NO	0	-0.71	1	-0.71	0	0	0	0
1043	Uniform Load	GZ	NO	0	-2.25	1	-2.25	0	0	0	0
1043	Uniform Load	GZ	NO	0	-1	1	-1	0	0	0	0
1043	Uniform Load	GZ	NO	0	-6.6	1	-6.6	0	0	0	0
1043	Uniform Load	GZ	NO	0	-0.39	1	-0.39	0	0	0	0
1044	Uniform Load	GZ	NO	0	-2.25	1	-2.25	0	0	0	0
1044	Uniform Load	GZ	NO	0	-8.45	1	-8.45	0	0	0	0
1044	Uniform Load	GZ	NO	0	-1	1	-1	0	0	0	0
1044	Uniform Load	GZ	NO	0	-2.6	1	-2.6	0	0	0	0
1044	Uniform Load	GZ	NO	0	-0.71	1	-0.71	0	0	0	0
1044	Uniform Load	GZ	NO	0	-6.6	1	-6.6	0	0	0	0
1044	Uniform Load	GZ	NO	0	-0.39	1	-0.39	0	0	0	0
1045	Uniform Load	GZ	NO	0	-0.39	1	-0.39	0	0	0	0
1045	Uniform Load	GZ	NO	0	-6.6	1	-6.6	0	0	0	0
1045	Uniform Load	GZ	NO	0	-1	1	-1	0	0	0	0
1045	Uniform Load	GZ	NO	0	-0.71	1	-0.71	0	0	0	0
1045	Uniform Load	GZ	NO	0	-2.25	1	-2.25	0	0	0	0
1045	Uniform Load	GZ	NO	0	-8.45	1	-8.45	0	0	0	0
1045	Uniform Load	GZ	NO	0	-2.6	1	-2.6	0	0	0	0
1046	Uniform Load	GZ	NO	0	-6.6	1	-6.6	0	0	0	0
1046	Uniform Load	GZ	NO	0	-0.71	1	-0.71	0	0	0	0
1046	Uniform Load	GZ	NO	0	-1	1	-1	0	0	0	0
1046	Uniform Load	GZ	NO	0	-2.25	1	-2.25	0	0	0	0
1046	Uniform Load	GZ	NO	0	-8.45	1	-8.45	0	0	0	0
1046	Uniform Load	GZ	NO	0	-0.39	1	-0.39	0	0	0	0
1046	Uniform Load	GZ	NO	0	-2.6	1	-2.6	0	0	0	0
1047	Uniform Load	GZ	NO	0	-6.6	1	-6.6	0	0	0	0
1047	Uniform Load	GZ	NO	0	-2.25	1	-2.25	0	0	0	0
1047	Uniform Load	GZ	NO	0	-0.71	1	-0.71	0	0	0	0
1047	Uniform Load	GZ	NO	0	-2.6	1	-2.6	0	0	0	0
1047	Uniform Load	GZ	NO	0	-8.45	1	-8.45	0	0	0	0
1047	Uniform Load	GZ	NO	0	-0.39	1	-0.39	0	0	0	0
1047	Uniform Load	GZ	NO	0	-1	1	-1	0	0	0	0
1048	Uniform Load	GZ	NO	0	-6.6	1	-6.6	0	0	0	0
1048	Uniform Load	GZ	NO	0	-8.45	1	-8.45	0	0	0	0
1048	Uniform Load	GZ	NO	0	-0.39	1	-0.39	0	0	0	0
1048	Uniform Load	GZ	NO	0	-0.71	1	-0.71	0	0	0	0
1048	Uniform Load	GZ	NO	0	-2.25	1	-2.25	0	0	0	0
1048	Uniform Load	GZ	NO	0	-1	1	-1	0	0	0	0
1048	Uniform Load	GZ	NO	0	-2.6	1	-2.6	0	0	0	0
1049	Uniform Load	GZ	NO	0	-2.25	1	-2.25	0	0	0	0
1049	Uniform Load	GZ	NO	0	-6.6	1	-6.6	0	0	0	0
1049	Uniform Load	GZ	NO	0	-2.6	1	-2.6	0	0	0	0
1049	Uniform Load	GZ	NO	0	-1	1	-1	0	0	0	0
1049	Uniform Load	GZ	NO	0	-8.45	1	-8.45	0	0	0	0
1049	Uniform Load	GZ	NO	0	-0.39	1	-0.39	0	0	0	0
1049	Uniform Load	GZ	NO	0	-0.71	1	-0.71	0	0	0	0
1050	Uniform Load	GZ	NO	0	-2.25	1	-2.25	0	0	0	0
1050	Uniform Load	GZ	NO	0	-8.45	1	-8.45	0	0	0	0
1050	Uniform Load	GZ	NO	0	-0.39	1	-0.39	0	0	0	0
1050	Uniform Load	GZ	NO	0	-2.6	1	-2.6	0	0	0	0
1050	Uniform Load	GZ	NO	0	-6.6	1	-6.6	0	0	0	0
1050	Uniform Load	GZ	NO	0	-1	1	-1	0	0	0	0
1050	Uniform Load	GZ	NO	0	-0.71	1	-0.71	0	0	0	0
1051	Uniform Load	GZ	NO	0	-1	1	-1	0	0	0	0
1051	Uniform Load	GZ	NO	0	-2.6	1	-2.6	0	0	0	0
1051	Uniform Load	GZ	NO	0	-6.6	1	-6.6	0	0	0	0
1051	Uniform Load	GZ	NO	0	-2.25	1	-2.25	0	0	0	0
1051	Uniform Load	GZ	NO	0	-0.39	1	-0.39	0	0	0	0
1051	Uniform Load	GZ	NO	0	-8.45	1	-8.45	0	0	0	0
1051	Uniform Load	GZ	NO	0	-0.71	1	-0.71	0	0	0	0
1052	Uniform Load	GZ	NO	0	-6.6	1	-6.6	0	0	0	0
1052	Uniform Load	GZ	NO	0	-2.6	1	-2.6	0	0	0	0
1052	Uniform Load	GZ	NO	0	-2.25	1	-2.25	0	0	0	0
1052	Uniform Load	GZ	NO	0	-0.71	1	-0.71	0	0	0	0
1052	Uniform Load	GZ	NO	0	-1	1	-1	0	0	0	0
1052	Uniform Load	GZ	NO	0	-8.45	1	-8.45	0	0	0	0
1052	Uniform Load	GZ	NO	0	-0.39	1	-0.39	0	0	0	0
1053	Uniform Load	GZ	NO	0	-2.6	1	-2.6	0	0	0	0
1053	Uniform Load	GZ	NO	0	-1	1	-1	0	0	0	0
1053	Uniform Load	GZ	NO	0	-0.39	1	-0.39	0	0	0	0
1053	Uniform Load	GZ	NO	0	-8.45	1	-8.45	0	0	0	0
1053	Uniform Load	GZ	NO	0	-0.71	1	-0.71	0	0	0	0
1053	Uniform Load	GZ	NO	0	-6.6	1	-6.6	0	0	0	0
1053	Uniform Load	GZ	NO	0	-2.25	1	-2.25	0	0	0	0
1054	Uniform Load	GZ	NO	0	-1	1	-1	0	0	0	0
1054	Uniform Load	GZ	NO	0	-0.39	1	-0.39	0	0	0	0
1054	Uniform Load	GZ	NO	0	-8.45	1	-8.45	0	0	0	0
1054	Uniform Load	GZ	NO	0	-2.25	1	-2.25	0	0	0	0
1054	Uniform Load	GZ	NO	0	-2.6	1	-2.6	0	0	0	0
1054	Uniform Load	GZ	NO	0	-0.71	1	-0.71	0	0	0	0
1054	Uniform Load	GZ	NO	0	-6.6	1	-6.6	0	0	0	0
1055	Uniform Load	GZ	NO	0	-0.71	1	-0.71	0	0	0	0
1055	Uniform Load	GZ	NO	0	-8.45	1	-8.45	0	0	0	0
1055	Uniform Load	GZ	NO	0	-1	1	-1	0	0	0	0
1055	Uniform Load	GZ	NO	0	-6.6	1	-6.6	0	0	0	0
1055	Uniform Load	GZ	NO	0	-0.39	1	-0.39	0	0	0	0
1055	Uniform Load	GZ	NO	0	-2.6	1	-2.6	0	0	0	0
1055	Uniform Load	GZ	NO	0	-2.25	1	-2.25	0	0	0	0
1056	Uniform Load	GZ	NO	0	-0.71	1	-0.71	0	0	0	0

Sovrapasso di ingresso - Ponte strallato - Relazione di calcolo

1056	Uniform Load	GZ	NO	0	-1	1	-1	0	0	0	0
1056	Uniform Load	GZ	NO	0	-6.6	1	-6.6	0	0	0	0
1056	Uniform Load	GZ	NO	0	-0.39	1	-0.39	0	0	0	0
1056	Uniform Load	GZ	NO	0	-2.25	1	-2.25	0	0	0	0
1056	Uniform Load	GZ	NO	0	-8.45	1	-8.45	0	0	0	0
1056	Uniform Load	GZ	NO	0	-2.6	1	-2.6	0	0	0	0
1057	Uniform Load	GZ	NO	0	-1	1	-1	0	0	0	0
1057	Uniform Load	GZ	NO	0	-0.71	1	-0.71	0	0	0	0
1057	Uniform Load	GZ	NO	0	-0.39	1	-0.39	0	0	0	0
1057	Uniform Load	GZ	NO	0	-2.6	1	-2.6	0	0	0	0
1057	Uniform Load	GZ	NO	0	-2.25	1	-2.25	0	0	0	0
1057	Uniform Load	GZ	NO	0	-6.6	1	-6.6	0	0	0	0
1057	Uniform Load	GZ	NO	0	-8.45	1	-8.45	0	0	0	0
1058	Uniform Load	GZ	NO	0	-0.71	1	-0.71	0	0	0	0
1058	Uniform Load	GZ	NO	0	-1	1	-1	0	0	0	0
1058	Uniform Load	GZ	NO	0	-2.6	1	-2.6	0	0	0	0
1058	Uniform Load	GZ	NO	0	-0.39	1	-0.39	0	0	0	0
1058	Uniform Load	GZ	NO	0	-2.25	1	-2.25	0	0	0	0
1058	Uniform Load	GZ	NO	0	-8.45	1	-8.45	0	0	0	0
1058	Uniform Load	GZ	NO	0	-6.6	1	-6.6	0	0	0	0
1059	Uniform Load	GZ	NO	0	-2.6	1	-2.6	0	0	0	0
1059	Uniform Load	GZ	NO	0	-0.39	1	-0.39	0	0	0	0
1059	Uniform Load	GZ	NO	0	-2.25	1	-2.25	0	0	0	0
1059	Uniform Load	GZ	NO	0	-8.45	1	-8.45	0	0	0	0
1059	Uniform Load	GZ	NO	0	-1	1	-1	0	0	0	0
1059	Uniform Load	GZ	NO	0	-6.6	1	-6.6	0	0	0	0
1059	Uniform Load	GZ	NO	0	-0.71	1	-0.71	0	0	0	0
1060	Uniform Load	GZ	NO	0	-2.6	1	-2.6	0	0	0	0
1060	Uniform Load	GZ	NO	0	-0.39	1	-0.39	0	0	0	0
1060	Uniform Load	GZ	NO	0	-0.71	1	-0.71	0	0	0	0
1060	Uniform Load	GZ	NO	0	-2.25	1	-2.25	0	0	0	0
1060	Uniform Load	GZ	NO	0	-8.45	1	-8.45	0	0	0	0
1060	Uniform Load	GZ	NO	0	-1	1	-1	0	0	0	0
1060	Uniform Load	GZ	NO	0	-6.6	1	-6.6	0	0	0	0
1061	Uniform Load	GZ	NO	0	-0.39	1	-0.39	0	0	0	0
1061	Uniform Load	GZ	NO	0	-8.45	1	-8.45	0	0	0	0
1061	Uniform Load	GZ	NO	0	-2.6	1	-2.6	0	0	0	0
1061	Uniform Load	GZ	NO	0	-6.6	1	-6.6	0	0	0	0
1061	Uniform Load	GZ	NO	0	-2.25	1	-2.25	0	0	0	0
1061	Uniform Load	GZ	NO	0	-0.71	1	-0.71	0	0	0	0
1061	Uniform Load	GZ	NO	0	-1	1	-1	0	0	0	0
1062	Uniform Load	GZ	NO	0	-0.71	1	-0.71	0	0	0	0
1062	Uniform Load	GZ	NO	0	-1	1	-1	0	0	0	0
1062	Uniform Load	GZ	NO	0	-2.25	1	-2.25	0	0	0	0
1062	Uniform Load	GZ	NO	0	-0.39	1	-0.39	0	0	0	0
1062	Uniform Load	GZ	NO	0	-2.6	1	-2.6	0	0	0	0
1062	Uniform Load	GZ	NO	0	-8.45	1	-8.45	0	0	0	0
1062	Uniform Load	GZ	NO	0	-6.6	1	-6.6	0	0	0	0
1063	Uniform Load	GZ	NO	0	-2.6	1	-2.6	0	0	0	0
1063	Uniform Load	GZ	NO	0	-2.25	1	-2.25	0	0	0	0
1063	Uniform Load	GZ	NO	0	-0.39	1	-0.39	0	0	0	0
1063	Uniform Load	GZ	NO	0	-0.71	1	-0.71	0	0	0	0
1063	Uniform Load	GZ	NO	0	-6.6	1	-6.6	0	0	0	0
1063	Uniform Load	GZ	NO	0	-8.45	1	-8.45	0	0	0	0
1063	Uniform Load	GZ	NO	0	-1	1	-1	0	0	0	0
1064	Uniform Load	GZ	NO	0	-6.6	1	-6.6	0	0	0	0
1064	Uniform Load	GZ	NO	0	-0.39	1	-0.39	0	0	0	0
1064	Uniform Load	GZ	NO	0	-2.6	1	-2.6	0	0	0	0
1064	Uniform Load	GZ	NO	0	-2.25	1	-2.25	0	0	0	0
1064	Uniform Load	GZ	NO	0	-8.45	1	-8.45	0	0	0	0
1064	Uniform Load	GZ	NO	0	-0.71	1	-0.71	0	0	0	0
1064	Uniform Load	GZ	NO	0	-1	1	-1	0	0	0	0
1065	Uniform Load	GZ	NO	0	-2.25	1	-2.25	0	0	0	0
1065	Uniform Load	GZ	NO	0	-8.45	1	-8.45	0	0	0	0
1065	Uniform Load	GZ	NO	0	-6.6	1	-6.6	0	0	0	0
1065	Uniform Load	GZ	NO	0	-2.6	1	-2.6	0	0	0	0
1065	Uniform Load	GZ	NO	0	-1	1	-1	0	0	0	0
1065	Uniform Load	GZ	NO	0	-0.71	1	-0.71	0	0	0	0
1065	Uniform Load	GZ	NO	0	-0.39	1	-0.39	0	0	0	0
1066	Uniform Load	GZ	NO	0	-2.6	1	-2.6	0	0	0	0
1066	Uniform Load	GZ	NO	0	-8.45	1	-8.45	0	0	0	0
1066	Uniform Load	GZ	NO	0	-2.25	1	-2.25	0	0	0	0
1066	Uniform Load	GZ	NO	0	-1	1	-1	0	0	0	0
1066	Uniform Load	GZ	NO	0	-6.6	1	-6.6	0	0	0	0
1066	Uniform Load	GZ	NO	0	-0.71	1	-0.71	0	0	0	0
1066	Uniform Load	GZ	NO	0	-0.39	1	-0.39	0	0	0	0
1067	Uniform Load	GZ	NO	0	-2.25	1	-2.25	0	0	0	0
1067	Uniform Load	GZ	NO	0	-8.45	1	-8.45	0	0	0	0
1067	Uniform Load	GZ	NO	0	-2.6	1	-2.6	0	0	0	0
1067	Uniform Load	GZ	NO	0	-6.6	1	-6.6	0	0	0	0
1067	Uniform Load	GZ	NO	0	-0.39	1	-0.39	0	0	0	0
1067	Uniform Load	GZ	NO	0	-1	1	-1	0	0	0	0
1067	Uniform Load	GZ	NO	0	-0.71	1	-0.71	0	0	0	0
1068	Uniform Load	GZ	NO	0	-6.6	1	-6.6	0	0	0	0
1068	Uniform Load	GZ	NO	0	-0.71	1	-0.71	0	0	0	0
1068	Uniform Load	GZ	NO	0	-1	1	-1	0	0	0	0
1068	Uniform Load	GZ	NO	0	-8.45	1	-8.45	0	0	0	0
1068	Uniform Load	GZ	NO	0	-2.6	1	-2.6	0	0	0	0
1068	Uniform Load	GZ	NO	0	-2.25	1	-2.25	0	0	0	0
1068	Uniform Load	GZ	NO	0	-0.39	1	-0.39	0	0	0	0
1069	Uniform Load	GZ	NO	0	-2.25	1	-2.25	0	0	0	0
1069	Uniform Load	GZ	NO	0	-2.6	1	-2.6	0	0	0	0
1069	Uniform Load	GZ	NO	0	-1	1	-1	0	0	0	0
1069	Uniform Load	GZ	NO	0	-0.71	1	-0.71	0	0	0	0
1069	Uniform Load	GZ	NO	0	-6.6	1	-6.6	0	0	0	0
1069	Uniform Load	GZ	NO	0	-8.45	1	-8.45	0	0	0	0
1069	Uniform Load	GZ	NO	0	-0.39	1	-0.39	0	0	0	0
1070	Uniform Load	GZ	NO	0	-8.45	1	-8.45	0	0	0	0
1070	Uniform Load	GZ	NO	0	-6.6	1	-6.6	0	0	0	0
1070	Uniform Load	GZ	NO	0	-0.71	1	-0.71	0	0	0	0

Sovrapasso di ingresso - Ponte strallato - Relazione di calcolo

1070	Uniform Load	GZ	NO	0	-2.6	1	-2.6	0	0	0	0
1070	Uniform Load	GZ	NO	0	-0.39	1	-0.39	0	0	0	0
1070	Uniform Load	GZ	NO	0	-2.25	1	-2.25	0	0	0	0
1070	Uniform Load	GZ	NO	0	-1	1	-1	0	0	0	0
1071	Uniform Load	GZ	NO	0	-0.39	1	-0.39	0	0	0	0
1071	Uniform Load	GZ	NO	0	-1	1	-1	0	0	0	0
1071	Uniform Load	GZ	NO	0	-2.25	1	-2.25	0	0	0	0
1071	Uniform Load	GZ	NO	0	-2.6	1	-2.6	0	0	0	0
1071	Uniform Load	GZ	NO	0	-0.71	1	-0.71	0	0	0	0
1071	Uniform Load	GZ	NO	0	-6.6	1	-6.6	0	0	0	0
1071	Uniform Load	GZ	NO	0	-8.45	1	-8.45	0	0	0	0
1072	Uniform Load	GZ	NO	0	-2.6	1	-2.6	0	0	0	0
1072	Uniform Load	GZ	NO	0	-0.39	1	-0.39	0	0	0	0
1072	Uniform Load	GZ	NO	0	-0.71	1	-0.71	0	0	0	0
1072	Uniform Load	GZ	NO	0	-2.25	1	-2.25	0	0	0	0
1072	Uniform Load	GZ	NO	0	-8.45	1	-8.45	0	0	0	0
1072	Uniform Load	GZ	NO	0	-6.6	1	-6.6	0	0	0	0
1072	Uniform Load	GZ	NO	0	-1	1	-1	0	0	0	0
1073	Uniform Load	GZ	NO	0	-6.6	1	-6.6	0	0	0	0
1073	Uniform Load	GZ	NO	0	-8.45	1	-8.45	0	0	0	0
1073	Uniform Load	GZ	NO	0	-1	1	-1	0	0	0	0
1073	Uniform Load	GZ	NO	0	-2.6	1	-2.6	0	0	0	0
1073	Uniform Load	GZ	NO	0	-2.25	1	-2.25	0	0	0	0
1073	Uniform Load	GZ	NO	0	-0.71	1	-0.71	0	0	0	0
1073	Uniform Load	GZ	NO	0	-0.39	1	-0.39	0	0	0	0
1074	Uniform Load	GZ	NO	0	-6.6	1	-6.6	0	0	0	0
1074	Uniform Load	GZ	NO	0	-1	1	-1	0	0	0	0
1074	Uniform Load	GZ	NO	0	-0.39	1	-0.39	0	0	0	0
1074	Uniform Load	GZ	NO	0	-8.45	1	-8.45	0	0	0	0
1074	Uniform Load	GZ	NO	0	-2.25	1	-2.25	0	0	0	0
1074	Uniform Load	GZ	NO	0	-2.6	1	-2.6	0	0	0	0
1074	Uniform Load	GZ	NO	0	-0.71	1	-0.71	0	0	0	0
1075	Uniform Load	GZ	NO	0	-1	1	-1	0	0	0	0
1075	Uniform Load	GZ	NO	0	-0.39	1	-0.39	0	0	0	0
1075	Uniform Load	GZ	NO	0	-2.6	1	-2.6	0	0	0	0
1075	Uniform Load	GZ	NO	0	-0.71	1	-0.71	0	0	0	0
1075	Uniform Load	GZ	NO	0	-8.45	1	-8.45	0	0	0	0
1075	Uniform Load	GZ	NO	0	-6.6	1	-6.6	0	0	0	0
1075	Uniform Load	GZ	NO	0	-2.25	1	-2.25	0	0	0	0
1076	Uniform Load	GZ	NO	0	-1	1	-1	0	0	0	0
1076	Uniform Load	GZ	NO	0	-2.25	1	-2.25	0	0	0	0
1076	Uniform Load	GZ	NO	0	-0.39	1	-0.39	0	0	0	0
1076	Uniform Load	GZ	NO	0	-8.45	1	-8.45	0	0	0	0
1076	Uniform Load	GZ	NO	0	-2.6	1	-2.6	0	0	0	0
1076	Uniform Load	GZ	NO	0	-6.6	1	-6.6	0	0	0	0
1076	Uniform Load	GZ	NO	0	-0.71	1	-0.71	0	0	0	0
1077	Uniform Load	GZ	NO	0	-8.45	1	-8.45	0	0	0	0
1077	Uniform Load	GZ	NO	0	-0.39	1	-0.39	0	0	0	0
1077	Uniform Load	GZ	NO	0	-2.25	1	-2.25	0	0	0	0
1077	Uniform Load	GZ	NO	0	-6.6	1	-6.6	0	0	0	0
1077	Uniform Load	GZ	NO	0	-0.71	1	-0.71	0	0	0	0
1077	Uniform Load	GZ	NO	0	-1	1	-1	0	0	0	0
1077	Uniform Load	GZ	NO	0	-2.6	1	-2.6	0	0	0	0
1078	Uniform Load	GZ	NO	0	-6.6	1	-6.6	0	0	0	0
1078	Uniform Load	GZ	NO	0	-0.39	1	-0.39	0	0	0	0
1078	Uniform Load	GZ	NO	0	-2.6	1	-2.6	0	0	0	0
1078	Uniform Load	GZ	NO	0	-1	1	-1	0	0	0	0
1078	Uniform Load	GZ	NO	0	-8.45	1	-8.45	0	0	0	0
1078	Uniform Load	GZ	NO	0	-2.25	1	-2.25	0	0	0	0
1078	Uniform Load	GZ	NO	0	-0.71	1	-0.71	0	0	0	0
1079	Uniform Load	GZ	NO	0	-2.6	1	-2.6	0	0	0	0
1079	Uniform Load	GZ	NO	0	-2.25	1	-2.25	0	0	0	0
1079	Uniform Load	GZ	NO	0	-0.71	1	-0.71	0	0	0	0
1079	Uniform Load	GZ	NO	0	-0.39	1	-0.39	0	0	0	0
1079	Uniform Load	GZ	NO	0	-6.6	1	-6.6	0	0	0	0
1079	Uniform Load	GZ	NO	0	-8.45	1	-8.45	0	0	0	0
1079	Uniform Load	GZ	NO	0	-1	1	-1	0	0	0	0
1080	Uniform Load	GZ	NO	0	-6.6	1	-6.6	0	0	0	0
1080	Uniform Load	GZ	NO	0	-1	1	-1	0	0	0	0
1080	Uniform Load	GZ	NO	0	-0.39	1	-0.39	0	0	0	0
1080	Uniform Load	GZ	NO	0	-0.71	1	-0.71	0	0	0	0
1080	Uniform Load	GZ	NO	0	-8.45	1	-8.45	0	0	0	0
1080	Uniform Load	GZ	NO	0	-2.25	1	-2.25	0	0	0	0
1080	Uniform Load	GZ	NO	0	-2.6	1	-2.6	0	0	0	0
1081	Uniform Load	GZ	NO	0	-8.45	1	-8.45	0	0	0	0
1081	Uniform Load	GZ	NO	0	-2.25	1	-2.25	0	0	0	0
1081	Uniform Load	GZ	NO	0	-0.39	1	-0.39	0	0	0	0
1081	Uniform Load	GZ	NO	0	-0.71	1	-0.71	0	0	0	0
1081	Uniform Load	GZ	NO	0	-1	1	-1	0	0	0	0
1081	Uniform Load	GZ	NO	0	-6.6	1	-6.6	0	0	0	0
1081	Uniform Load	GZ	NO	0	-2.6	1	-2.6	0	0	0	0
1082	Uniform Load	GZ	NO	0	-8.45	1	-8.45	0	0	0	0
1082	Uniform Load	GZ	NO	0	-1	1	-1	0	0	0	0
1082	Uniform Load	GZ	NO	0	-2.6	1	-2.6	0	0	0	0
1082	Uniform Load	GZ	NO	0	-0.39	1	-0.39	0	0	0	0
1082	Uniform Load	GZ	NO	0	-2.25	1	-2.25	0	0	0	0
1082	Uniform Load	GZ	NO	0	-6.6	1	-6.6	0	0	0	0
1082	Uniform Load	GZ	NO	0	-0.71	1	-0.71	0	0	0	0
1083	Uniform Load	GZ	NO	0	-0.39	1	-0.39	0	0	0	0
1083	Uniform Load	GZ	NO	0	-2.6	1	-2.6	0	0	0	0
1083	Uniform Load	GZ	NO	0	-2.25	1	-2.25	0	0	0	0
1083	Uniform Load	GZ	NO	0	-8.45	1	-8.45	0	0	0	0
1083	Uniform Load	GZ	NO	0	-1	1	-1	0	0	0	0
1083	Uniform Load	GZ	NO	0	-0.71	1	-0.71	0	0	0	0
1083	Uniform Load	GZ	NO	0	-6.6	1	-6.6	0	0	0	0
1084	Uniform Load	GZ	NO	0	-0.39	1	-0.39	0	0	0	0
1084	Uniform Load	GZ	NO	0	-1	1	-1	0	0	0	0
1084	Uniform Load	GZ	NO	0	-0.71	1	-0.71	0	0	0	0
1084	Uniform Load	GZ	NO	0	-2.25	1	-2.25	0	0	0	0
1084	Uniform Load	GZ	NO	0	-8.45	1	-8.45	0	0	0	0

Sovrapasso di ingresso - Ponte strallato - Relazione di calcolo

1084	Uniform Load	GZ	NO	0	-2.6	1	-2.6	0	0	0	0
1084	Uniform Load	GZ	NO	0	-6.6	1	-6.6	0	0	0	0
1085	Uniform Load	GZ	NO	0	-6.6	1	-6.6	0	0	0	0
1085	Uniform Load	GZ	NO	0	-1	1	-1	0	0	0	0
1085	Uniform Load	GZ	NO	0	-2.25	1	-2.25	0	0	0	0
1085	Uniform Load	GZ	NO	0	-0.71	1	-0.71	0	0	0	0
1085	Uniform Load	GZ	NO	0	-0.39	1	-0.39	0	0	0	0
1085	Uniform Load	GZ	NO	0	-8.45	1	-8.45	0	0	0	0
1085	Uniform Load	GZ	NO	0	-2.6	1	-2.6	0	0	0	0
1086	Uniform Load	GZ	NO	0	-6.6	1	-6.6	0	0	0	0
1086	Uniform Load	GZ	NO	0	-2.25	1	-2.25	0	0	0	0
1086	Uniform Load	GZ	NO	0	-2.6	1	-2.6	0	0	0	0
1086	Uniform Load	GZ	NO	0	-0.39	1	-0.39	0	0	0	0
1086	Uniform Load	GZ	NO	0	-1	1	-1	0	0	0	0
1086	Uniform Load	GZ	NO	0	-8.45	1	-8.45	0	0	0	0
1086	Uniform Load	GZ	NO	0	-0.71	1	-0.71	0	0	0	0
1087	Uniform Load	GZ	NO	0	-0.71	1	-0.71	0	0	0	0
1087	Uniform Load	GZ	NO	0	-8.45	1	-8.45	0	0	0	0
1087	Uniform Load	GZ	NO	0	-0.39	1	-0.39	0	0	0	0
1087	Uniform Load	GZ	NO	0	-6.6	1	-6.6	0	0	0	0
1087	Uniform Load	GZ	NO	0	-1	1	-1	0	0	0	0
1087	Uniform Load	GZ	NO	0	-2.6	1	-2.6	0	0	0	0
1087	Uniform Load	GZ	NO	0	-2.25	1	-2.25	0	0	0	0
1088	Uniform Load	GZ	NO	0	-8.45	1	-8.45	0	0	0	0
1088	Uniform Load	GZ	NO	0	-1	1	-1	0	0	0	0
1088	Uniform Load	GZ	NO	0	-0.71	1	-0.71	0	0	0	0
1088	Uniform Load	GZ	NO	0	-2.25	1	-2.25	0	0	0	0
1088	Uniform Load	GZ	NO	0	-2.6	1	-2.6	0	0	0	0
1088	Uniform Load	GZ	NO	0	-6.6	1	-6.6	0	0	0	0
1088	Uniform Load	GZ	NO	0	-0.39	1	-0.39	0	0	0	0
1089	Uniform Load	GZ	NO	0	-0.71	1	-0.71	0	0	0	0
1089	Uniform Load	GZ	NO	0	-2.6	1	-2.6	0	0	0	0
1089	Uniform Load	GZ	NO	0	-2.25	1	-2.25	0	0	0	0
1089	Uniform Load	GZ	NO	0	-6.6	1	-6.6	0	0	0	0
1089	Uniform Load	GZ	NO	0	-1	1	-1	0	0	0	0
1089	Uniform Load	GZ	NO	0	-0.39	1	-0.39	0	0	0	0
1089	Uniform Load	GZ	NO	0	-8.45	1	-8.45	0	0	0	0
1090	Uniform Load	GZ	NO	0	-6.6	1	-6.6	0	0	0	0
1090	Uniform Load	GZ	NO	0	-1	1	-1	0	0	0	0
1090	Uniform Load	GZ	NO	0	-2.6	1	-2.6	0	0	0	0
1090	Uniform Load	GZ	NO	0	-8.45	1	-8.45	0	0	0	0
1090	Uniform Load	GZ	NO	0	-0.39	1	-0.39	0	0	0	0
1090	Uniform Load	GZ	NO	0	-2.25	1	-2.25	0	0	0	0
1090	Uniform Load	GZ	NO	0	-0.71	1	-0.71	0	0	0	0
1091	Uniform Load	GZ	NO	0	-8.45	1	-8.45	0	0	0	0
1091	Uniform Load	GZ	NO	0	-6.6	1	-6.6	0	0	0	0
1091	Uniform Load	GZ	NO	0	-2.25	1	-2.25	0	0	0	0
1091	Uniform Load	GZ	NO	0	-1	1	-1	0	0	0	0
1091	Uniform Load	GZ	NO	0	-2.6	1	-2.6	0	0	0	0
1091	Uniform Load	GZ	NO	0	-0.39	1	-0.39	0	0	0	0
1091	Uniform Load	GZ	NO	0	-0.71	1	-0.71	0	0	0	0
1092	Uniform Load	GZ	NO	0	-6.6	1	-6.6	0	0	0	0
1092	Uniform Load	GZ	NO	0	-0.39	1	-0.39	0	0	0	0
1092	Uniform Load	GZ	NO	0	-1	1	-1	0	0	0	0
1092	Uniform Load	GZ	NO	0	-0.71	1	-0.71	0	0	0	0
1092	Uniform Load	GZ	NO	0	-2.6	1	-2.6	0	0	0	0
1092	Uniform Load	GZ	NO	0	-2.25	1	-2.25	0	0	0	0
1092	Uniform Load	GZ	NO	0	-8.45	1	-8.45	0	0	0	0
1093	Uniform Load	GZ	NO	0	-2.25	1	-2.25	0	0	0	0
1093	Uniform Load	GZ	NO	0	-0.71	1	-0.71	0	0	0	0
1093	Uniform Load	GZ	NO	0	-2.6	1	-2.6	0	0	0	0
1093	Uniform Load	GZ	NO	0	-1	1	-1	0	0	0	0
1093	Uniform Load	GZ	NO	0	-8.45	1	-8.45	0	0	0	0
1093	Uniform Load	GZ	NO	0	-6.6	1	-6.6	0	0	0	0
1093	Uniform Load	GZ	NO	0	-0.39	1	-0.39	0	0	0	0
1094	Uniform Load	GZ	NO	0	-6.6	1	-6.6	0	0	0	0
1094	Uniform Load	GZ	NO	0	-2.25	1	-2.25	0	0	0	0
1094	Uniform Load	GZ	NO	0	-8.45	1	-8.45	0	0	0	0
1094	Uniform Load	GZ	NO	0	-1	1	-1	0	0	0	0
1094	Uniform Load	GZ	NO	0	-2.6	1	-2.6	0	0	0	0
1094	Uniform Load	GZ	NO	0	-0.71	1	-0.71	0	0	0	0
1094	Uniform Load	GZ	NO	0	-0.39	1	-0.39	0	0	0	0
1095	Uniform Load	GZ	NO	0	-0.71	1	-0.71	0	0	0	0
1095	Uniform Load	GZ	NO	0	-0.39	1	-0.39	0	0	0	0
1095	Uniform Load	GZ	NO	0	-1	1	-1	0	0	0	0
1095	Uniform Load	GZ	NO	0	-6.6	1	-6.6	0	0	0	0
1095	Uniform Load	GZ	NO	0	-2.25	1	-2.25	0	0	0	0
1095	Uniform Load	GZ	NO	0	-2.6	1	-2.6	0	0	0	0
1095	Uniform Load	GZ	NO	0	-8.45	1	-8.45	0	0	0	0
1096	Uniform Load	GZ	NO	0	-8.45	1	-8.45	0	0	0	0
1096	Uniform Load	GZ	NO	0	-1	1	-1	0	0	0	0
1096	Uniform Load	GZ	NO	0	-2.25	1	-2.25	0	0	0	0
1096	Uniform Load	GZ	NO	0	-0.71	1	-0.71	0	0	0	0
1096	Uniform Load	GZ	NO	0	-2.6	1	-2.6	0	0	0	0
1096	Uniform Load	GZ	NO	0	-0.39	1	-0.39	0	0	0	0
1096	Uniform Load	GZ	NO	0	-6.6	1	-6.6	0	0	0	0
1097	Uniform Load	GZ	NO	0	-0.39	1	-0.39	0	0	0	0
1097	Uniform Load	GZ	NO	0	-1	1	-1	0	0	0	0
1097	Uniform Load	GZ	NO	0	-2.25	1	-2.25	0	0	0	0
1097	Uniform Load	GZ	NO	0	-0.71	1	-0.71	0	0	0	0
1097	Uniform Load	GZ	NO	0	-6.6	1	-6.6	0	0	0	0
1097	Uniform Load	GZ	NO	0	-2.6	1	-2.6	0	0	0	0
1097	Uniform Load	GZ	NO	0	-8.45	1	-8.45	0	0	0	0
1098	Uniform Load	GZ	NO	0	-8.45	1	-8.45	0	0	0	0
1098	Uniform Load	GZ	NO	0	-2.6	1	-2.6	0	0	0	0
1098	Uniform Load	GZ	NO	0	-2.25	1	-2.25	0	0	0	0
1098	Uniform Load	GZ	NO	0	-1	1	-1	0	0	0	0
1098	Uniform Load	GZ	NO	0	-0.39	1	-0.39	0	0	0	0
1098	Uniform Load	GZ	NO	0	-6.6	1	-6.6	0	0	0	0
1098	Uniform Load	GZ	NO	0	-0.71	1	-0.71	0	0	0	0

Sovrapasso di ingresso - Ponte strallato - Relazione di calcolo

1099	Uniform Load	GZ	NO	0	-1	1	-1	0	0	0	0
1099	Uniform Load	GZ	NO	0	-6.6	1	-6.6	0	0	0	0
1099	Uniform Load	GZ	NO	0	-0.71	1	-0.71	0	0	0	0
1099	Uniform Load	GZ	NO	0	-2.6	1	-2.6	0	0	0	0
1099	Uniform Load	GZ	NO	0	-2.25	1	-2.25	0	0	0	0
1099	Uniform Load	GZ	NO	0	-0.39	1	-0.39	0	0	0	0
1099	Uniform Load	GZ	NO	0	-8.45	1	-8.45	0	0	0	0
1100	Uniform Load	GZ	NO	0	-8.45	1	-8.45	0	0	0	0
1100	Uniform Load	GZ	NO	0	-0.39	1	-0.39	0	0	0	0
1100	Uniform Load	GZ	NO	0	-2.6	1	-2.6	0	0	0	0
1100	Uniform Load	GZ	NO	0	-6.6	1	-6.6	0	0	0	0
1100	Uniform Load	GZ	NO	0	-2.25	1	-2.25	0	0	0	0
1100	Uniform Load	GZ	NO	0	-0.71	1	-0.71	0	0	0	0
1100	Uniform Load	GZ	NO	0	-1	1	-1	0	0	0	0
1101	Uniform Load	GZ	NO	0	-0.71	1	-0.71	0	0	0	0
1101	Uniform Load	GZ	NO	0	-8.45	1	-8.45	0	0	0	0
1101	Uniform Load	GZ	NO	0	-1	1	-1	0	0	0	0
1101	Uniform Load	GZ	NO	0	-2.25	1	-2.25	0	0	0	0
1101	Uniform Load	GZ	NO	0	-2.6	1	-2.6	0	0	0	0
1101	Uniform Load	GZ	NO	0	-0.39	1	-0.39	0	0	0	0
1101	Uniform Load	GZ	NO	0	-6.6	1	-6.6	0	0	0	0
1102	Uniform Load	GZ	NO	0	-6.6	1	-6.6	0	0	0	0
1102	Uniform Load	GZ	NO	0	-0.39	1	-0.39	0	0	0	0
1102	Uniform Load	GZ	NO	0	-0.71	1	-0.71	0	0	0	0
1102	Uniform Load	GZ	NO	0	-8.45	1	-8.45	0	0	0	0
1102	Uniform Load	GZ	NO	0	-1	1	-1	0	0	0	0
1102	Uniform Load	GZ	NO	0	-2.6	1	-2.6	0	0	0	0
1102	Uniform Load	GZ	NO	0	-2.25	1	-2.25	0	0	0	0
1103	Uniform Load	GZ	NO	0	-0.71	1	-0.71	0	0	0	0
1103	Uniform Load	GZ	NO	0	-0.39	1	-0.39	0	0	0	0
1103	Uniform Load	GZ	NO	0	-2.6	1	-2.6	0	0	0	0
1103	Uniform Load	GZ	NO	0	-8.45	1	-8.45	0	0	0	0
1103	Uniform Load	GZ	NO	0	-1	1	-1	0	0	0	0
1103	Uniform Load	GZ	NO	0	-2.25	1	-2.25	0	0	0	0
1103	Uniform Load	GZ	NO	0	-6.6	1	-6.6	0	0	0	0
1104	Uniform Load	GZ	NO	0	-2.25	1	-2.25	0	0	0	0
1104	Uniform Load	GZ	NO	0	-2.6	1	-2.6	0	0	0	0
1104	Uniform Load	GZ	NO	0	-8.45	1	-8.45	0	0	0	0
1104	Uniform Load	GZ	NO	0	-1	1	-1	0	0	0	0
1104	Uniform Load	GZ	NO	0	-6.6	1	-6.6	0	0	0	0
1104	Uniform Load	GZ	NO	0	-0.71	1	-0.71	0	0	0	0
1104	Uniform Load	GZ	NO	0	-0.39	1	-0.39	0	0	0	0
1105	Uniform Load	GZ	NO	0	-2.6	1	-2.6	0	0	0	0
1105	Uniform Load	GZ	NO	0	-1	1	-1	0	0	0	0
1105	Uniform Load	GZ	NO	0	-8.45	1	-8.45	0	0	0	0
1105	Uniform Load	GZ	NO	0	-0.71	1	-0.71	0	0	0	0
1105	Uniform Load	GZ	NO	0	-6.6	1	-6.6	0	0	0	0
1105	Uniform Load	GZ	NO	0	-0.39	1	-0.39	0	0	0	0
1105	Uniform Load	GZ	NO	0	-2.25	1	-2.25	0	0	0	0
1106	Uniform Load	GZ	NO	0	-2.25	1	-2.25	0	0	0	0
1106	Uniform Load	GZ	NO	0	-8.45	1	-8.45	0	0	0	0
1106	Uniform Load	GZ	NO	0	-2.6	1	-2.6	0	0	0	0
1106	Uniform Load	GZ	NO	0	-6.6	1	-6.6	0	0	0	0
1106	Uniform Load	GZ	NO	0	-1	1	-1	0	0	0	0
1106	Uniform Load	GZ	NO	0	-0.71	1	-0.71	0	0	0	0
1106	Uniform Load	GZ	NO	0	-0.39	1	-0.39	0	0	0	0
1107	Uniform Load	GZ	NO	0	-0.71	1	-0.71	0	0	0	0
1107	Uniform Load	GZ	NO	0	-1	1	-1	0	0	0	0
1107	Uniform Load	GZ	NO	0	-0.39	1	-0.39	0	0	0	0
1107	Uniform Load	GZ	NO	0	-2.6	1	-2.6	0	0	0	0
1107	Uniform Load	GZ	NO	0	-2.25	1	-2.25	0	0	0	0
1107	Uniform Load	GZ	NO	0	-6.6	1	-6.6	0	0	0	0
1107	Uniform Load	GZ	NO	0	-8.45	1	-8.45	0	0	0	0
1108	Uniform Load	GZ	NO	0	-0.71	1	-0.71	0	0	0	0
1108	Uniform Load	GZ	NO	0	-0.39	1	-0.39	0	0	0	0
1108	Uniform Load	GZ	NO	0	-2.25	1	-2.25	0	0	0	0
1108	Uniform Load	GZ	NO	0	-8.45	1	-8.45	0	0	0	0
1108	Uniform Load	GZ	NO	0	-1	1	-1	0	0	0	0
1108	Uniform Load	GZ	NO	0	-2.6	1	-2.6	0	0	0	0
1108	Uniform Load	GZ	NO	0	-6.6	1	-6.6	0	0	0	0
1109	Uniform Load	GZ	NO	0	-2.6	1	-2.6	0	0	0	0
1109	Uniform Load	GZ	NO	0	-0.71	1	-0.71	0	0	0	0
1109	Uniform Load	GZ	NO	0	-1	1	-1	0	0	0	0
1109	Uniform Load	GZ	NO	0	-2.25	1	-2.25	0	0	0	0
1109	Uniform Load	GZ	NO	0	-8.45	1	-8.45	0	0	0	0
1109	Uniform Load	GZ	NO	0	-0.39	1	-0.39	0	0	0	0
1109	Uniform Load	GZ	NO	0	-6.6	1	-6.6	0	0	0	0
1110	Uniform Load	GZ	NO	0	-6.6	1	-6.6	0	0	0	0
1110	Uniform Load	GZ	NO	0	-0.71	1	-0.71	0	0	0	0
1110	Uniform Load	GZ	NO	0	-2.25	1	-2.25	0	0	0	0
1110	Uniform Load	GZ	NO	0	-0.39	1	-0.39	0	0	0	0
1110	Uniform Load	GZ	NO	0	-8.45	1	-8.45	0	0	0	0
1110	Uniform Load	GZ	NO	0	-1	1	-1	0	0	0	0
1110	Uniform Load	GZ	NO	0	-2.6	1	-2.6	0	0	0	0
1111	Uniform Load	GZ	NO	0	-2.6	1	-2.6	0	0	0	0
1111	Uniform Load	GZ	NO	0	-1	1	-1	0	0	0	0
1111	Uniform Load	GZ	NO	0	-6.6	1	-6.6	0	0	0	0
1111	Uniform Load	GZ	NO	0	-8.45	1	-8.45	0	0	0	0
1111	Uniform Load	GZ	NO	0	-0.39	1	-0.39	0	0	0	0
1111	Uniform Load	GZ	NO	0	-0.71	1	-0.71	0	0	0	0
1111	Uniform Load	GZ	NO	0	-2.25	1	-2.25	0	0	0	0
1112	Uniform Load	GZ	NO	0	-6.6	1	-6.6	0	0	0	0
1112	Uniform Load	GZ	NO	0	-0.71	1	-0.71	0	0	0	0
1112	Uniform Load	GZ	NO	0	-2.25	1	-2.25	0	0	0	0
1112	Uniform Load	GZ	NO	0	-1	1	-1	0	0	0	0
1112	Uniform Load	GZ	NO	0	-2.6	1	-2.6	0	0	0	0
1112	Uniform Load	GZ	NO	0	-0.39	1	-0.39	0	0	0	0
1112	Uniform Load	GZ	NO	0	-8.45	1	-8.45	0	0	0	0
1113	Uniform Load	GZ	NO	0	-0.71	1	-0.71	0	0	0	0
1113	Uniform Load	GZ	NO	0	-0.39	1	-0.39	0	0	0	0

Sovrapasso di ingresso - Ponte strallato - Relazione di calcolo

1113	Uniform Load	GZ	NO	0	-2.6	1	-2.6	0	0	0	0
1113	Uniform Load	GZ	NO	0	-8.45	1	-8.45	0	0	0	0
1113	Uniform Load	GZ	NO	0	-2.25	1	-2.25	0	0	0	0
1113	Uniform Load	GZ	NO	0	-1	1	-1	0	0	0	0
1113	Uniform Load	GZ	NO	0	-6.6	1	-6.6	0	0	0	0
1114	Uniform Load	GZ	NO	0	-1	1	-1	0	0	0	0
1114	Uniform Load	GZ	NO	0	-8.45	1	-8.45	0	0	0	0
1114	Uniform Load	GZ	NO	0	-2.6	1	-2.6	0	0	0	0
1114	Uniform Load	GZ	NO	0	-0.71	1	-0.71	0	0	0	0
1114	Uniform Load	GZ	NO	0	-2.25	1	-2.25	0	0	0	0
1114	Uniform Load	GZ	NO	0	-6.6	1	-6.6	0	0	0	0
1114	Uniform Load	GZ	NO	0	-0.39	1	-0.39	0	0	0	0
1115	Uniform Load	GZ	NO	0	-2.25	1	-2.25	0	0	0	0
1115	Uniform Load	GZ	NO	0	-0.39	1	-0.39	0	0	0	0
1115	Uniform Load	GZ	NO	0	-1	1	-1	0	0	0	0
1115	Uniform Load	GZ	NO	0	-8.45	1	-8.45	0	0	0	0
1115	Uniform Load	GZ	NO	0	-6.6	1	-6.6	0	0	0	0
1115	Uniform Load	GZ	NO	0	-2.6	1	-2.6	0	0	0	0
1115	Uniform Load	GZ	NO	0	-0.71	1	-0.71	0	0	0	0
1116	Uniform Load	GZ	NO	0	-8.45	1	-8.45	0	0	0	0
1116	Uniform Load	GZ	NO	0	-6.6	1	-6.6	0	0	0	0
1116	Uniform Load	GZ	NO	0	-2.25	1	-2.25	0	0	0	0
1116	Uniform Load	GZ	NO	0	-0.39	1	-0.39	0	0	0	0
1116	Uniform Load	GZ	NO	0	-2.6	1	-2.6	0	0	0	0
1116	Uniform Load	GZ	NO	0	-1	1	-1	0	0	0	0
1116	Uniform Load	GZ	NO	0	-0.71	1	-0.71	0	0	0	0
1117	Uniform Load	GZ	NO	0	-1	1	-1	0	0	0	0
1117	Uniform Load	GZ	NO	0	-2.25	1	-2.25	0	0	0	0
1117	Uniform Load	GZ	NO	0	-0.39	1	-0.39	0	0	0	0
1117	Uniform Load	GZ	NO	0	-8.45	1	-8.45	0	0	0	0
1117	Uniform Load	GZ	NO	0	-6.6	1	-6.6	0	0	0	0
1117	Uniform Load	GZ	NO	0	-0.71	1	-0.71	0	0	0	0
1117	Uniform Load	GZ	NO	0	-2.6	1	-2.6	0	0	0	0
1118	Uniform Load	GZ	NO	0	-1	1	-1	0	0	0	0
1118	Uniform Load	GZ	NO	0	-2.6	1	-2.6	0	0	0	0
1118	Uniform Load	GZ	NO	0	-8.45	1	-8.45	0	0	0	0
1118	Uniform Load	GZ	NO	0	-0.71	1	-0.71	0	0	0	0
1118	Uniform Load	GZ	NO	0	-0.39	1	-0.39	0	0	0	0
1118	Uniform Load	GZ	NO	0	-2.25	1	-2.25	0	0	0	0
1118	Uniform Load	GZ	NO	0	-6.6	1	-6.6	0	0	0	0
1119	Uniform Load	GZ	NO	0	-0.71	1	-0.71	0	0	0	0
1119	Uniform Load	GZ	NO	0	-2.25	1	-2.25	0	0	0	0
1119	Uniform Load	GZ	NO	0	-0.39	1	-0.39	0	0	0	0
1119	Uniform Load	GZ	NO	0	-1	1	-1	0	0	0	0
1119	Uniform Load	GZ	NO	0	-6.6	1	-6.6	0	0	0	0
1119	Uniform Load	GZ	NO	0	-2.6	1	-2.6	0	0	0	0
1119	Uniform Load	GZ	NO	0	-8.45	1	-8.45	0	0	0	0
1120	Uniform Load	GZ	NO	0	-0.39	1	-0.39	0	0	0	0
1120	Uniform Load	GZ	NO	0	-2.25	1	-2.25	0	0	0	0
1120	Uniform Load	GZ	NO	0	-2.6	1	-2.6	0	0	0	0
1120	Uniform Load	GZ	NO	0	-6.6	1	-6.6	0	0	0	0
1120	Uniform Load	GZ	NO	0	-1	1	-1	0	0	0	0
1120	Uniform Load	GZ	NO	0	-0.71	1	-0.71	0	0	0	0
1120	Uniform Load	GZ	NO	0	-8.45	1	-8.45	0	0	0	0
1121	Uniform Load	GZ	NO	0	-8.45	1	-8.45	0	0	0	0
1121	Uniform Load	GZ	NO	0	-2.6	1	-2.6	0	0	0	0
1121	Uniform Load	GZ	NO	0	-6.6	1	-6.6	0	0	0	0
1121	Uniform Load	GZ	NO	0	-0.39	1	-0.39	0	0	0	0
1121	Uniform Load	GZ	NO	0	-2.25	1	-2.25	0	0	0	0
1121	Uniform Load	GZ	NO	0	-0.71	1	-0.71	0	0	0	0
1121	Uniform Load	GZ	NO	0	-1	1	-1	0	0	0	0
1122	Uniform Load	GZ	NO	0	-6.6	1	-6.6	0	0	0	0
1122	Uniform Load	GZ	NO	0	-0.39	1	-0.39	0	0	0	0
1122	Uniform Load	GZ	NO	0	-8.45	1	-8.45	0	0	0	0
1122	Uniform Load	GZ	NO	0	-0.71	1	-0.71	0	0	0	0
1122	Uniform Load	GZ	NO	0	-2.25	1	-2.25	0	0	0	0
1122	Uniform Load	GZ	NO	0	-1	1	-1	0	0	0	0
1122	Uniform Load	GZ	NO	0	-2.6	1	-2.6	0	0	0	0
1123	Uniform Load	GZ	NO	0	-2.25	1	-2.25	0	0	0	0
1123	Uniform Load	GZ	NO	0	-1	1	-1	0	0	0	0
1123	Uniform Load	GZ	NO	0	-2.6	1	-2.6	0	0	0	0
1123	Uniform Load	GZ	NO	0	-0.39	1	-0.39	0	0	0	0
1123	Uniform Load	GZ	NO	0	-6.6	1	-6.6	0	0	0	0
1123	Uniform Load	GZ	NO	0	-0.71	1	-0.71	0	0	0	0
1123	Uniform Load	GZ	NO	0	-8.45	1	-8.45	0	0	0	0
1124	Uniform Load	GZ	NO	0	-0.39	1	-0.39	0	0	0	0
1124	Uniform Load	GZ	NO	0	-2.6	1	-2.6	0	0	0	0
1124	Uniform Load	GZ	NO	0	-0.71	1	-0.71	0	0	0	0
1124	Uniform Load	GZ	NO	0	-2.25	1	-2.25	0	0	0	0
1124	Uniform Load	GZ	NO	0	-8.45	1	-8.45	0	0	0	0
1124	Uniform Load	GZ	NO	0	-6.6	1	-6.6	0	0	0	0
1124	Uniform Load	GZ	NO	0	-1	1	-1	0	0	0	0
1125	Uniform Load	GZ	NO	0	-6.6	1	-6.6	0	0	0	0
1125	Uniform Load	GZ	NO	0	-8.45	1	-8.45	0	0	0	0
1125	Uniform Load	GZ	NO	0	-1	1	-1	0	0	0	0
1125	Uniform Load	GZ	NO	0	-0.71	1	-0.71	0	0	0	0
1125	Uniform Load	GZ	NO	0	-2.25	1	-2.25	0	0	0	0
1125	Uniform Load	GZ	NO	0	-2.6	1	-2.6	0	0	0	0
1125	Uniform Load	GZ	NO	0	-0.39	1	-0.39	0	0	0	0
1126	Uniform Load	GZ	NO	0	-0.39	1	-0.39	0	0	0	0
1126	Uniform Load	GZ	NO	0	-1	1	-1	0	0	0	0
1126	Uniform Load	GZ	NO	0	-8.45	1	-8.45	0	0	0	0
1126	Uniform Load	GZ	NO	0	-0.71	1	-0.71	0	0	0	0
1126	Uniform Load	GZ	NO	0	-2.6	1	-2.6	0	0	0	0
1126	Uniform Load	GZ	NO	0	-6.6	1	-6.6	0	0	0	0
1126	Uniform Load	GZ	NO	0	-2.25	1	-2.25	0	0	0	0
1127	Uniform Load	GZ	NO	0	-8.45	1	-8.45	0	0	0	0
1127	Uniform Load	GZ	NO	0	-0.71	1	-0.71	0	0	0	0
1127	Uniform Load	GZ	NO	0	-2.25	1	-2.25	0	0	0	0
1127	Uniform Load	GZ	NO	0	-0.39	1	-0.39	0	0	0	0

Sovrapasso di ingresso - Ponte strallato - Relazione di calcolo

1127	Uniform Load	GZ	NO	0	-2.6	1	-2.6	0	0	0	0
1127	Uniform Load	GZ	NO	0	-6.6	1	-6.6	0	0	0	0
1127	Uniform Load	GZ	NO	0	-1	1	-1	0	0	0	0
1128	Uniform Load	GZ	NO	0	-2.6	1	-2.6	0	0	0	0
1128	Uniform Load	GZ	NO	0	-6.6	1	-6.6	0	0	0	0
1128	Uniform Load	GZ	NO	0	-0.39	1	-0.39	0	0	0	0
1128	Uniform Load	GZ	NO	0	-1	1	-1	0	0	0	0
1128	Uniform Load	GZ	NO	0	-2.25	1	-2.25	0	0	0	0
1128	Uniform Load	GZ	NO	0	-8.45	1	-8.45	0	0	0	0
1128	Uniform Load	GZ	NO	0	-0.71	1	-0.71	0	0	0	0
1129	Uniform Load	GZ	NO	0	-0.39	1	-0.39	0	0	0	0
1129	Uniform Load	GZ	NO	0	-2.25	1	-2.25	0	0	0	0
1129	Uniform Load	GZ	NO	0	-1	1	-1	0	0	0	0
1129	Uniform Load	GZ	NO	0	-6.6	1	-6.6	0	0	0	0
1129	Uniform Load	GZ	NO	0	-8.45	1	-8.45	0	0	0	0
1129	Uniform Load	GZ	NO	0	-0.71	1	-0.71	0	0	0	0
1129	Uniform Load	GZ	NO	0	-2.6	1	-2.6	0	0	0	0
1130	Uniform Load	GZ	NO	0	-0.71	1	-0.71	0	0	0	0
1130	Uniform Load	GZ	NO	0	-2.6	1	-2.6	0	0	0	0
1130	Uniform Load	GZ	NO	0	-6.6	1	-6.6	0	0	0	0
1130	Uniform Load	GZ	NO	0	-0.39	1	-0.39	0	0	0	0
1130	Uniform Load	GZ	NO	0	-2.25	1	-2.25	0	0	0	0
1130	Uniform Load	GZ	NO	0	-8.45	1	-8.45	0	0	0	0
1130	Uniform Load	GZ	NO	0	-1	1	-1	0	0	0	0
1131	Uniform Load	GZ	NO	0	-8.45	1	-8.45	0	0	0	0
1131	Uniform Load	GZ	NO	0	-2.6	1	-2.6	0	0	0	0
1131	Uniform Load	GZ	NO	0	-2.25	1	-2.25	0	0	0	0
1131	Uniform Load	GZ	NO	0	-1	1	-1	0	0	0	0
1131	Uniform Load	GZ	NO	0	-0.71	1	-0.71	0	0	0	0
1131	Uniform Load	GZ	NO	0	-0.39	1	-0.39	0	0	0	0
1131	Uniform Load	GZ	NO	0	-6.6	1	-6.6	0	0	0	0
1132	Uniform Load	GZ	NO	0	-6.6	1	-6.6	0	0	0	0
1132	Uniform Load	GZ	NO	0	-2.6	1	-2.6	0	0	0	0
1132	Uniform Load	GZ	NO	0	-2.25	1	-2.25	0	0	0	0
1132	Uniform Load	GZ	NO	0	-0.71	1	-0.71	0	0	0	0
1132	Uniform Load	GZ	NO	0	-1	1	-1	0	0	0	0
1132	Uniform Load	GZ	NO	0	-8.45	1	-8.45	0	0	0	0
1132	Uniform Load	GZ	NO	0	-0.39	1	-0.39	0	0	0	0
1133	Uniform Load	GZ	NO	0	-0.71	1	-0.71	0	0	0	0
1133	Uniform Load	GZ	NO	0	-1	1	-1	0	0	0	0
1133	Uniform Load	GZ	NO	0	-8.45	1	-8.45	0	0	0	0
1133	Uniform Load	GZ	NO	0	-6.6	1	-6.6	0	0	0	0
1133	Uniform Load	GZ	NO	0	-2.25	1	-2.25	0	0	0	0
1133	Uniform Load	GZ	NO	0	-2.6	1	-2.6	0	0	0	0
1134	Uniform Load	GZ	NO	0	-0.39	1	-0.39	0	0	0	0
1134	Uniform Load	GZ	NO	0	-1	1	-1	0	0	0	0
1134	Uniform Load	GZ	NO	0	-2.6	1	-2.6	0	0	0	0
1134	Uniform Load	GZ	NO	0	-0.71	1	-0.71	0	0	0	0
1134	Uniform Load	GZ	NO	0	-8.45	1	-8.45	0	0	0	0
1134	Uniform Load	GZ	NO	0	-0.39	1	-0.39	0	0	0	0
1134	Uniform Load	GZ	NO	0	-2.25	1	-2.25	0	0	0	0
1134	Uniform Load	GZ	NO	0	-6.6	1	-6.6	0	0	0	0
1135	Uniform Load	GZ	NO	0	-2.25	1	-2.25	0	0	0	0
1135	Uniform Load	GZ	NO	0	-0.71	1	-0.71	0	0	0	0
1135	Uniform Load	GZ	NO	0	-1	1	-1	0	0	0	0
1135	Uniform Load	GZ	NO	0	-8.45	1	-8.45	0	0	0	0
1135	Uniform Load	GZ	NO	0	-2.6	1	-2.6	0	0	0	0
1135	Uniform Load	GZ	NO	0	-0.39	1	-0.39	0	0	0	0
1135	Uniform Load	GZ	NO	0	-6.6	1	-6.6	0	0	0	0
1136	Uniform Load	GZ	NO	0	-2.25	1	-2.25	0	0	0	0
1136	Uniform Load	GZ	NO	0	-0.71	1	-0.71	0	0	0	0
1136	Uniform Load	GZ	NO	0	-2.6	1	-2.6	0	0	0	0
1136	Uniform Load	GZ	NO	0	-6.6	1	-6.6	0	0	0	0
1136	Uniform Load	GZ	NO	0	-1	1	-1	0	0	0	0
1136	Uniform Load	GZ	NO	0	-8.45	1	-8.45	0	0	0	0
1136	Uniform Load	GZ	NO	0	-0.39	1	-0.39	0	0	0	0
1137	Uniform Load	GZ	NO	0	-2.6	1	-2.6	0	0	0	0
1137	Uniform Load	GZ	NO	0	-1	1	-1	0	0	0	0
1137	Uniform Load	GZ	NO	0	-0.39	1	-0.39	0	0	0	0
1137	Uniform Load	GZ	NO	0	-8.45	1	-8.45	0	0	0	0
1137	Uniform Load	GZ	NO	0	-6.6	1	-6.6	0	0	0	0
1137	Uniform Load	GZ	NO	0	-2.25	1	-2.25	0	0	0	0
1137	Uniform Load	GZ	NO	0	-0.71	1	-0.71	0	0	0	0
1138	Uniform Load	GZ	NO	0	-8.45	1	-8.45	0	0	0	0
1138	Uniform Load	GZ	NO	0	-0.39	1	-0.39	0	0	0	0
1138	Uniform Load	GZ	NO	0	-2.25	1	-2.25	0	0	0	0
1138	Uniform Load	GZ	NO	0	-6.6	1	-6.6	0	0	0	0
1138	Uniform Load	GZ	NO	0	-1	1	-1	0	0	0	0
1138	Uniform Load	GZ	NO	0	-2.6	1	-2.6	0	0	0	0
1138	Uniform Load	GZ	NO	0	-0.71	1	-0.71	0	0	0	0
1139	Uniform Load	GZ	NO	0	-6.6	1	-6.6	0	0	0	0
1139	Uniform Load	GZ	NO	0	-1	1	-1	0	0	0	0
1139	Uniform Load	GZ	NO	0	-8.45	1	-8.45	0	0	0	0
1139	Uniform Load	GZ	NO	0	-0.71	1	-0.71	0	0	0	0
1139	Uniform Load	GZ	NO	0	-2.25	1	-2.25	0	0	0	0
1139	Uniform Load	GZ	NO	0	-2.6	1	-2.6	0	0	0	0
1139	Uniform Load	GZ	NO	0	-0.39	1	-0.39	0	0	0	0
1140	Uniform Load	GZ	NO	0	-8.45	1	-8.45	0	0	0	0
1140	Uniform Load	GZ	NO	0	-0.39	1	-0.39	0	0	0	0
1140	Uniform Load	GZ	NO	0	-6.6	1	-6.6	0	0	0	0
1140	Uniform Load	GZ	NO	0	-1	1	-1	0	0	0	0
1140	Uniform Load	GZ	NO	0	-2.25	1	-2.25	0	0	0	0
1140	Uniform Load	GZ	NO	0	-2.6	1	-2.6	0	0	0	0
1140	Uniform Load	GZ	NO	0	-0.71	1	-0.71	0	0	0	0
1141	Uniform Load	GZ	NO	0	-2.25	1	-2.25	0	0	0	0
1141	Uniform Load	GZ	NO	0	-0.39	1	-0.39	0	0	0	0
1141	Uniform Load	GZ	NO	0	-6.6	1	-6.6	0	0	0	0
1141	Uniform Load	GZ	NO	0	-2.6	1	-2.6	0	0	0	0
1141	Uniform Load	GZ	NO	0	-0.71	1	-0.71	0	0	0	0
1141	Uniform Load	GZ	NO	0	-8.45	1	-8.45	0	0	0	0

Sovrapasso di ingresso - Ponte strallato - Relazione di calcolo

1141	Uniform Load	GZ	NO	0	-1	1	-1	0	0	0	0
1142	Uniform Load	GZ	NO	0	-1	1	-1	0	0	0	0
1142	Uniform Load	GZ	NO	0	-0.39	1	-0.39	0	0	0	0
1142	Uniform Load	GZ	NO	0	-0.71	1	-0.71	0	0	0	0
1142	Uniform Load	GZ	NO	0	-2.25	1	-2.25	0	0	0	0
1142	Uniform Load	GZ	NO	0	-8.45	1	-8.45	0	0	0	0
1142	Uniform Load	GZ	NO	0	-2.6	1	-2.6	0	0	0	0
1142	Uniform Load	GZ	NO	0	-6.6	1	-6.6	0	0	0	0
1143	Uniform Load	GZ	NO	0	-1	1	-1	0	0	0	0
1143	Uniform Load	GZ	NO	0	-0.71	1	-0.71	0	0	0	0
1143	Uniform Load	GZ	NO	0	-6.6	1	-6.6	0	0	0	0
1143	Uniform Load	GZ	NO	0	-8.45	1	-8.45	0	0	0	0
1143	Uniform Load	GZ	NO	0	-2.25	1	-2.25	0	0	0	0
1143	Uniform Load	GZ	NO	0	-2.6	1	-2.6	0	0	0	0
1143	Uniform Load	GZ	NO	0	-0.39	1	-0.39	0	0	0	0
1144	Uniform Load	GZ	NO	0	-0.71	1	-0.71	0	0	0	0
1144	Uniform Load	GZ	NO	0	-0.39	1	-0.39	0	0	0	0
1144	Uniform Load	GZ	NO	0	-6.6	1	-6.6	0	0	0	0
1144	Uniform Load	GZ	NO	0	-1	1	-1	0	0	0	0
1144	Uniform Load	GZ	NO	0	-2.25	1	-2.25	0	0	0	0
1144	Uniform Load	GZ	NO	0	-2.6	1	-2.6	0	0	0	0
1144	Uniform Load	GZ	NO	0	-8.45	1	-8.45	0	0	0	0
1145	Uniform Load	GZ	NO	0	-2.6	1	-2.6	0	0	0	0
1145	Uniform Load	GZ	NO	0	-1	1	-1	0	0	0	0
1145	Uniform Load	GZ	NO	0	-6.6	1	-6.6	0	0	0	0
1145	Uniform Load	GZ	NO	0	-0.39	1	-0.39	0	0	0	0
1145	Uniform Load	GZ	NO	0	-8.45	1	-8.45	0	0	0	0
1145	Uniform Load	GZ	NO	0	-0.71	1	-0.71	0	0	0	0
1145	Uniform Load	GZ	NO	0	-2.25	1	-2.25	0	0	0	0
1146	Uniform Load	GZ	NO	0	-0.39	1	-0.39	0	0	0	0
1146	Uniform Load	GZ	NO	0	-2.25	1	-2.25	0	0	0	0
1146	Uniform Load	GZ	NO	0	-1	1	-1	0	0	0	0
1146	Uniform Load	GZ	NO	0	-0.71	1	-0.71	0	0	0	0
1146	Uniform Load	GZ	NO	0	-6.6	1	-6.6	0	0	0	0
1146	Uniform Load	GZ	NO	0	-2.6	1	-2.6	0	0	0	0
1146	Uniform Load	GZ	NO	0	-8.45	1	-8.45	0	0	0	0
1147	Uniform Load	GZ	NO	0	-8.45	1	-8.45	0	0	0	0
1147	Uniform Load	GZ	NO	0	-2.6	1	-2.6	0	0	0	0
1147	Uniform Load	GZ	NO	0	-0.71	1	-0.71	0	0	0	0
1147	Uniform Load	GZ	NO	0	-6.6	1	-6.6	0	0	0	0
1147	Uniform Load	GZ	NO	0	-2.25	1	-2.25	0	0	0	0
1147	Uniform Load	GZ	NO	0	-1	1	-1	0	0	0	0
1147	Uniform Load	GZ	NO	0	-0.39	1	-0.39	0	0	0	0
1148	Uniform Load	GZ	NO	0	-2.25	1	-2.25	0	0	0	0
1148	Uniform Load	GZ	NO	0	-8.45	1	-8.45	0	0	0	0
1148	Uniform Load	GZ	NO	0	-0.71	1	-0.71	0	0	0	0
1148	Uniform Load	GZ	NO	0	-6.6	1	-6.6	0	0	0	0
1148	Uniform Load	GZ	NO	0	-2.6	1	-2.6	0	0	0	0
1148	Uniform Load	GZ	NO	0	-0.39	1	-0.39	0	0	0	0
1148	Uniform Load	GZ	NO	0	-1	1	-1	0	0	0	0
1149	Uniform Load	GZ	NO	0	-2.6	1	-2.6	0	0	0	0
1149	Uniform Load	GZ	NO	0	-2.25	1	-2.25	0	0	0	0
1149	Uniform Load	GZ	NO	0	-0.39	1	-0.39	0	0	0	0
1149	Uniform Load	GZ	NO	0	-0.71	1	-0.71	0	0	0	0
1149	Uniform Load	GZ	NO	0	-6.6	1	-6.6	0	0	0	0
1149	Uniform Load	GZ	NO	0	-1	1	-1	0	0	0	0
1149	Uniform Load	GZ	NO	0	-8.45	1	-8.45	0	0	0	0
1150	Uniform Load	GZ	NO	0	-6.6	1	-6.6	0	0	0	0
1150	Uniform Load	GZ	NO	0	-0.71	1	-0.71	0	0	0	0
1150	Uniform Load	GZ	NO	0	-8.45	1	-8.45	0	0	0	0
1150	Uniform Load	GZ	NO	0	-1	1	-1	0	0	0	0
1150	Uniform Load	GZ	NO	0	-2.25	1	-2.25	0	0	0	0
1150	Uniform Load	GZ	NO	0	-2.6	1	-2.6	0	0	0	0
1150	Uniform Load	GZ	NO	0	-0.39	1	-0.39	0	0	0	0
1151	Uniform Load	GZ	NO	0	-0.39	1	-0.39	0	0	0	0
1151	Uniform Load	GZ	NO	0	-0.71	1	-0.71	0	0	0	0
1151	Uniform Load	GZ	NO	0	-1	1	-1	0	0	0	0
1151	Uniform Load	GZ	NO	0	-2.25	1	-2.25	0	0	0	0
1151	Uniform Load	GZ	NO	0	-6.6	1	-6.6	0	0	0	0
1151	Uniform Load	GZ	NO	0	-8.45	1	-8.45	0	0	0	0
1151	Uniform Load	GZ	NO	0	-2.6	1	-2.6	0	0	0	0
1152	Uniform Load	GZ	NO	0	-6.6	1	-6.6	0	0	0	0
1152	Uniform Load	GZ	NO	0	-0.71	1	-0.71	0	0	0	0
1152	Uniform Load	GZ	NO	0	-2.6	1	-2.6	0	0	0	0
1152	Uniform Load	GZ	NO	0	-1	1	-1	0	0	0	0
1152	Uniform Load	GZ	NO	0	-8.45	1	-8.45	0	0	0	0
1152	Uniform Load	GZ	NO	0	-2.25	1	-2.25	0	0	0	0
1152	Uniform Load	GZ	NO	0	-0.39	1	-0.39	0	0	0	0
1153	Uniform Load	GZ	NO	0	-2.25	1	-2.25	0	0	0	0
1153	Uniform Load	GZ	NO	0	-0.39	1	-0.39	0	0	0	0
1153	Uniform Load	GZ	NO	0	-2.6	1	-2.6	0	0	0	0
1153	Uniform Load	GZ	NO	0	-0.71	1	-0.71	0	0	0	0
1153	Uniform Load	GZ	NO	0	-6.6	1	-6.6	0	0	0	0
1153	Uniform Load	GZ	NO	0	-8.45	1	-8.45	0	0	0	0
1153	Uniform Load	GZ	NO	0	-1	1	-1	0	0	0	0
1154	Uniform Load	GZ	NO	0	-0.39	1	-0.39	0	0	0	0
1154	Uniform Load	GZ	NO	0	-8.45	1	-8.45	0	0	0	0
1154	Uniform Load	GZ	NO	0	-1	1	-1	0	0	0	0
1154	Uniform Load	GZ	NO	0	-0.71	1	-0.71	0	0	0	0
1154	Uniform Load	GZ	NO	0	-2.6	1	-2.6	0	0	0	0
1154	Uniform Load	GZ	NO	0	-6.6	1	-6.6	0	0	0	0
1154	Uniform Load	GZ	NO	0	-2.25	1	-2.25	0	0	0	0
1155	Uniform Load	GZ	NO	0	-2.25	1	-2.25	0	0	0	0
1155	Uniform Load	GZ	NO	0	-2.6	1	-2.6	0	0	0	0
1155	Uniform Load	GZ	NO	0	-0.39	1	-0.39	0	0	0	0
1155	Uniform Load	GZ	NO	0	-1	1	-1	0	0	0	0
1155	Uniform Load	GZ	NO	0	-8.45	1	-8.45	0	0	0	0
1155	Uniform Load	GZ	NO	0	-0.71	1	-0.71	0	0	0	0
1155	Uniform Load	GZ	NO	0	-6.6	1	-6.6	0	0	0	0
1156	Uniform Load	GZ	NO	0	-0.39	1	-0.39	0	0	0	0

Sovrapasso di ingresso - Ponte strallato - Relazione di calcolo

1156	Uniform Load	GZ	NO	0	-2.25	1	-2.25	0	0	0	0
1156	Uniform Load	GZ	NO	0	-0.71	1	-0.71	0	0	0	0
1156	Uniform Load	GZ	NO	0	-2.6	1	-2.6	0	0	0	0
1156	Uniform Load	GZ	NO	0	-6.6	1	-6.6	0	0	0	0
1156	Uniform Load	GZ	NO	0	-8.45	1	-8.45	0	0	0	0
1156	Uniform Load	GZ	NO	0	-1	1	-1	0	0	0	0
1157	Uniform Load	GZ	NO	0	-2.6	1	-2.6	0	0	0	0
1157	Uniform Load	GZ	NO	0	-8.45	1	-8.45	0	0	0	0
1157	Uniform Load	GZ	NO	0	-2.25	1	-2.25	0	0	0	0
1157	Uniform Load	GZ	NO	0	-6.6	1	-6.6	0	0	0	0
1157	Uniform Load	GZ	NO	0	-0.71	1	-0.71	0	0	0	0
1157	Uniform Load	GZ	NO	0	-1	1	-1	0	0	0	0
1157	Uniform Load	GZ	NO	0	-0.39	1	-0.39	0	0	0	0
1158	Uniform Load	GZ	NO	0	-0.39	1	-0.39	0	0	0	0
1158	Uniform Load	GZ	NO	0	-8.45	1	-8.45	0	0	0	0
1158	Uniform Load	GZ	NO	0	-2.6	1	-2.6	0	0	0	0
1158	Uniform Load	GZ	NO	0	-2.25	1	-2.25	0	0	0	0
1158	Uniform Load	GZ	NO	0	-6.6	1	-6.6	0	0	0	0
1158	Uniform Load	GZ	NO	0	-0.71	1	-0.71	0	0	0	0
1158	Uniform Load	GZ	NO	0	-1	1	-1	0	0	0	0
1159	Uniform Load	GZ	NO	0	-0.39	1	-0.39	0	0	0	0
1159	Uniform Load	GZ	NO	0	-2.25	1	-2.25	0	0	0	0
1159	Uniform Load	GZ	NO	0	-2.6	1	-2.6	0	0	0	0
1159	Uniform Load	GZ	NO	0	-1	1	-1	0	0	0	0
1159	Uniform Load	GZ	NO	0	-0.71	1	-0.71	0	0	0	0
1159	Uniform Load	GZ	NO	0	-8.45	1	-8.45	0	0	0	0
1159	Uniform Load	GZ	NO	0	-6.6	1	-6.6	0	0	0	0
1160	Uniform Load	GZ	NO	0	-0.39	1	-0.39	0	0	0	0
1160	Uniform Load	GZ	NO	0	-2.6	1	-2.6	0	0	0	0
1160	Uniform Load	GZ	NO	0	-1	1	-1	0	0	0	0
1160	Uniform Load	GZ	NO	0	-2.25	1	-2.25	0	0	0	0
1160	Uniform Load	GZ	NO	0	-6.6	1	-6.6	0	0	0	0
1160	Uniform Load	GZ	NO	0	-8.45	1	-8.45	0	0	0	0
1160	Uniform Load	GZ	NO	0	-0.71	1	-0.71	0	0	0	0
1161	Uniform Load	GZ	NO	0	-6.6	1	-6.6	0	0	0	0
1161	Uniform Load	GZ	NO	0	-8.45	1	-8.45	0	0	0	0
1161	Uniform Load	GZ	NO	0	-0.71	1	-0.71	0	0	0	0
1161	Uniform Load	GZ	NO	0	-1	1	-1	0	0	0	0
1161	Uniform Load	GZ	NO	0	-2.6	1	-2.6	0	0	0	0
1161	Uniform Load	GZ	NO	0	-2.25	1	-2.25	0	0	0	0
1161	Uniform Load	GZ	NO	0	-0.39	1	-0.39	0	0	0	0
1162	Uniform Load	GZ	NO	0	-0.25	1	-0.25	0	0	0	0
1164	Uniform Load	GZ	NO	0	-0.25	1	-0.25	0	0	0	0
1165	Uniform Load	GZ	NO	0	-0.25	1	-0.25	0	0	0	0

[LOAD CASE : q3]

** BEAM LOAD DATA

MEMBER	TYPE	DIR.	PROJ.	D1	P1	D2	P2	D3	P3	D4	P4
1000	Uniform Load	LX	NO	0	6.51	1	6.51	0	0	0	0
1001	Uniform Load	LX	NO	0	6.51	1	6.51	0	0	0	0
1002	Uniform Load	LX	NO	0	6.51	1	6.51	0	0	0	0
1003	Uniform Load	LX	NO	0	6.51	1	6.51	0	0	0	0
1004	Uniform Load	LX	NO	0	6.51	1	6.51	0	0	0	0
1005	Uniform Load	LX	NO	0	6.51	1	6.51	0	0	0	0
1006	Uniform Load	LX	NO	0	6.51	1	6.51	0	0	0	0
1007	Uniform Load	LX	NO	0	6.51	1	6.51	0	0	0	0
1008	Uniform Load	LX	NO	0	6.51	1	6.51	0	0	0	0
1009	Uniform Load	LX	NO	0	6.51	1	6.51	0	0	0	0
1010	Uniform Load	LX	NO	0	6.51	1	6.51	0	0	0	0
1011	Uniform Load	LX	NO	0	6.51	1	6.51	0	0	0	0
1012	Uniform Load	LX	NO	0	6.51	1	6.51	0	0	0	0
1013	Uniform Load	LX	NO	0	6.51	1	6.51	0	0	0	0
1014	Uniform Load	LX	NO	0	6.51	1	6.51	0	0	0	0
1015	Uniform Load	LX	NO	0	6.51	1	6.51	0	0	0	0
1016	Uniform Load	LX	NO	0	6.51	1	6.51	0	0	0	0
1017	Uniform Load	LX	NO	0	6.51	1	6.51	0	0	0	0
1018	Uniform Load	LX	NO	0	6.51	1	6.51	0	0	0	0
1019	Uniform Load	LX	NO	0	6.51	1	6.51	0	0	0	0
1020	Uniform Load	LX	NO	0	6.51	1	6.51	0	0	0	0
1021	Uniform Load	LX	NO	0	6.51	1	6.51	0	0	0	0
1022	Uniform Load	LX	NO	0	6.51	1	6.51	0	0	0	0
1023	Uniform Load	LX	NO	0	6.51	1	6.51	0	0	0	0
1024	Uniform Load	LX	NO	0	6.51	1	6.51	0	0	0	0
1025	Uniform Load	LX	NO	0	6.51	1	6.51	0	0	0	0
1026	Uniform Load	LX	NO	0	6.51	1	6.51	0	0	0	0
1027	Uniform Load	LX	NO	0	6.51	1	6.51	0	0	0	0
1028	Uniform Load	LX	NO	0	6.51	1	6.51	0	0	0	0
1029	Uniform Load	LX	NO	0	6.51	1	6.51	0	0	0	0
1030	Uniform Load	LX	NO	0	6.51	1	6.51	0	0	0	0
1031	Uniform Load	LX	NO	0	6.51	1	6.51	0	0	0	0
1032	Uniform Load	LX	NO	0	6.51	1	6.51	0	0	0	0
1033	Uniform Load	LX	NO	0	6.51	1	6.51	0	0	0	0
1034	Uniform Load	LX	NO	0	6.51	1	6.51	0	0	0	0
1035	Uniform Load	LX	NO	0	6.51	1	6.51	0	0	0	0
1036	Uniform Load	LX	NO	0	6.51	1	6.51	0	0	0	0
1037	Uniform Load	LX	NO	0	6.51	1	6.51	0	0	0	0
1038	Uniform Load	LX	NO	0	6.51	1	6.51	0	0	0	0
1039	Uniform Load	LX	NO	0	6.51	1	6.51	0	0	0	0
1040	Uniform Load	LX	NO	0	6.51	1	6.51	0	0	0	0
1041	Uniform Load	LX	NO	0	6.51	1	6.51	0	0	0	0
1042	Uniform Load	LX	NO	0	6.51	1	6.51	0	0	0	0
1043	Uniform Load	LX	NO	0	6.51	1	6.51	0	0	0	0
1044	Uniform Load	LX	NO	0	6.51	1	6.51	0	0	0	0
1045	Uniform Load	LX	NO	0	6.51	1	6.51	0	0	0	0
1046	Uniform Load	LX	NO	0	6.51	1	6.51	0	0	0	0
1047	Uniform Load	LX	NO	0	6.51	1	6.51	0	0	0	0

Sovrapasso di ingresso - Ponte strallato - Relazione di calcolo

1148	Uniform Load	LX	NO	0	6.51	1	6.51	0	0	0	0
1149	Uniform Load	LX	NO	0	6.51	1	6.51	0	0	0	0
1150	Uniform Load	LX	NO	0	6.51	1	6.51	0	0	0	0
1151	Uniform Load	LX	NO	0	6.51	1	6.51	0	0	0	0
1152	Uniform Load	LX	NO	0	6.51	1	6.51	0	0	0	0
1153	Uniform Load	LX	NO	0	6.51	1	6.51	0	0	0	0
1154	Uniform Load	LX	NO	0	6.51	1	6.51	0	0	0	0
1155	Uniform Load	LX	NO	0	6.51	1	6.51	0	0	0	0
1156	Uniform Load	LX	NO	0	6.51	1	6.51	0	0	0	0
1157	Uniform Load	LX	NO	0	6.51	1	6.51	0	0	0	0
1158	Uniform Load	LX	NO	0	6.51	1	6.51	0	0	0	0
1159	Uniform Load	LX	NO	0	6.51	1	6.51	0	0	0	0
1160	Uniform Load	LX	NO	0	6.51	1	6.51	0	0	0	0
1161	Uniform Load	LX	NO	0	6.51	1	6.51	0	0	0	0

[LOAD CASE : q4-1]

** BEAM LOAD DATA

MEMBER	TYPE	DIR.	PROJ.	D1	P1	D2	P2	D3	P3	D4	P4
1001	Concentrated Force	LY	NO	0	200	0	0	0	0	0	0

[LOAD CASE : q4-2]

** BEAM LOAD DATA

MEMBER	TYPE	DIR.	PROJ.	D1	P1	D2	P2	D3	P3	D4	P4
1081	Concentrated Force	LY	NO	0	200	0	0	0	0	0	0

[LOAD CASE : q4-3]

** BEAM LOAD DATA

MEMBER	TYPE	DIR.	PROJ.	D1	P1	D2	P2	D3	P3	D4	P4
1161	Concentrated Force	LY	NO	0	200	0	0	0	0	0	0

[LOAD CASE : q5x_pc]

** NODAL LOAD DATA

NODE	FX	FY	FZ	MX	MY	MZ
229	5.17	0	0	0	0	0
230	4.1	0	0	0	0	0
231	2.94	0	0	0	0	0
232	1.89	0	0	0	0	0
233	4.6	0	0	0	0	0
234	3.5	0	0	0	0	0
235	2.4	0	0	0	0	0
238	5.17	0	0	0	0	0
239	4.1	0	0	0	0	0
240	2.94	0	0	0	0	0
241	1.89	0	0	0	0	0
242	4.6	0	0	0	0	0
243	3.5	0	0	0	0	0
244	2.4	0	0	0	0	0
501	5.75	0	0	0	0	0
502	5.17	0	0	0	0	0
503	4.6	0	0	0	0	0
504	4.1	0	0	0	0	0
505	3.5	0	0	0	0	0
506	2.94	0	0	0	0	0
507	2.4	0	0	0	0	0
510	5.75	0	0	0	0	0
511	5.17	0	0	0	0	0
512	4.6	0	0	0	0	0
513	4.1	0	0	0	0	0
514	3.5	0	0	0	0	0
515	2.94	0	0	0	0	0
516	2.4	0	0	0	0	0

** BEAM LOAD DATA

MEMBER	TYPE	DIR.	PROJ.	D1	P1	D2	P2	D3	P3	D4	P4
1	Uniform Load	GX	NO	0	6.4	1	6.4	0	0	0	0
2	Uniform Load	GX	NO	0	6.4	1	6.4	0	0	0	0
3	Uniform Load	GX	NO	0	4.32	1	4.32	0	0	0	0
4	Uniform Load	GX	NO	0	4.32	1	4.32	0	0	0	0
75	Uniform Load	GX	NO	0	5.29	1	5.29	0	0	0	0
87	Uniform Load	GX	NO	0	1.1	1	1.1	0	0	0	0
91	Uniform Load	GX	NO	0	5.2	1	5.2	0	0	0	0
103	Uniform Load	GX	NO	0	1	1	1	0	0	0	0
107	Uniform Load	GX	NO	0	5.1	1	5.1	0	0	0	0
120	Uniform Load	GX	NO	0	4.96	1	4.96	0	0	0	0
122	Uniform Load	GX	NO	0	1	1	1	0	0	0	0
124	Uniform Load	GX	NO	0	4.81	1	4.81	0	0	0	0
126	Uniform Load	GX	NO	0	0.96	1	0.96	0	0	0	0
127	Uniform Load	GX	NO	0	4.6	1	4.6	0	0	0	0
129	Uniform Load	GX	NO	0	0.92	1	0.92	0	0	0	0
131	Uniform Load	GX	NO	0	4.54	1	4.54	0	0	0	0
134	Uniform Load	GX	NO	0	4.4	1	4.4	0	0	0	0

Sovrapasso di ingresso - Ponte strallato - Relazione di calcolo

136	Uniform Load	GX	NO	0	0.9	1	0.9	0	0	0	0
138	Uniform Load	GX	NO	0	0.88	1	0.88	0	0	0	0
140	Uniform Load	GX	NO	0	4.32	1	4.32	0	0	0	0
142	Uniform Load	GX	NO	0	0.86	1	0.86	0	0	0	0
420	Uniform Load	GX	NO	0	7.03	1	7.03	0	0	0	0
421	Uniform Load	GX	NO	0	7.03	1	7.03	0	0	0	0
838	Uniform Load	GX	NO	0	5.27	1	5.27	0	0	0	0
840	Uniform Load	GX	NO	0	4.54	1	4.54	0	0	0	0
841	Uniform Load	GX	NO	0	4.54	1	4.54	0	0	0	0
842	Uniform Load	GX	NO	0	4.4	1	4.4	0	0	0	0
843	Uniform Load	GX	NO	0	4.4	1	4.4	0	0	0	0
844	Uniform Load	GX	NO	0	4.6	1	4.6	0	0	0	0
845	Uniform Load	GX	NO	0	4.6	1	4.6	0	0	0	0
846	Uniform Load	GX	NO	0	4.81	1	4.81	0	0	0	0
847	Uniform Load	GX	NO	0	4.96	1	4.96	0	0	0	0
854	Uniform Load	GX	NO	0	1.06	1	1.06	0	0	0	0
856	Uniform Load	GX	NO	0	0.9	1	0.9	0	0	0	0
857	Uniform Load	GX	NO	0	0.9	1	0.9	0	0	0	0
858	Uniform Load	GX	NO	0	0.88	1	0.88	0	0	0	0
859	Uniform Load	GX	NO	0	0.88	1	0.88	0	0	0	0
860	Uniform Load	GX	NO	0	0.92	1	0.92	0	0	0	0
861	Uniform Load	GX	NO	0	0.92	1	0.92	0	0	0	0
862	Uniform Load	GX	NO	0	0.96	1	0.96	0	0	0	0
863	Uniform Load	GX	NO	0	1	1	1	0	0	0	0
980	Uniform Load	GX	NO	0	6.4	1	6.4	0	0	0	0
981	Uniform Load	GX	NO	0	6.4	1	6.4	0	0	0	0
982	Uniform Load	GX	NO	0	6.4	1	6.4	0	0	0	0
983	Uniform Load	GX	NO	0	6.4	1	6.4	0	0	0	0
984	Uniform Load	GX	NO	0	6.4	1	6.4	0	0	0	0
985	Uniform Load	GX	NO	0	6.4	1	6.4	0	0	0	0
986	Uniform Load	GX	NO	0	6.4	1	6.4	0	0	0	0
987	Uniform Load	GX	NO	0	6.4	1	6.4	0	0	0	0
988	Uniform Load	GX	NO	0	6.4	1	6.4	0	0	0	0
991	Uniform Load	GX	NO	0	6.4	1	6.4	0	0	0	0
992	Uniform Load	GX	NO	0	6.4	1	6.4	0	0	0	0
993	Uniform Load	GX	NO	0	6.4	1	6.4	0	0	0	0
994	Uniform Load	GX	NO	0	6.4	1	6.4	0	0	0	0
995	Uniform Load	GX	NO	0	6.4	1	6.4	0	0	0	0
996	Uniform Load	GX	NO	0	6.4	1	6.4	0	0	0	0
997	Uniform Load	GX	NO	0	6.4	1	6.4	0	0	0	0
998	Uniform Load	GX	NO	0	6.4	1	6.4	0	0	0	0
999	Uniform Load	GX	NO	0	6.4	1	6.4	0	0	0	0
1163	Uniform Load	GX	NO	0	1.1	1	1.1	0	0	0	0
1169	Uniform Load	GX	NO	0	5.34	1	5.34	0	0	0	0
1171	Uniform Load	GX	NO	0	1.1	1	1.1	0	0	0	0
1222	Uniform Load	GX	NO	0	7.03	1	7.03	0	0	0	0
1223	Uniform Load	GX	NO	0	7.03	1	7.03	0	0	0	0

[LOAD CASE : q5y_pc]

** NODAL LOAD DATA

NODE	FX	FY	FZ	MX	MY	MZ
229	0	5.17	0	0	0	0
230	0	4.1	0	0	0	0
231	0	2.94	0	0	0	0
232	0	1.89	0	0	0	0
233	0	4.6	0	0	0	0
234	0	3.5	0	0	0	0
235	0	2.4	0	0	0	0
238	0	5.17	0	0	0	0
239	0	4.1	0	0	0	0
240	0	2.94	0	0	0	0
241	0	1.89	0	0	0	0
242	0	4.6	0	0	0	0
243	0	3.5	0	0	0	0
244	0	2.4	0	0	0	0
501	0	5.75	0	0	0	0
502	0	5.17	0	0	0	0
503	0	4.6	0	0	0	0
504	0	4.1	0	0	0	0
505	0	3.5	0	0	0	0
506	0	2.94	0	0	0	0
507	0	2.4	0	0	0	0
510	0	5.75	0	0	0	0
511	0	5.17	0	0	0	0
512	0	4.6	0	0	0	0
513	0	4.1	0	0	0	0
514	0	3.5	0	0	0	0
515	0	2.94	0	0	0	0
516	0	2.4	0	0	0	0

** BEAM LOAD DATA

MEMBER	TYPE	DIR.	PROJ.	D1	P1	D2	P2	D3	P3	D4	P4
1	Uniform Load	GY	NO	0	6.4	1	6.4	0	0	0	0
2	Uniform Load	GY	NO	0	6.4	1	6.4	0	0	0	0
3	Uniform Load	GY	NO	0	2.64	1	2.64	0	0	0	0
4	Uniform Load	GY	NO	0	2.64	1	2.64	0	0	0	0
75	Uniform Load	GY	NO	0	1.72	1	1.72	0	0	0	0
80	Uniform Load	GY	NO	0	0.312	1	0.312	0	0	0	0
82	Uniform Load	GY	NO	0	0.312	1	0.312	0	0	0	0
87	Uniform Load	GY	NO	0	1.64	1	1.64	0	0	0	0
91	Uniform Load	GY	NO	0	1.64	1	1.64	0	0	0	0
96	Uniform Load	GY	NO	0	0.324	1	0.324	0	0	0	0
98	Uniform Load	GY	NO	0	0.324	1	0.324	0	0	0	0

Sovrapasso di ingresso - Ponte strallato - Relazione di calcolo

103	Uniform Load	GY	NO	0	1.55	1	1.55	0	0	0	0
107	Uniform Load	GY	NO	0	1.55	1	1.55	0	0	0	0
112	Uniform Load	GY	NO	0	0.424	1	0.424	0	0	0	0
114	Uniform Load	GY	NO	0	0.424	1	0.424	0	0	0	0
116	Uniform Load	GY	NO	0	0.378	1	0.378	0	0	0	0
118	Uniform Load	GY	NO	0	0.378	1	0.378	0	0	0	0
119	Uniform Load	GY	NO	0	0.368	1	0.368	0	0	0	0
120	Uniform Load	GY	NO	0	1.44	1	1.44	0	0	0	0
121	Uniform Load	GY	NO	0	0.368	1	0.368	0	0	0	0
122	Uniform Load	GY	NO	0	1.44	1	1.44	0	0	0	0
123	Uniform Load	GY	NO	0	0.36	1	0.36	0	0	0	0
124	Uniform Load	GY	NO	0	1.33	1	1.33	0	0	0	0
125	Uniform Load	GY	NO	0	0.36	1	0.36	0	0	0	0
126	Uniform Load	GY	NO	0	1.33	1	1.33	0	0	0	0
127	Uniform Load	GY	NO	0	1.2	1	1.2	0	0	0	0
128	Uniform Load	GY	NO	0	0.348	1	0.348	0	0	0	0
129	Uniform Load	GY	NO	0	1.2	1	1.2	0	0	0	0
130	Uniform Load	GY	NO	0	0.348	1	0.348	0	0	0	0
131	Uniform Load	GY	NO	0	0.996	1	0.996	0	0	0	0
132	Uniform Load	GY	NO	0	0.336	1	0.336	0	0	0	0
133	Uniform Load	GY	NO	0	0.336	1	0.336	0	0	0	0
134	Uniform Load	GY	NO	0	1.06	1	1.06	0	0	0	0
136	Uniform Load	GY	NO	0	0.996	1	0.996	0	0	0	0
138	Uniform Load	GY	NO	0	1.06	1	1.06	0	0	0	0
140	Uniform Load	GY	NO	0	0.893	1	0.893	0	0	0	0
142	Uniform Load	GY	NO	0	0.893	1	0.893	0	0	0	0
420	Uniform Load	GY	NO	0	2.64	1	2.64	0	0	0	0
421	Uniform Load	GY	NO	0	2.64	1	2.64	0	0	0	0
838	Uniform Load	GY	NO	0	1.79	1	1.79	0	0	0	0
840	Uniform Load	GY	NO	0	0.996	1	0.996	0	0	0	0
841	Uniform Load	GY	NO	0	0.996	1	0.996	0	0	0	0
842	Uniform Load	GY	NO	0	1.06	1	1.06	0	0	0	0
843	Uniform Load	GY	NO	0	1.06	1	1.06	0	0	0	0
844	Uniform Load	GY	NO	0	1.2	1	1.2	0	0	0	0
845	Uniform Load	GY	NO	0	1.2	1	1.2	0	0	0	0
846	Uniform Load	GY	NO	0	1.33	1	1.33	0	0	0	0
847	Uniform Load	GY	NO	0	1.44	1	1.44	0	0	0	0
854	Uniform Load	GY	NO	0	1.79	1	1.79	0	0	0	0
856	Uniform Load	GY	NO	0	0.996	1	0.996	0	0	0	0
857	Uniform Load	GY	NO	0	0.996	1	0.996	0	0	0	0
858	Uniform Load	GY	NO	0	1.06	1	1.06	0	0	0	0
859	Uniform Load	GY	NO	0	1.06	1	1.06	0	0	0	0
860	Uniform Load	GY	NO	0	1.2	1	1.2	0	0	0	0
861	Uniform Load	GY	NO	0	1.2	1	1.2	0	0	0	0
862	Uniform Load	GY	NO	0	1.33	1	1.33	0	0	0	0
863	Uniform Load	GY	NO	0	1.44	1	1.44	0	0	0	0
980	Uniform Load	GY	NO	0	6.4	1	6.4	0	0	0	0
981	Uniform Load	GY	NO	0	6.4	1	6.4	0	0	0	0
982	Uniform Load	GY	NO	0	6.4	1	6.4	0	0	0	0
983	Uniform Load	GY	NO	0	6.4	1	6.4	0	0	0	0
984	Uniform Load	GY	NO	0	6.4	1	6.4	0	0	0	0
985	Uniform Load	GY	NO	0	6.4	1	6.4	0	0	0	0
986	Uniform Load	GY	NO	0	6.4	1	6.4	0	0	0	0
987	Uniform Load	GY	NO	0	6.4	1	6.4	0	0	0	0
988	Uniform Load	GY	NO	0	6.4	1	6.4	0	0	0	0
991	Uniform Load	GY	NO	0	6.4	1	6.4	0	0	0	0
992	Uniform Load	GY	NO	0	6.4	1	6.4	0	0	0	0
993	Uniform Load	GY	NO	0	6.4	1	6.4	0	0	0	0
994	Uniform Load	GY	NO	0	6.4	1	6.4	0	0	0	0
995	Uniform Load	GY	NO	0	6.4	1	6.4	0	0	0	0
996	Uniform Load	GY	NO	0	6.4	1	6.4	0	0	0	0
997	Uniform Load	GY	NO	0	6.4	1	6.4	0	0	0	0
998	Uniform Load	GY	NO	0	6.4	1	6.4	0	0	0	0
999	Uniform Load	GY	NO	0	6.4	1	6.4	0	0	0	0
1163	Uniform Load	GY	NO	0	1.72	1	1.72	0	0	0	0
1166	Uniform Load	GY	NO	0	0.3	1	0.3	0	0	0	0
1167	Uniform Load	GY	NO	0	0.3	1	0.3	0	0	0	0
1169	Uniform Load	GY	NO	0	1.78	1	1.78	0	0	0	0
1171	Uniform Load	GY	NO	0	1.78	1	1.78	0	0	0	0
1174	Uniform Load	GY	NO	0	0.24	1	0.24	0	0	0	0
1177	Uniform Load	GY	NO	0	0.25	1	0.25	0	0	0	0
1178	Uniform Load	GY	NO	0	0.259	1	0.259	0	0	0	0
1181	Uniform Load	GY	NO	0	0.269	1	0.269	0	0	0	0
1182	Uniform Load	GY	NO	0	0.278	1	0.278	0	0	0	0
1185	Uniform Load	GY	NO	0	0.288	1	0.288	0	0	0	0
1186	Uniform Load	GY	NO	0	0.294	1	0.294	0	0	0	0
1189	Uniform Load	GY	NO	0	0.302	1	0.302	0	0	0	0
1190	Uniform Load	GY	NO	0	0.339	1	0.339	0	0	0	0
1193	Uniform Load	GY	NO	0	0.24	1	0.24	0	0	0	0
1194	Uniform Load	GY	NO	0	0.25	1	0.25	0	0	0	0
1197	Uniform Load	GY	NO	0	0.259	1	0.259	0	0	0	0
1198	Uniform Load	GY	NO	0	0.269	1	0.269	0	0	0	0
1201	Uniform Load	GY	NO	0	0.278	1	0.278	0	0	0	0
1202	Uniform Load	GY	NO	0	0.288	1	0.288	0	0	0	0
1205	Uniform Load	GY	NO	0	0.294	1	0.294	0	0	0	0
1206	Uniform Load	GY	NO	0	0.302	1	0.302	0	0	0	0
1209	Uniform Load	GY	NO	0	0.339	1	0.339	0	0	0	0
1210	Uniform Load	GY	NO	0	0.282	1	0.282	0	0	0	0
1211	Uniform Load	GY	NO	0	0.282	1	0.282	0	0	0	0
1219	Uniform Load	GY	NO	0	0.226	1	0.226	0	0	0	0
1221	Uniform Load	GY	NO	0	0.226	1	0.226	0	0	0	0
1222	Uniform Load	GY	NO	0	2.64	1	2.64	0	0	0	0
1223	Uniform Load	GY	NO	0	2.64	1	2.64	0	0	0	0
1224	Uniform Load	GY	NO	0	3.4	1	3.4	0	0	0	0
1225	Uniform Load	GY	NO	0	3.4	1	3.4	0	0	0	0
1226	Uniform Load	GY	NO	0	3.4	1	3.4	0	0	0	0
1227	Uniform Load	GY	NO	0	3.4	1	3.4	0	0	0	0
1228	Uniform Load	GY	NO	0	3.4	1	3.4	0	0	0	0
1229	Uniform Load	GY	NO	0	3.4	1	3.4	0	0	0	0
1230	Uniform Load	GY	NO	0	3.4	1	3.4	0	0	0	0

Sovrapasso di ingresso - Ponte strallato - Relazione di calcolo

1231	Uniform Load	GY	NO	0	3.4	1	3.4	0	0	0	0
1232	Uniform Load	GY	NO	0	3.4	1	3.4	0	0	0	0

[LOAD CASE : q5x_ps]

** BEAM LOAD DATA

MEMBER	TYPE	DIR.	PROJ.	D1	P1	D2	P2	D3	P3	D4	P4
1	Uniform Load	GX	NO	0	5.16	1	5.16	0	0	0	0
2	Uniform Load	GX	NO	0	5.16	1	5.16	0	0	0	0
980	Uniform Load	GX	NO	0	5.16	1	5.16	0	0	0	0
981	Uniform Load	GX	NO	0	5.16	1	5.16	0	0	0	0
982	Uniform Load	GX	NO	0	5.16	1	5.16	0	0	0	0
983	Uniform Load	GX	NO	0	5.16	1	5.16	0	0	0	0
984	Uniform Load	GX	NO	0	5.16	1	5.16	0	0	0	0
985	Uniform Load	GX	NO	0	5.16	1	5.16	0	0	0	0
986	Uniform Load	GX	NO	0	5.16	1	5.16	0	0	0	0
987	Uniform Load	GX	NO	0	5.16	1	5.16	0	0	0	0
988	Uniform Load	GX	NO	0	5.16	1	5.16	0	0	0	0
991	Uniform Load	GX	NO	0	5.16	1	5.16	0	0	0	0
992	Uniform Load	GX	NO	0	5.16	1	5.16	0	0	0	0
993	Uniform Load	GX	NO	0	5.16	1	5.16	0	0	0	0
994	Uniform Load	GX	NO	0	5.16	1	5.16	0	0	0	0
995	Uniform Load	GX	NO	0	5.16	1	5.16	0	0	0	0
996	Uniform Load	GX	NO	0	5.16	1	5.16	0	0	0	0
997	Uniform Load	GX	NO	0	5.16	1	5.16	0	0	0	0
998	Uniform Load	GX	NO	0	5.16	1	5.16	0	0	0	0
999	Uniform Load	GX	NO	0	5.16	1	5.16	0	0	0	0

[LOAD CASE : q5y_ps]

** BEAM LOAD DATA

MEMBER	TYPE	DIR.	PROJ.	D1	P1	D2	P2	D3	P3	D4	P4
1	Uniform Load	GY	NO	0	5.16	1	5.16	0	0	0	0
2	Uniform Load	GY	NO	0	5.16	1	5.16	0	0	0	0
980	Uniform Load	GY	NO	0	5.16	1	5.16	0	0	0	0
981	Uniform Load	GY	NO	0	5.16	1	5.16	0	0	0	0
982	Uniform Load	GY	NO	0	5.16	1	5.16	0	0	0	0
983	Uniform Load	GY	NO	0	5.16	1	5.16	0	0	0	0
984	Uniform Load	GY	NO	0	5.16	1	5.16	0	0	0	0
985	Uniform Load	GY	NO	0	5.16	1	5.16	0	0	0	0
986	Uniform Load	GY	NO	0	5.16	1	5.16	0	0	0	0
987	Uniform Load	GY	NO	0	5.16	1	5.16	0	0	0	0
988	Uniform Load	GY	NO	0	5.16	1	5.16	0	0	0	0
991	Uniform Load	GY	NO	0	5.16	1	5.16	0	0	0	0
992	Uniform Load	GY	NO	0	5.16	1	5.16	0	0	0	0
993	Uniform Load	GY	NO	0	5.16	1	5.16	0	0	0	0
994	Uniform Load	GY	NO	0	5.16	1	5.16	0	0	0	0
995	Uniform Load	GY	NO	0	5.16	1	5.16	0	0	0	0
996	Uniform Load	GY	NO	0	5.16	1	5.16	0	0	0	0
997	Uniform Load	GY	NO	0	5.16	1	5.16	0	0	0	0
998	Uniform Load	GY	NO	0	5.16	1	5.16	0	0	0	0
999	Uniform Load	GY	NO	0	5.16	1	5.16	0	0	0	0

[LOAD CASE : q7]

** BEAM LOAD DATA

MEMBER	TYPE	DIR.	PROJ.	D1	P1	D2	P2	D3	P3	D4	P4
410	Concentrated Force	LZ	NO	0	26	0	0	0	0	0	0
411	Concentrated Force	LZ	NO	0	17	0	0	0	0	0	0
414	Concentrated Force	LZ	NO	0	17	0	0	0	0	0	0
415	Concentrated Force	LZ	NO	0	26	0	0	0	0	0	0

[LOAD CASE : T]

** MEMBER TEMPERATURE LOAD DATA

MEMBER	TEMPERATURE
15	15
14	15
12	15
11	15
10	15
9	15
8	15
7	15
6	15
20	15
19	15
18	15
17	15
16	15
75	15
91	15
87	15
82	25
80	25
107	15
103	15
98	25

96	25
120	15
122	15
124	15
126	15
127	15
125	25
123	25
121	25
119	25
118	25
116	25
114	25
112	25
129	15
131	15
134	15
136	15
138	15
140	15
142	15
133	25
132	25
130	25
128	25
658	25
659	25
674	25
675	25
676	25
677	25
678	25
679	25
680	25
681	25
682	25
683	25
684	25
685	25
686	25
687	25
688	25
689	25
690	25
691	25
838	15
840	15
841	15
842	15
843	15
844	15
845	15
846	15
847	15
854	15
856	15
857	15
858	15
859	15
860	15
861	15
862	15
863	15
1000	25
1001	25
1002	25
1003	25
1004	25
1005	25
1006	25
1007	25
1008	25
1009	25
1010	25
1011	25
1012	25
1013	25
1014	25
1015	25
1016	25
1017	25
1018	25
1019	25
1020	25
1021	25
1022	25
1023	25
1024	25
1025	25
1026	25
1027	25
1028	25
1029	25
1030	25
1031	25
1032	25
1033	25
1034	25
1035	25
1036	25

1037	25
1038	25
1039	25
1040	25
1041	25
1042	25
1043	25
1044	25
1045	25
1046	25
1047	25
1048	25
1049	25
1050	25
1051	25
1052	25
1053	25
1054	25
1055	25
1056	25
1057	25
1058	25
1059	25
1060	25
1061	25
1062	25
1063	25
1064	25
1065	25
1066	25
1067	25
1068	25
1069	25
1070	25
1071	25
1072	25
1073	25
1074	25
1075	25
1076	25
1077	25
1078	25
1079	25
1080	25
1081	25
1082	25
1083	25
1084	25
1085	25
1086	25
1087	25
1088	25
1089	25
1090	25
1091	25
1092	25
1093	25
1094	25
1095	25
1096	25
1097	25
1098	25
1099	25
1100	25
1101	25
1102	25
1103	25
1104	25
1105	25
1106	25
1107	25
1108	25
1109	25
1110	25
1111	25
1112	25
1113	25
1114	25
1115	25
1116	25
1117	25
1118	25
1119	25
1120	25
1121	25
1122	25
1123	25
1124	25
1125	25
1126	25
1127	25
1128	25
1129	25
1130	25
1131	25
1132	25
1133	25
1134	25
1135	25
1136	25

1137 25
1138 25
1139 25
1140 25
1141 25
1142 25
1143 25
1144 25
1145 25
1146 25
1147 25
1148 25
1149 25
1150 25
1151 25
1163 15
1166 25
1167 25
1152 25
1153 25
1154 25
1155 25
1156 25
1157 25
1158 25
1159 25
1160 25
1161 25
1169 15
1171 15
1174 25
1177 25
1178 25
1181 25
1182 25
1185 25
1186 25
1189 25
1190 25
1194 25
1198 25
1197 25
1193 25
1202 25
1206 25
1209 25
1210 25
1211 25
1205 25
1201 25
1219 25
1221 25
1663 25
1662 25
1661 25
1664 25
1710 25
1718 25
1714 25

[LOAD CASE : DT]

[LOAD CASE : P]

[LOAD CASE : N]

** BEAM LOAD DATA

MEMBER	TYPE	DIR.	PROJ.	D1	P1	D2	P2	D3	P3	D4	P4
1000	Uniform Load	GZ	NO	0	-14.3	1	-14.3	0	0	0	0
1001	Uniform Load	GZ	NO	0	-14.3	1	-14.3	0	0	0	0
1002	Uniform Load	GZ	NO	0	-14.3	1	-14.3	0	0	0	0
1003	Uniform Load	GZ	NO	0	-14.3	1	-14.3	0	0	0	0
1004	Uniform Load	GZ	NO	0	-14.3	1	-14.3	0	0	0	0
1005	Uniform Load	GZ	NO	0	-14.3	1	-14.3	0	0	0	0
1006	Uniform Load	GZ	NO	0	-14.3	1	-14.3	0	0	0	0
1007	Uniform Load	GZ	NO	0	-14.3	1	-14.3	0	0	0	0
1008	Uniform Load	GZ	NO	0	-14.3	1	-14.3	0	0	0	0
1009	Uniform Load	GZ	NO	0	-14.3	1	-14.3	0	0	0	0
1010	Uniform Load	GZ	NO	0	-14.3	1	-14.3	0	0	0	0
1011	Uniform Load	GZ	NO	0	-14.3	1	-14.3	0	0	0	0
1012	Uniform Load	GZ	NO	0	-14.3	1	-14.3	0	0	0	0
1013	Uniform Load	GZ	NO	0	-14.3	1	-14.3	0	0	0	0
1014	Uniform Load	GZ	NO	0	-14.3	1	-14.3	0	0	0	0
1015	Uniform Load	GZ	NO	0	-14.3	1	-14.3	0	0	0	0
1016	Uniform Load	GZ	NO	0	-14.3	1	-14.3	0	0	0	0
1017	Uniform Load	GZ	NO	0	-14.3	1	-14.3	0	0	0	0
1018	Uniform Load	GZ	NO	0	-14.3	1	-14.3	0	0	0	0
1019	Uniform Load	GZ	NO	0	-14.3	1	-14.3	0	0	0	0
1020	Uniform Load	GZ	NO	0	-14.3	1	-14.3	0	0	0	0
1021	Uniform Load	GZ	NO	0	-14.3	1	-14.3	0	0	0	0
1022	Uniform Load	GZ	NO	0	-14.3	1	-14.3	0	0	0	0
1023	Uniform Load	GZ	NO	0	-14.3	1	-14.3	0	0	0	0
1024	Uniform Load	GZ	NO	0	-14.3	1	-14.3	0	0	0	0
1025	Uniform Load	GZ	NO	0	-14.3	1	-14.3	0	0	0	0
1026	Uniform Load	GZ	NO	0	-14.3	1	-14.3	0	0	0	0
1027	Uniform Load	GZ	NO	0	-14.3	1	-14.3	0	0	0	0
1028	Uniform Load	GZ	NO	0	-14.3	1	-14.3	0	0	0	0

Sovrapasso di ingresso - Ponte strallato - Relazione di calcolo

1129	Uniform Load	GZ	NO	0	-14.3	1	-14.3	0	0	0	0
1130	Uniform Load	GZ	NO	0	-14.3	1	-14.3	0	0	0	0
1131	Uniform Load	GZ	NO	0	-14.3	1	-14.3	0	0	0	0
1132	Uniform Load	GZ	NO	0	-14.3	1	-14.3	0	0	0	0
1133	Uniform Load	GZ	NO	0	-14.3	1	-14.3	0	0	0	0
1134	Uniform Load	GZ	NO	0	-14.3	1	-14.3	0	0	0	0
1135	Uniform Load	GZ	NO	0	-14.3	1	-14.3	0	0	0	0
1136	Uniform Load	GZ	NO	0	-14.3	1	-14.3	0	0	0	0
1137	Uniform Load	GZ	NO	0	-14.3	1	-14.3	0	0	0	0
1138	Uniform Load	GZ	NO	0	-14.3	1	-14.3	0	0	0	0
1139	Uniform Load	GZ	NO	0	-14.3	1	-14.3	0	0	0	0
1140	Uniform Load	GZ	NO	0	-14.3	1	-14.3	0	0	0	0
1141	Uniform Load	GZ	NO	0	-14.3	1	-14.3	0	0	0	0
1142	Uniform Load	GZ	NO	0	-14.3	1	-14.3	0	0	0	0
1143	Uniform Load	GZ	NO	0	-14.3	1	-14.3	0	0	0	0
1144	Uniform Load	GZ	NO	0	-14.3	1	-14.3	0	0	0	0
1145	Uniform Load	GZ	NO	0	-14.3	1	-14.3	0	0	0	0
1146	Uniform Load	GZ	NO	0	-14.3	1	-14.3	0	0	0	0
1147	Uniform Load	GZ	NO	0	-14.3	1	-14.3	0	0	0	0
1148	Uniform Load	GZ	NO	0	-14.3	1	-14.3	0	0	0	0
1149	Uniform Load	GZ	NO	0	-14.3	1	-14.3	0	0	0	0
1150	Uniform Load	GZ	NO	0	-14.3	1	-14.3	0	0	0	0
1151	Uniform Load	GZ	NO	0	-14.3	1	-14.3	0	0	0	0
1152	Uniform Load	GZ	NO	0	-14.3	1	-14.3	0	0	0	0
1153	Uniform Load	GZ	NO	0	-14.3	1	-14.3	0	0	0	0
1154	Uniform Load	GZ	NO	0	-14.3	1	-14.3	0	0	0	0
1155	Uniform Load	GZ	NO	0	-14.3	1	-14.3	0	0	0	0
1156	Uniform Load	GZ	NO	0	-14.3	1	-14.3	0	0	0	0
1157	Uniform Load	GZ	NO	0	-14.3	1	-14.3	0	0	0	0
1158	Uniform Load	GZ	NO	0	-14.3	1	-14.3	0	0	0	0
1159	Uniform Load	GZ	NO	0	-14.3	1	-14.3	0	0	0	0
1160	Uniform Load	GZ	NO	0	-14.3	1	-14.3	0	0	0	0
1161	Uniform Load	GZ	NO	0	-14.3	1	-14.3	0	0	0	0

[LOAD CASE : G2t]

*** RESPONSE SPECTRUM FUNCTION DATA

NAME	FUNCTION TYPE	SCALE	GRAVITY	DATA
SLV-xy (q~ Normalized Acc.		1	9.806	0:0.24 0.132:0.607 0.396:0.607 0.491:0.489 0.587:0.409
SLV-z (q=~ Normalized Acc.		1	9.806	0:0.121 0.05:0.306 0.15:0.306 0.235:0.196 0.32:0.144
SLD-xy Normalized Acc.		1	9.806	0:0.115 0.121:0.279 0.363:0.279 0.441:0.231 0.518:0.196
SLD-z Normalized Acc.		1	9.806	0:0.04 0.05:0.097 0.15:0.097 0.235:0.062 0.32:0.046

*** RESPONSE SPECTRUM LOAD CASE DATA

NAME	FUNCTION NAME	DIR.	ANGLE	SCALE	PERIOD FACTOR	ACCIDENTAL ECCENTRICITY

*** LOAD COMBINATION DATA

** GENERAL

NO	NAME	TYPE	ACTIVE	DESCRIPTION
1	G1	Add	ACTIVE	
2	G2	Add	ACTIVE	
3	G1+G2	Add	ACTIVE	
4	G1+G2+P	Add	ACTIVE	
5	G1+G2+P+R~	Add	ACTIVE	
6	(G1+G2+P+~	Add	ACTIVE	
7	Q1k	Envelope	ACTIVE	
8	Q2F	Envelope	ACTIVE	
9	q4	Envelope	ACTIVE	
10	Q2a	Add	ACTIVE	
11	Q2b	Add	ACTIVE	
12	SLU-1	Add	ACTIVE	Q1k; +Vx; +T
13	SLU-2	Add	ACTIVE	Q1k; +Vx; -T
14	SLU-3	Add	ACTIVE	Q1k; -Vx; -T
15	SLU-4	Add	ACTIVE	Q1k; -Vx; +T
16	SLU-5	Add	ACTIVE	Q1k; +Vy; +T
17	SLU-6	Add	ACTIVE	Q1k; +Vy; -T
18	SLU-7	Add	ACTIVE	Q1k; -Vy; -T
19	SLU-8	Add	ACTIVE	Q1k; -Vy; +T
20	SLU-9	Add	ACTIVE	Q2a;Vx
21	SLU-10	Add	ACTIVE	Q2a;Vx
22	SLU-11	Add	ACTIVE	Q2a;Vx
23	SLU-12	Add	ACTIVE	Q2a;Vx
24	SLU-13	Add	ACTIVE	Q2a;Vy
25	SLU-14	Add	ACTIVE	Q2a;Vy
26	SLU-15	Add	ACTIVE	Q2a;Vy
27	SLU-16	Add	ACTIVE	Q2a;Vy
28	SLU-17	Add	ACTIVE	Q2b;Vx
29	SLU-18	Add	ACTIVE	Q2b;Vx
30	SLU-19	Add	ACTIVE	Q2b;Vx
31	SLU-20	Add	ACTIVE	Q2b;Vx
32	SLU-21	Add	ACTIVE	Q2b;Vy
33	SLU-22	Add	ACTIVE	Q2b;Vy
34	SLU-23	Add	ACTIVE	Q2b;Vy
35	SLU-24	Add	ACTIVE	Q2b;Vy
36	SLU-25	Add	ACTIVE	Vx
37	SLU-26	Add	ACTIVE	Vx
38	SLU-27	Add	ACTIVE	Vx
39	SLU-28	Add	ACTIVE	Vx
40	SLU-29	Add	ACTIVE	Vy

41	SLU-30	Add	ACTIVE	Vy
42	SLU-31	Add	ACTIVE	Vy
43	SLU-32	Add	ACTIVE	Vy
44	SLU-33	Add	ACTIVE	T; Vx
45	SLU-34	Add	ACTIVE	T; Vx
46	SLU-35	Add	ACTIVE	T; Vx
47	SLU-36	Add	ACTIVE	T; Vx
48	SLU-37	Add	ACTIVE	T; Vy
49	SLU-38	Add	ACTIVE	T; Vy
50	SLU-39	Add	ACTIVE	T; Vy
51	SLU-40	Add	ACTIVE	T; Vy
52	SLU-41	Add	ACTIVE	DT; Vx
53	SLU-42	Add	ACTIVE	DT; Vx
54	SLU-43	Add	ACTIVE	DT; Vx
55	SLU-44	Add	ACTIVE	DT; Vx
56	SLU-45	Add	ACTIVE	DT; Vy
57	SLU-46	Add	ACTIVE	DT; Vy
58	SLU-47	Add	ACTIVE	DT; Vy
59	SLU-48	Add	ACTIVE	DT; Vy
60	SLU-49	Add	ACTIVE	DT; Vy per appoggi
61	SLU-50	Add	ACTIVE	DT; Vy per appoggi
62	SLU-51	Add	ACTIVE	DT; Vy per appoggi
63	SLU-52	Add	ACTIVE	DT; Vy per appoggi
64	SLU-53	Add	ACTIVE	Q1 per appoggi
65	SLU-54	Add	ACTIVE	Q2a per appoggi
66	SLU-55	Add	ACTIVE	Q2b per appoggi
67	SLU-56	Add	ACTIVE	Vy per appoggi
68	SLU-57	Add	ACTIVE	Vy per appoggi
69	SLU-58	Add	ACTIVE	Vy per appoggi
70	SLU-59	Add	ACTIVE	Vy per appoggi
71	SLU-60	Add	ACTIVE	T; Vy per appoggi
72	SLU-61	Add	ACTIVE	T; Vy per appoggi
73	SLU-62	Add	ACTIVE	T; Vy per appoggi
74	SLU-63	Add	ACTIVE	T; Vy per appoggi
75	SLV1x	Add	ACTIVE	
76	SLV2x	Add	ACTIVE	
77	SLV3x	Add	ACTIVE	
78	SLV4x	Add	ACTIVE	
79	SLV5x	Add	ACTIVE	
80	SLV6x	Add	ACTIVE	
81	SLV7x	Add	ACTIVE	
82	SLV8x	Add	ACTIVE	
83	SLV1y	Add	ACTIVE	
84	SLV2y	Add	ACTIVE	
85	SLV3y	Add	ACTIVE	
86	SLV4y	Add	ACTIVE	
87	SLV5y	Add	ACTIVE	
88	SLV6y	Add	ACTIVE	
89	SLV7y	Add	ACTIVE	
90	SLV8y	Add	ACTIVE	
91	SLV1z	Add	ACTIVE	
92	SLV2z	Add	ACTIVE	
93	SLV3z	Add	ACTIVE	
94	SLV4z	Add	ACTIVE	
95	SLV5z	Add	ACTIVE	
96	SLV6z	Add	ACTIVE	
97	SLV7z	Add	ACTIVE	
98	SLV8z	Add	ACTIVE	
99	SLR-1	Add	ACTIVE	Q1k; Vx
100	SLR-2	Add	ACTIVE	Q1k; Vx
101	SLR-3	Add	ACTIVE	Q1k; Vx
102	SLR-4	Add	ACTIVE	Q1k; Vx
103	SLR-5	Add	ACTIVE	Q1k; Vy
104	SLR-6	Add	ACTIVE	Q1k; Vy
105	SLR-7	Add	ACTIVE	Q1k; Vy
106	SLR-8	Add	ACTIVE	Q1k; Vy
107	SLR-9	Add	ACTIVE	Q2a; Vx
108	SLR-10	Add	ACTIVE	Q2a; Vx
109	SLR-11	Add	ACTIVE	Q2a; Vx
110	SLR-12	Add	ACTIVE	Q2a; Vx
111	SLR-13	Add	ACTIVE	Q2a; Vy
112	SLR-14	Add	ACTIVE	Q2a; Vy
113	SLR-15	Add	ACTIVE	Q2a; Vy
114	SLR-16	Add	ACTIVE	Q2a; Vy
115	SLR-17	Add	ACTIVE	Q2b; Vx
116	SLR-18	Add	ACTIVE	Q2b; Vx
117	SLR-19	Add	ACTIVE	Q2b; Vx
118	SLR-20	Add	ACTIVE	Q2b; Vx
119	SLR-21	Add	ACTIVE	Q2b; Vy
120	SLR-22	Add	ACTIVE	Q2b; Vy
121	SLR-23	Add	ACTIVE	Q2b; Vy
122	SLR-24	Add	ACTIVE	Q2b; Vy
123	SLR-25	Add	ACTIVE	Vx; Q1f
124	SLR-26	Add	ACTIVE	Vx; Q1f
125	SLR-27	Add	ACTIVE	Vx; Q1f
126	SLR-28	Add	ACTIVE	Vx; Q1f
127	SLR-29	Add	ACTIVE	Vy; Q1f
128	SLR-30	Add	ACTIVE	Vy; Q1f
129	SLR-31	Add	ACTIVE	Vy; Q1f
130	SLR-32	Add	ACTIVE	Vy; Q1f
131	SLR-33	Add	ACTIVE	T; Q1f; Vx
132	SLR-34	Add	ACTIVE	T; Q1f; Vx
133	SLR-35	Add	ACTIVE	T; Q1f; Vx
134	SLR-36	Add	ACTIVE	T; Q1f; Vx
135	SLR-37	Add	ACTIVE	T; Q1f; Vy
136	SLR-38	Add	ACTIVE	T; Q1f; Vy
137	SLR-39	Add	ACTIVE	T; Q1f; Vy
138	SLR-40	Add	ACTIVE	T; Q1f; Vy
139	SLR-41	Add	ACTIVE	DT; Q1f; Vx
140	SLR-42	Add	ACTIVE	DT; Q1f; Vx

141	SLR-43	Add	ACTIVE	DT; Q1f; Vx
142	SLR-44	Add	ACTIVE	DT; Q1f; Vx
143	SLR-45	Add	ACTIVE	DT; Q1f; Vy
144	SLR-46	Add	ACTIVE	DT; Q1f; Vy
145	SLR-47	Add	ACTIVE	DT; Q1f; Vy
146	SLR-48	Add	ACTIVE	DT; Q1f; Vy
147	SLQP-1	Add	ACTIVE	
148	SLQP-2	Add	ACTIVE	
149	SLF-1	Add	ACTIVE	Q1f; T
150	SLF-2	Add	ACTIVE	Q1f; T
151	SLF-3	Add	ACTIVE	Vx; T
152	SLF-4	Add	ACTIVE	Vx; T
153	SLF-5	Add	ACTIVE	Vx; T
154	SLF-6	Add	ACTIVE	Vx; T
155	SLF-7	Add	ACTIVE	Vy; T
156	SLF-8	Add	ACTIVE	Vy; T
157	SLF-9	Add	ACTIVE	Vy; T
158	SLF-10	Add	ACTIVE	Vy; T
159	INVSLU	Envelope	ACTIVE	
160	INVSLU-ap-	Envelope	ACTIVE	
161	INVSLV	Envelope	ACTIVE	
162	INVSLEP	Envelope	ACTIVE	
163	INVSLEQP	Envelope	ACTIVE	
164	INVSLEF	Envelope	ACTIVE	
** STEEL DESIGN				
NO	NAME	TYPE	ACTIVE	DESCRIPTION
1	G1	Add	VERTICAL	
2	G2	Add	VERTICAL	
3	G1+G2	Add	VERTICAL	
4	G1+G2+P	Add	VERTICAL	
5	G1+G2+P+R-	Add	VERTICAL	
6	(G1+G2+P+-	Add	VERTICAL	
7	Q1k	Envelope	SPECIAL	
8	Q2f	Envelope	SPECIAL	
9	q4	Envelope	SPECIAL	
10	Q2a	Add	SPECIAL	
11	Q2b	Add	SPECIAL	
12	SLU-1	Add	ACTIVE	Q1k; +Vx; +T
13	SLU-2	Add	ACTIVE	Q1k; +Vx; -T
14	SLU-3	Add	ACTIVE	Q1k; -Vx; -T
15	SLU-4	Add	ACTIVE	Q1k; -Vx; +T
16	SLU-5	Add	ACTIVE	Q1k; +Vy; +T
17	SLU-6	Add	ACTIVE	Q1k; +Vy; -T
18	SLU-7	Add	ACTIVE	Q1k; -Vy; -T
19	SLU-8	Add	ACTIVE	Q1k; -Vy; +T
20	SLU-9	Add	ACTIVE	Q2a;Vx
21	SLU-10	Add	ACTIVE	Q2a;Vx
22	SLU-11	Add	ACTIVE	Q2a;Vx
23	SLU-12	Add	ACTIVE	Q2a;Vx
24	SLU-13	Add	ACTIVE	Q2a;Vy
25	SLU-14	Add	ACTIVE	Q2a;Vy
26	SLU-15	Add	ACTIVE	Q2a;Vy
27	SLU-16	Add	ACTIVE	Q2a;Vy
28	SLU-17	Add	ACTIVE	Q2b;Vx
29	SLU-18	Add	ACTIVE	Q2b;Vx
30	SLU-19	Add	ACTIVE	Q2b;Vx
31	SLU-20	Add	ACTIVE	Q2b;Vx
32	SLU-21	Add	ACTIVE	Q2b;Vy
33	SLU-22	Add	ACTIVE	Q2b;Vy
34	SLU-23	Add	ACTIVE	Q2b;Vy
35	SLU-24	Add	ACTIVE	Q2b;Vy
36	SLU-25	Add	ACTIVE	Vx
37	SLU-26	Add	ACTIVE	Vx
38	SLU-27	Add	ACTIVE	Vx
39	SLU-28	Add	ACTIVE	Vx
40	SLU-29	Add	ACTIVE	Vy
41	SLU-30	Add	ACTIVE	Vy
42	SLU-31	Add	ACTIVE	Vy
43	SLU-32	Add	ACTIVE	Vy
44	SLU-33	Add	ACTIVE	T; Vx
45	SLU-34	Add	ACTIVE	T; Vx
46	SLU-35	Add	ACTIVE	T; Vx
47	SLU-36	Add	ACTIVE	T; Vx
48	SLU-37	Add	ACTIVE	T; Vy
49	SLU-38	Add	ACTIVE	T; Vy
50	SLU-39	Add	ACTIVE	T; Vy
51	SLU-40	Add	ACTIVE	T; Vy
52	SLU-41	Add	ACTIVE	DT; Vx
53	SLU-42	Add	ACTIVE	DT; Vx
54	SLU-43	Add	ACTIVE	DT; Vx
55	SLU-44	Add	ACTIVE	DT; Vx
56	SLU-45	Add	ACTIVE	DT; Vy
57	SLU-46	Add	ACTIVE	DT; Vy
58	SLU-47	Add	ACTIVE	DT; Vy
59	SLU-48	Add	ACTIVE	DT; Vy
60	SLU-49	Add	ACTIVE	DT; Vy per appoggi
61	SLU-50	Add	ACTIVE	DT; Vy per appoggi
62	SLU-51	Add	ACTIVE	DT; Vy per appoggi
63	SLU-52	Add	ACTIVE	DT; Vy per appoggi
64	SLU-53	Add	ACTIVE	Q1 per appoggi
65	SLU-54	Add	ACTIVE	Q2a per appoggi
66	SLU-55	Add	ACTIVE	Q2b per appoggi
67	SLU-56	Add	ACTIVE	Vy per appoggi
68	SLU-57	Add	ACTIVE	Vy per appoggi
69	SLU-58	Add	ACTIVE	Vy per appoggi
70	SLU-59	Add	ACTIVE	Vy per appoggi
71	SLU-60	Add	ACTIVE	T; Vy per appoggi
72	SLU-61	Add	ACTIVE	T; Vy per appoggi
73	SLU-62	Add	ACTIVE	T; Vy per appoggi

74	SLU-63	Add	ACTIVE	T; Vy per appoggi
75	SLV1x	Add	ACTIVE	
76	SLV2x	Add	ACTIVE	
77	SLV3x	Add	ACTIVE	
78	SLV4x	Add	ACTIVE	
79	SLV5x	Add	ACTIVE	
80	SLV6x	Add	ACTIVE	
81	SLV7x	Add	ACTIVE	
82	SLV8x	Add	ACTIVE	
83	SLV1y	Add	ACTIVE	
84	SLV2y	Add	ACTIVE	
85	SLV3y	Add	ACTIVE	
86	SLV4y	Add	ACTIVE	
87	SLV5y	Add	ACTIVE	
88	SLV6y	Add	ACTIVE	
89	SLV7y	Add	ACTIVE	
90	SLV8y	Add	ACTIVE	
91	SLV1z	Add	ACTIVE	
92	SLV2z	Add	ACTIVE	
93	SLV3z	Add	ACTIVE	
94	SLV4z	Add	ACTIVE	
95	SLV5z	Add	ACTIVE	
96	SLV6z	Add	ACTIVE	
97	SLV7z	Add	ACTIVE	
98	SLV8z	Add	ACTIVE	
99	SLR-1	Add	SERVICE	Q1k; Vx
100	SLR-2	Add	SERVICE	Q1k; Vx
101	SLR-3	Add	SERVICE	Q1k; Vx
102	SLR-4	Add	SERVICE	Q1k; Vx
103	SLR-5	Add	SERVICE	Q1k; Vy
104	SLR-6	Add	SERVICE	Q1k; Vy
105	SLR-7	Add	SERVICE	Q1k; Vy
106	SLR-8	Add	SERVICE	Q1k; Vy
107	SLR-9	Add	SERVICE	Q2a; Vx
108	SLR-10	Add	SERVICE	Q2a; Vx
109	SLR-11	Add	SERVICE	Q2a; Vx
110	SLR-12	Add	SERVICE	Q2a; Vx
111	SLR-13	Add	SERVICE	Q2a; Vy
112	SLR-14	Add	SERVICE	Q2a; Vy
113	SLR-15	Add	SERVICE	Q2a; Vy
114	SLR-16	Add	SERVICE	Q2a; Vy
115	SLR-17	Add	SERVICE	Q2b; Vx
116	SLR-18	Add	SERVICE	Q2b; Vx
117	SLR-19	Add	SERVICE	Q2b; Vx
118	SLR-20	Add	SERVICE	Q2b; Vx
119	SLR-21	Add	SERVICE	Q2b; Vy
120	SLR-22	Add	SERVICE	Q2b; Vy
121	SLR-23	Add	SERVICE	Q2b; Vy
122	SLR-24	Add	SERVICE	Q2b; Vy
123	SLR-25	Add	SERVICE	Vx; Q1f
124	SLR-26	Add	SERVICE	Vx; Q1f
125	SLR-27	Add	SERVICE	Vx; Q1f
126	SLR-28	Add	SERVICE	Vx; Q1f
127	SLR-29	Add	SERVICE	Vy; Q1f
128	SLR-30	Add	SERVICE	Vy; Q1f
129	SLR-31	Add	SERVICE	Vy; Q1f
130	SLR-32	Add	SERVICE	Vy; Q1f
131	SLR-33	Add	SERVICE	T; Q1f; Vx
132	SLR-34	Add	SERVICE	T; Q1f; Vx
133	SLR-35	Add	SERVICE	T; Q1f; Vx
134	SLR-36	Add	SERVICE	T; Q1f; Vx
135	SLR-37	Add	SERVICE	T; Q1f; Vy
136	SLR-38	Add	SERVICE	T; Q1f; Vy
137	SLR-39	Add	SERVICE	T; Q1f; Vy
138	SLR-40	Add	SERVICE	T; Q1f; Vy
139	SLR-41	Add	SERVICE	DT; Q1f; Vx
140	SLR-42	Add	SERVICE	DT; Q1f; Vx
141	SLR-43	Add	SERVICE	DT; Q1f; Vx
142	SLR-44	Add	SERVICE	DT; Q1f; Vx
143	SLR-45	Add	SERVICE	DT; Q1f; Vy
144	SLR-46	Add	SERVICE	DT; Q1f; Vy
145	SLR-47	Add	SERVICE	DT; Q1f; Vy
146	SLR-48	Add	SERVICE	DT; Q1f; Vy
147	SLQP-1	Add	SERVICE	
148	SLQP-2	Add	SERVICE	
149	SLF-1	Add	SERVICE	Q1f; T
150	SLF-2	Add	SERVICE	Q1f; T
151	SLF-3	Add	SERVICE	Vx; T
152	SLF-4	Add	SERVICE	Vx; T
153	SLF-5	Add	SERVICE	Vx; T
154	SLF-6	Add	SERVICE	Vx; T
155	SLF-7	Add	SERVICE	Vy; T
156	SLF-8	Add	SERVICE	Vy; T
157	SLF-9	Add	SERVICE	Vy; T
158	SLF-10	Add	SERVICE	Vy; T

OUTPUT DEL MODELLO DI CALCOLO

```
*****
**                               Gen 2011                               Modeling, Integrated Design & Analysis Software                               **
**                               GENERAL STRUCTURE DESIGN SYSTEM                                               **
*****
```

```

XXX  XXX  XX  XXXXXXXX  XXXXXXXX  XXXXXXXX
XXXX XXXX  XX  XX  XX  XX  XX  XX  XX
XX  XXX  XX  XX  XX  XX  XX  XX  XX
XX  X  XX  XX  XX  XX  XXXXXXXX  XXXXXXXX
XXX  XX  XXX  XXX  XX  XX  XX  XXX
XXX  XX  XXX  XXX  XX  XXX  XX  XX  XXX
XXX  XX  XXX  XXX  XX  XXX  XX  XX  XXX
XXX  XX  XXX  XXXXXXXX  XXX  XX  XXXXXXXX /Gen

```

Gen 2011

COPYRIGHT (C) SINCE 1989. MIDAS Information Technology Co.,Ltd.
ALL RIGHTS RESERVED. MIDAS TEAM

ANALYSIS RESULT OUTPUT

LOAD SET FOR REACTION OUTPUT - Load Set 1

<< LOAD COMB/CASE/ENVEL ABBREVIATION TABLE >>

ABBREVIATION	FULL NAME	TYPE	DESCRIPTION

No Abbreviation was defined in this Load Set. All names are less than 8 char.'s			

<< SELECTED LOAD CASE/COMBINATION DETAIL LIST >>

[[Selected Load Combinations]]

L. COMB	TYPE	COMBINATION DETAIL					
INVS LU	Gen.Env1	1.000 x SLU-1	, 1.000 x SLU-2	, 1.000 x SLU-3	, 1.000 x SLU-4		
		1.000 x SLU-5	, 1.000 x SLU-6	, 1.000 x SLU-7	, 1.000 x SLU-8		
		1.000 x SLU-9	, 1.000 x SLU-10	, 1.000 x SLU-11	, 1.000 x SLU-12		
		1.000 x SLU-13	, 1.000 x SLU-14	, 1.000 x SLU-15	, 1.000 x SLU-16		
		1.000 x SLU-17	, 1.000 x SLU-18	, 1.000 x SLU-19	, 1.000 x SLU-20		
		1.000 x SLU-21	, 1.000 x SLU-22	, 1.000 x SLU-23	, 1.000 x SLU-24		
		1.000 x SLU-25	, 1.000 x SLU-26	, 1.000 x SLU-27	, 1.000 x SLU-28		
		1.000 x SLU-29	, 1.000 x SLU-30	, 1.000 x SLU-31	, 1.000 x SLU-32		
		1.000 x SLU-33	, 1.000 x SLU-34	, 1.000 x SLU-35	, 1.000 x SLU-36		
		1.000 x SLU-37	, 1.000 x SLU-38	, 1.000 x SLU-39	, 1.000 x SLU-40		
		1.000 x SLU-41	, 1.000 x SLU-42	, 1.000 x SLU-43	, 1.000 x SLU-44		
		1.000 x SLU-45	, 1.000 x SLU-46	, 1.000 x SLU-47	, 1.000 x SLU-48		
		1.000 x SLU-49	, 1.000 x SLU-50	, 1.000 x SLU-51	, 1.000 x SLU-52		
		1.000 x SLU-53	, 1.000 x SLU-54	, 1.000 x SLU-55	, 1.000 x SLU-56		
		1.000 x SLU-57	, 1.000 x SLU-58	, 1.000 x SLU-59	, 1.000 x SLU-60		
		1.000 x SLU-61	, 1.000 x SLU-62	, 1.000 x SLU-63			
INVS LV	Gen.Env1	1.000 x SLV1x	, 1.000 x SLV2x	, 1.000 x SLV3x	, 1.000 x SLV4x		
		1.000 x SLV5x	, 1.000 x SLV6x	, 1.000 x SLV7y	, 1.000 x SLV8x		
		1.000 x SLV1y	, 1.000 x SLV2y	, 1.000 x SLV3y	, 1.000 x SLV4y		
		1.000 x SLV5y	, 1.000 x SLV6y	, 1.000 x SLV7x	, 1.000 x SLV8y		
		1.000 x SLV1z	, 1.000 x SLV2z	, 1.000 x SLV3z	, 1.000 x SLV4z		
		1.000 x SLV5z	, 1.000 x SLV6z	, 1.000 x SLV7z	, 1.000 x SLV8z		
INVS LR	Gen.Env1	1.000 x SLR-1	, 1.000 x SLR-2	, 1.000 x SLR-3	, 1.000 x SLR-4		
		1.000 x SLR-5	, 1.000 x SLR-6	, 1.000 x SLR-7	, 1.000 x SLR-8		
		1.000 x SLR-9	, 1.000 x SLR-10	, 1.000 x SLR-11	, 1.000 x SLR-12		
		1.000 x SLR-13	, 1.000 x SLR-14	, 1.000 x SLR-15	, 1.000 x SLR-16		
		1.000 x SLR-17	, 1.000 x SLR-18	, 1.000 x SLR-19	, 1.000 x SLR-20		
		1.000 x SLR-21	, 1.000 x SLR-22	, 1.000 x SLR-23	, 1.000 x SLR-24		
		1.000 x SLR-25	, 1.000 x SLR-26	, 1.000 x SLR-27	, 1.000 x SLR-28		
		1.000 x SLR-29	, 1.000 x SLR-30	, 1.000 x SLR-31	, 1.000 x SLR-32		
		1.000 x SLR-33	, 1.000 x SLR-34	, 1.000 x SLR-35	, 1.000 x SLR-36		
		1.000 x SLR-37	, 1.000 x SLR-38	, 1.000 x SLR-39	, 1.000 x SLR-40		
		1.000 x SLR-41	, 1.000 x SLR-42	, 1.000 x SLR-43	, 1.000 x SLR-44		
		1.000 x SLR-45	, 1.000 x SLR-46	, 1.000 x SLR-47	, 1.000 x SLR-48		
		INVS LEQP	Gen.Env1	1.000 x SLQP-1	, 1.000 x SLQP-2		
		INVS LEF	Gen.Env1	1.000 x SLF-1	, 1.000 x SLF-2	, 1.000 x SLF-3	, 1.000 x SLF-4
				1.000 x SLF-5	, 1.000 x SLF-6	, 1.000 x SLF-7	, 1.000 x SLF-8
				1.000 x SLF-9	, 1.000 x SLF-10		

LOAD SET FOR ELEMENT OUTPUT - Load Set 1

<< LOAD COMB/CASE/ENVEL ABBREVIATION TABLE >>

Sovrapasso di ingresso - Ponte strallato - Relazione di calcolo

ABBREVIATION	FULL NAME	TYPE	DESCRIPTION
No Abbreviation was defined in this Load Set. All names are less than 8 char.'s			

<< SELECTED LOAD CASE/COMBINATION DETAIL LIST >>

[[Selected Load Combinations]]

L. COMB	TYPE	COMBINATION DETAIL					
INVS LU	Gen.Env1	1.000 x SLU-1	1.000 x SLU-2	1.000 x SLU-3	1.000 x SLU-4		
		1.000 x SLU-5	1.000 x SLU-6	1.000 x SLU-7	1.000 x SLU-8		
		1.000 x SLU-9	1.000 x SLU-10	1.000 x SLU-11	1.000 x SLU-12		
		1.000 x SLU-13	1.000 x SLU-14	1.000 x SLU-15	1.000 x SLU-16		
		1.000 x SLU-17	1.000 x SLU-18	1.000 x SLU-19	1.000 x SLU-20		
		1.000 x SLU-21	1.000 x SLU-22	1.000 x SLU-23	1.000 x SLU-24		
		1.000 x SLU-25	1.000 x SLU-26	1.000 x SLU-27	1.000 x SLU-28		
		1.000 x SLU-29	1.000 x SLU-30	1.000 x SLU-31	1.000 x SLU-32		
		1.000 x SLU-33	1.000 x SLU-34	1.000 x SLU-35	1.000 x SLU-36		
		1.000 x SLU-37	1.000 x SLU-38	1.000 x SLU-39	1.000 x SLU-40		
		1.000 x SLU-41	1.000 x SLU-42	1.000 x SLU-43	1.000 x SLU-44		
		1.000 x SLU-45	1.000 x SLU-46	1.000 x SLU-47	1.000 x SLU-48		
		1.000 x SLU-49	1.000 x SLU-50	1.000 x SLU-51	1.000 x SLU-52		
		1.000 x SLU-53	1.000 x SLU-54	1.000 x SLU-55	1.000 x SLU-56		
		1.000 x SLU-57	1.000 x SLU-58	1.000 x SLU-59	1.000 x SLU-60		
		1.000 x SLU-61	1.000 x SLU-62	1.000 x SLU-63			
		INVS LV	Gen.Env1	1.000 x SLV1x	1.000 x SLV2x	1.000 x SLV3x	1.000 x SLV4x
				1.000 x SLV5x	1.000 x SLV6x	1.000 x SLV7y	1.000 x SLV8x
				1.000 x SLV1y	1.000 x SLV2y	1.000 x SLV3y	1.000 x SLV4y
				1.000 x SLV5y	1.000 x SLV6y	1.000 x SLV7x	1.000 x SLV8y
				1.000 x SLV1z	1.000 x SLV2z	1.000 x SLV3z	1.000 x SLV4z
1.000 x SLV5z	1.000 x SLV6z			1.000 x SLV7z	1.000 x SLV8z		
INVS LR	Gen.Env1	1.000 x SLR-1	1.000 x SLR-2	1.000 x SLR-3	1.000 x SLR-4		
		1.000 x SLR-5	1.000 x SLR-6	1.000 x SLR-7	1.000 x SLR-8		
		1.000 x SLR-9	1.000 x SLR-10	1.000 x SLR-11	1.000 x SLR-12		
		1.000 x SLR-13	1.000 x SLR-14	1.000 x SLR-15	1.000 x SLR-16		
		1.000 x SLR-17	1.000 x SLR-18	1.000 x SLR-19	1.000 x SLR-20		
		1.000 x SLR-21	1.000 x SLR-22	1.000 x SLR-23	1.000 x SLR-24		
		1.000 x SLR-25	1.000 x SLR-26	1.000 x SLR-27	1.000 x SLR-28		
		1.000 x SLR-29	1.000 x SLR-30	1.000 x SLR-31	1.000 x SLR-32		
		1.000 x SLR-33	1.000 x SLR-34	1.000 x SLR-35	1.000 x SLR-36		
		1.000 x SLR-37	1.000 x SLR-38	1.000 x SLR-39	1.000 x SLR-40		
		1.000 x SLR-41	1.000 x SLR-42	1.000 x SLR-43	1.000 x SLR-44		
		1.000 x SLR-45	1.000 x SLR-46	1.000 x SLR-47	1.000 x SLR-48		
INVS LEQP	Gen.Env1	1.000 x SLQP-1	1.000 x SLQP-2				
INVS LEF	Gen.Env1	1.000 x SLF-1	1.000 x SLF-2	1.000 x SLF-3	1.000 x SLF-4		
		1.000 x SLF-5	1.000 x SLF-6	1.000 x SLF-7	1.000 x SLF-8		
		1.000 x SLF-9	1.000 x SLF-10				

BEAM ELEMENT FORCES & MOMENTS DEFAULT PRINTOUT.

Unit System : kN , m

ELEM	MAT	SEC	LC	PT	AXIAL	SHEAR-y	SHEAR-z	TORSION	MOMENT-y	MOMENT-z	
3	7	67	INVS LU Max	I	-1469.5	-263.5	-106.0	1846.7	3390.8	6809.3	
				J	-2240.8	-258.1	-96.2	1846.7	4910.8	10669.7	
				Min	I	-4977.3	-1015.7	-415.8	480.8	1044.2	-2639.2
					J	-6018.6	-1024.1	-425.5	480.8	1660.7	162.9
				INVS LV Max	I	-1175.8	511.6	503.0	2557.9	2444.3	4504.6
					J	-1947.1	511.6	503.0	2557.9	7478.6	13056.2
			Min		I	-2323.2	-1602.8	-947.1	-567.1	77.2	-2257.0
					J	-3094.5	-1602.8	-947.1	-567.1	-2550.3	-4894.1
			INVS LR Max		I	-1683.5	-252.0	-102.5	1294.1	2524.5	4815.2
					J	-2454.9	-252.0	-97.3	1294.1	3740.9	7898.2
				Min	I	-3642.2	-711.6	-291.3	459.7	1030.2	-1596.3
					J	-4413.5	-717.3	-297.8	459.7	1633.6	309.8
				INVS LEQP Max	I	-1642.0	-631.2	-256.9	1163.9	1279.1	668.4
					J	-2413.3	-631.2	-256.9	1163.9	2684.9	4089.8
			Min		I	-1653.2	-638.0	-259.6	1151.6	1277.9	595.5
					J	-2424.5	-638.0	-259.6	1151.6	2671.3	4053.3
			INVS LEF Max		I	-1795.8	-331.9	-134.5	813.3	1939.0	3328.6
					J	-2567.1	-330.0	-132.3	813.3	2818.5	5498.4
				Min	I	-2948.3	-445.8	-181.4	606.8	1159.2	125.1
					J	-3719.6	-445.8	-181.4	606.8	1890.4	2326.3
				4	7	67	INVS LU Max	I	-1455.3	1042.7	-95.9
J	-2013.1	1048.9						-88.9	882.4	4547.7	538.0
Min	I	-4959.7	242.3					-426.1	-1358.6	1026.7	-7132.8
	J	-5712.8	236.2					-433.1	-1358.6	1470.5	-10032.0
INVS LV Max	I	-1153.5	1416.9					391.0	1407.5	2321.1	1955.8
	J	-1711.4	1416.9					391.0	1407.5	5465.5	3174.3
	Min	I	-2317.5				-344.0	-826.8	-1919.5	161.3	-4400.2
		J									

Sovrapasso di ingresso - Ponte strallato - Relazione di calcolo

			J	-2875.4	-344.0	-826.8	-1919.5	-1274.8	-9824.3	
			INVSLE Max	I	-1674.5	732.0	-95.5	633.2	2557.7	1579.8
				J	-2232.4	736.1	-90.8	633.2	3440.1	307.6
			Min	I	-3628.6	239.3	-299.0	-967.9	962.4	-5062.6
				J	-4186.4	235.3	-303.7	-967.9	1357.7	-7362.8
			INVSLEQP Max	I	-1630.0	622.8	-251.2	-225.1	1256.9	-713.4
				J	-2187.9	622.8	-251.2	-225.1	2245.5	-3154.9
			Min	I	-1640.7	618.5	-253.0	-314.9	1253.7	-795.0
				J	-2198.6	618.5	-253.0	-314.9	2241.8	-3219.6
			INVSLEF Max	I	-1787.7	470.3	-133.2	204.0	1947.4	-170.8
				J	-2345.6	470.3	-131.6	204.0	2581.1	-1690.9
			Min	I	-2935.8	329.2	-191.0	-535.6	1108.2	-3498.9
				J	-3493.7	327.9	-191.0	-535.6	1673.5	-5188.8
75	14	96	INVSLE Max	I	2295.3	109.5	305.7	270.6	1355.6	-1788.3
				J	2527.5	5.2	305.5	270.6	766.1	-1920.9
			Min	I	-9254.9	-601.9	-578.7	-10.4	-1650.9	-11709.2
				J	-9084.5	-680.0	-567.3	-10.4	-484.7	-10219.1
			INVSLE Min	I	2532.1	403.1	188.0	212.0	994.0	220.2
				J	2704.0	328.4	188.0	212.0	784.3	-532.0
			Min	I	-8555.4	-904.6	-259.2	-174.6	-1110.6	-13393.4
				J	-8383.5	-979.3	-259.2	-174.6	-729.9	-11253.5
			INVSLE Max	I	1536.8	20.9	188.5	221.1	993.5	-2255.2
				J	1708.8	-56.1	180.9	221.1	588.1	-2208.6
			Min	I	-6796.4	-353.5	-444.8	120.6	-1242.9	-7436.4
				J	-6624.6	-425.9	-437.2	120.6	-220.7	-6536.4
			INVSLEQP Max	I	-3080.0	-370.8	-125.8	191.7	-99.7	-8350.4
				J	-2908.1	-445.5	-125.8	191.7	202.5	-7368.2
			Min	I	-3142.7	-384.9	-157.4	168.9	-182.0	-8563.3
				J	-2970.8	-459.6	-157.4	168.9	196.0	-7547.2
			INVSLEF Max	I	-82.2	-5.7	52.6	195.0	521.8	-2595.4
				J	89.7	-81.2	52.6	195.0	397.1	-2489.1
			Min	I	-4632.3	-181.0	-294.7	141.1	-743.1	-5055.7
				J	-4460.4	-255.7	-294.7	141.1	-36.0	-4557.7
80	2	84	INVSLE Max	I	78.5	23.6	73.2	0.2	36.6	12.1
				J	78.5	23.3	74.0	0.2	36.3	17.9
			Min	I	-40.6	-34.4	-73.3	-0.1	-36.7	-16.5
				J	-40.6	-34.4	-72.5	-0.1	-37.1	-11.4
			INVSLE Min	I	27.9	13.7	39.5	0.3	19.8	7.0
				J	27.9	13.7	40.1	0.3	20.2	7.6
			Min	I	-68.5	-14.8	-40.8	-0.3	-20.4	-7.2
				J	-68.5	-14.8	-40.2	-0.3	-20.0	-6.7
			INVSLE Max	I	61.7	11.0	54.0	0.1	27.0	6.1
				J	61.7	11.0	54.6	0.1	26.8	13.8
			Min	I	17.7	-26.3	-54.3	-0.1	-27.2	-12.5
				J	17.7	-26.3	-53.7	-0.1	-27.4	-4.9
			INVSLEQP Max	I	29.9	-7.9	-0.9	0.0	-0.5	-3.3
				J	29.9	-7.9	-0.3	0.0	0.2	4.7
			Min	I	14.8	-8.1	-1.0	0.0	-0.6	-3.3
				J	14.8	-8.1	-0.4	0.0	0.1	4.6
			INVSLEF Max	I	52.6	2.5	29.2	0.1	14.6	1.8
				J	52.6	2.5	29.8	0.1	14.5	9.4
			Min	I	28.5	-17.7	-29.6	-0.0	-14.8	-8.3
				J	28.5	-17.7	-29.0	-0.0	-14.9	-0.7
82	2	84	INVSLE Max	I	374.9	23.6	69.4	0.2	34.7	12.1
				J	374.9	23.3	70.2	0.2	35.0	17.9
			Min	I	22.8	-34.4	-70.7	-0.1	-35.4	-16.5
				J	22.8	-34.4	-69.9	-0.1	-35.2	-11.4
			INVSLE Min	I	104.1	13.7	35.9	0.3	18.0	7.0
				J	104.1	13.7	36.5	0.3	18.8	7.6
			Min	I	1.5	-14.8	-38.1	-0.3	-19.0	-7.2
				J	1.5	-14.8	-37.5	-0.3	-18.2	-6.7
			INVSLE Max	I	312.0	11.0	51.1	0.1	25.5	6.1
				J	312.0	11.0	51.7	0.1	25.9	13.8
			Min	I	240.6	-26.3	-52.4	-0.1	-26.2	-12.5
				J	240.6	-26.3	-51.8	-0.1	-25.9	-4.9
			INVSLEQP Max	I	315.3	-7.9	-1.4	0.0	-0.8	-3.3
				J	315.3	-7.9	-0.8	0.0	0.4	4.7
			Min	I	292.4	-8.1	-1.5	0.0	-0.8	-3.3
				J	292.4	-8.1	-0.9	0.0	0.3	4.6
			INVSLEF Max	I	293.0	2.5	27.2	0.1	13.6	1.8
				J	293.0	2.5	27.9	0.1	14.0	9.4
			Min	I	253.4	-17.7	-28.5	-0.0	-14.3	-8.3
				J	253.4	-17.7	-27.9	-0.0	-14.0	-0.7
87	14	101	INVSLE Max	I	1682.9	3.3	523.5	-24.1	1230.2	-1924.0
				J	1885.2	-87.9	521.1	-24.1	166.9	-1819.0
			Min	I	-7988.1	-699.1	-300.6	-268.7	-960.5	-10213.4
				J	-7839.7	-767.5	-300.4	-268.7	-452.7	-8524.5
			INVSLE Min	I	2533.3	268.4	268.6	125.8	1058.8	-467.2
				J	2683.2	203.3	268.6	125.8	564.5	-937.9
			Min	I	-7901.6	-924.7	-184.9	-199.0	-905.2	-11357.2

Sovrappasso di ingresso - Ponte strallato - Relazione di calcolo

			J	-7751.8	-989.8	-184.9	-199.0	-611.8	-9150.4	
			INVSLE Max	I	1118.6	-56.5	403.8	-142.6	930.8	-2210.3
				J	1268.5	-123.8	402.2	-142.6	6.3	-1988.6
			Min	I	-5798.2	-436.5	-153.5	-218.7	-674.7	-6521.0
				J	-5648.3	-499.5	-151.9	-218.7	-353.0	-5450.0
			INVSLEQP Max	I	-2632.0	-445.8	150.2	-185.8	175.8	-7375.1
				J	-2482.1	-511.0	150.2	-185.8	-177.2	-6224.4
			Min	I	-2673.1	-459.5	145.0	-195.5	171.0	-7556.6
				J	-2523.3	-524.6	145.0	-195.5	-185.0	-6373.2
			INVSLEF Max	I	-193.8	-81.7	271.4	-157.5	561.4	-2489.6
				J	-44.0	-147.5	271.4	-157.5	-79.8	-2212.5
			Min	I	-3938.6	-263.6	-32.8	-193.3	-326.8	-4543.8
				J	-3788.7	-328.7	-32.8	-193.3	-259.7	-3871.7
91	14	97	INVSLE Max	I	1533.0	8.6	534.5	-10.4	1171.4	-1920.9
				J	1735.6	-82.6	523.3	-10.4	97.3	-1829.1
			Min	I	-8064.4	-693.0	-317.6	-222.9	-1038.1	-10423.9
				J	-7915.9	-761.4	-317.8	-222.9	-495.7	-8676.4
			INVSLEF Max	I	2235.8	255.8	261.4	110.9	1006.5	-539.3
				J	2385.7	190.7	261.4	110.9	551.6	-974.3
			Min	I	-7907.4	-913.1	-188.2	-157.1	-960.4	-11250.8
				J	-7757.5	-978.2	-188.2	-157.1	-681.4	-9077.2
			INVSLEQP Max	I	972.2	-53.1	411.1	-132.6	880.2	-2201.4
				J	1122.2	-120.4	403.6	-132.6	-57.0	-1990.8
			Min	I	-5880.6	-427.9	-158.3	-180.6	-717.6	-6689.6
				J	-5730.8	-490.8	-150.8	-180.6	-390.5	-5585.1
			INVSLEQP Max	I	-2895.8	-444.3	147.7	-159.9	109.4	-7374.9
				J	-2746.0	-509.4	147.7	-159.9	-242.4	-6227.8
			Min	I	-2954.8	-457.8	140.3	-161.0	94.6	-7556.6
				J	-2804.9	-522.9	140.3	-161.0	-245.4	-6377.1
			INVSLEF Max	I	-327.7	-77.9	274.9	-145.5	522.7	-2488.8
				J	-177.8	-143.7	274.9	-145.5	-131.4	-2220.8
			Min	I	-4034.1	-256.2	-32.8	-163.8	-364.7	-4673.2
				J	-3884.2	-321.3	-32.8	-163.8	-294.2	-3978.3
96	2	84	INVSLE Max	I	66.3	35.3	86.0	0.2	42.9	18.4
				J	66.3	35.3	86.8	0.2	42.4	13.2
			Min	I	-49.2	-25.5	-85.6	-0.2	-42.8	-12.5
				J	-49.2	-25.8	-84.8	-0.2	-43.5	-16.9
			INVSLEF Max	I	17.9	16.4	53.0	0.4	26.5	8.4
				J	17.9	16.4	53.6	0.4	26.8	8.5
			Min	I	-81.2	-16.4	-54.1	-0.4	-27.1	-7.9
				J	-81.2	-16.4	-53.5	-0.4	-26.7	-8.1
			INVSLEQP Max	I	51.1	26.9	63.4	0.2	31.6	14.1
				J	51.1	26.9	64.0	0.2	31.4	6.9
			Min	I	15.5	-12.5	-63.5	-0.1	-31.7	-5.6
				J	15.5	-12.5	-62.9	-0.1	-32.1	-12.8
			INVSLEQP Max	I	16.4	7.1	-1.0	0.0	-0.6	4.3
				J	16.4	7.1	-0.4	0.0	0.2	-2.8
			Min	I	8.0	7.0	-1.1	0.0	-0.6	4.2
				J	8.0	7.0	-0.5	0.0	0.1	-2.8
			INVSLEF Max	I	45.7	17.9	34.7	0.1	17.3	9.5
				J	45.7	17.9	35.3	0.1	17.2	2.4
			Min	I	26.9	-3.5	-34.9	-0.1	-17.5	-1.1
				J	26.9	-3.5	-34.3	-0.1	-17.7	-8.3
98	2	84	INVSLE Max	I	354.1	35.3	81.4	0.2	40.6	18.4
				J	354.1	35.3	82.2	0.2	41.0	13.2
			Min	I	33.2	-25.5	-82.8	-0.2	-41.4	-12.5
				J	33.2	-25.8	-82.0	-0.2	-41.2	-16.9
			INVSLEF Max	I	93.6	16.4	46.6	0.4	23.4	8.4
				J	93.6	16.4	47.2	0.4	24.1	8.5
			Min	I	3.1	-16.4	-48.9	-0.4	-24.4	-7.9
				J	3.1	-16.4	-48.3	-0.4	-23.6	-8.1
			INVSLEQP Max	I	294.5	26.9	60.0	0.2	29.9	14.1
				J	294.5	26.9	60.6	0.2	30.4	6.9
			Min	I	247.3	-12.5	-61.4	-0.1	-30.7	-5.6
				J	247.3	-12.5	-60.8	-0.1	-30.3	-12.8
			INVSLEQP Max	I	299.1	7.1	-1.6	0.0	-0.9	4.3
				J	299.1	7.1	-1.0	0.0	0.5	-2.8
			Min	I	288.2	7.0	-1.8	0.0	-0.9	4.2
				J	288.2	7.0	-1.1	0.0	0.4	-2.8
			INVSLEF Max	I	279.0	17.9	32.3	0.1	16.1	9.5
				J	279.0	17.9	32.9	0.1	16.6	2.4
			Min	I	253.8	-3.5	-33.7	-0.1	-16.9	-1.1
				J	253.8	-3.5	-33.1	-0.1	-16.5	-8.3
103	14	62	INVSLE Max	I	753.0	-83.5	335.0	185.7	769.1	-1827.1
				J	927.5	-162.4	335.1	185.7	370.2	-1527.5
			Min	I	-6666.2	-784.1	-504.3	-10.5	-901.1	-8833.8
				J	-6538.3	-843.4	-502.2	-10.5	-64.8	-6879.6
			INVSLEF Max	I	1993.5	127.5	243.3	109.2	872.6	-846.0
				J	2122.8	71.4	243.3	109.2	427.9	-1016.9
			Min	I	-7074.8	-919.4	-276.3	-99.1	-891.4	-9235.2

Sovrapasso di ingresso - Ponte strallato - Relazione di calcolo

			J	-6945.5	-975.6	-276.3	-99.1	-367.6	-7024.2	
			INVSLE Max	I	427.0	-119.6	162.1	150.7	528.5	-1978.4
				J	556.3	-177.8	160.6	150.7	294.1	-1619.2
			Min	I	-4778.0	-505.0	-385.7	102.3	-673.5	-5688.4
				J	-4648.7	-559.2	-384.3	102.3	89.5	-4410.1
			INVSLEQP Max	I	-2484.4	-508.6	-114.7	130.3	-69.5	-6222.9
				J	-2355.2	-564.8	-114.7	130.3	206.4	-4932.3
			Min	I	-2526.6	-522.1	-116.1	125.3	-72.3	-6371.0
				J	-2397.4	-578.3	-116.1	125.3	206.1	-5047.9
			INVSLEF Max	I	-513.5	-144.0	42.5	137.0	257.9	-2218.6
				J	-384.2	-200.9	42.5	137.0	232.3	-1802.7
			Min	I	-3294.3	-331.8	-258.1	117.0	-396.4	-4048.8
				J	-3165.0	-388.0	-258.1	117.0	140.7	-3183.7
107	14	40	INVSLE Max	I	707.2	-90.6	290.4	210.3	722.2	-1829.4
				J	881.9	-169.5	290.2	210.3	325.7	-1514.7
			Min	I	-6842.5	-753.2	-518.3	-6.5	-970.1	-8595.7
				J	-6714.6	-812.4	-509.6	-6.5	-0.7	-6778.0
			INVSLE Min	I	1916.1	112.6	210.5	136.7	823.6	-933.4
				J	2045.4	56.4	210.5	136.7	443.7	-1055.2
			Min	I	-7256.7	-895.2	-310.9	-124.5	-933.4	-9091.2
				J	-7127.4	-951.4	-310.9	-124.5	-312.4	-6951.7
			INVSLE Max	I	359.0	-126.8	149.5	171.3	487.9	-1993.3
				J	488.4	-185.0	143.6	171.3	261.7	-1612.0
			Min	I	-4969.0	-489.9	-398.7	117.0	-732.3	-5537.3
				J	-4839.9	-544.1	-392.9	117.0	91.8	-4341.3
			INVSLEQP Max	I	-2736.3	-512.5	-144.3	148.8	-135.0	-6219.5
				J	-2607.1	-568.7	-144.3	148.8	211.4	-4919.5
			Min	I	-2794.3	-525.5	-145.9	143.8	-141.4	-6368.2
				J	-2665.0	-581.7	-145.9	143.8	209.1	-5037.0
			INVSLEF Max	I	-612.8	-149.5	31.4	153.5	223.3	-2221.4
				J	-483.5	-206.4	31.4	153.5	208.8	-1792.3
			Min	I	-3450.6	-322.9	-266.3	131.7	-445.5	-3941.8
				J	-3321.3	-379.0	-266.3	131.7	132.6	-3132.1
112	2	84	INVSLE Max	I	184.1	8.0	38.9	2.7	28.8	4.2
				J	184.1	8.0	39.7	2.7	10.9	4.4
			Min	I	98.4	-8.3	-11.2	-0.3	-0.0	-4.2
				J	98.4	-8.7	-10.6	-0.3	-10.5	-3.8
			INVSLE Min	I	170.2	14.7	15.4	0.5	13.2	7.5
				J	170.2	14.7	16.0	0.5	10.0	11.3
			Min	I	72.4	-22.0	-10.4	-0.2	-0.5	-10.7
				J	72.4	-22.0	-9.8	-0.2	-3.0	-7.2
			INVSLE Max	I	167.4	5.7	31.1	2.2	24.0	3.0
				J	167.4	5.7	31.7	2.2	5.2	1.7
			Min	I	114.2	-3.4	6.6	1.4	12.1	-1.7
				J	114.2	-3.4	7.2	1.4	-7.4	-2.6
			INVSLEQP Max	I	252.7	-0.9	21.2	2.0	23.3	-0.1
				J	252.7	-0.9	21.8	2.0	2.3	0.8
			Min	I	252.3	-1.0	20.7	1.9	23.3	-0.2
				J	252.3	-1.0	21.3	1.9	1.8	0.8
			INVSLEF Max	I	152.3	3.2	25.0	2.0	20.8	1.7
				J	152.3	3.2	25.6	2.0	2.1	0.2
			Min	I	124.6	-0.3	12.5	1.6	14.8	-0.1
				J	124.6	-0.3	13.1	1.6	-4.5	-1.4
114	2	84	INVSLE Max	I	223.2	8.0	7.2	2.7	9.0	4.2
				J	223.2	8.0	7.8	2.7	20.4	4.4
			Min	I	135.8	-8.3	-22.2	-0.3	-1.6	-4.2
				J	135.8	-8.7	-21.4	-0.3	1.4	-3.8
			INVSLE Min	I	213.3	14.7	8.6	0.5	9.8	7.5
				J	213.3	14.7	9.2	0.5	9.2	11.3
			Min	I	145.6	-22.0	-8.5	-0.2	0.4	-10.7
				J	145.6	-22.0	-7.9	-0.2	0.3	-7.2
			INVSLE Max	I	199.4	5.7	-5.9	2.2	5.8	3.0
				J	199.4	5.7	-5.3	2.2	17.3	1.7
			Min	I	143.8	-3.4	-17.8	1.4	-0.4	-1.7
				J	143.8	-3.4	-17.2	1.4	11.2	-2.6
			INVSLEQP Max	I	340.9	-0.9	-12.3	2.0	6.8	-0.1
				J	340.9	-0.9	-11.7	2.0	18.8	0.8
			Min	I	339.6	-1.0	-12.5	1.9	6.4	-0.2
				J	339.6	-1.0	-11.9	1.9	18.7	0.8
			INVSLEF Max	I	182.5	3.2	-8.9	2.0	4.1	1.7
				J	182.5	3.2	-8.3	2.0	15.7	0.2
			Min	I	153.9	-0.3	-15.0	1.6	0.9	-0.1
				J	153.9	-0.3	-14.4	1.6	12.6	-1.4
116	2	84	INVSLE Max	I	510.9	18.3	53.4	1.3	23.0	9.0
				J	510.9	18.0	54.2	1.3	13.1	23.5
			Min	I	280.6	-47.0	-29.6	-0.2	-17.0	-23.5
				J	280.6	-47.0	-29.0	-0.2	-30.8	-9.2
			INVSLE Min	I	500.6	11.6	40.9	0.5	18.9	5.8
				J	500.6	11.6	41.5	0.5	14.7	7.5
			Min	I	179.1	-15.7	-33.2	-0.2	-18.2	-8.2

Sovrappasso di ingresso - Ponte strallato - Relazione di calcolo

			J	179.1	-15.7	-32.6	-0.2	-22.3	-5.8	
			INVSLE Max	I	411.3	-4.4	40.7	1.0	16.8	-2.2
				J	411.3	-4.4	41.3	1.0	5.0	18.6
			Min	I	259.1	-37.1	-17.7	0.4	-12.3	-18.6
				J	259.1	-37.1	-17.1	0.4	-24.2	2.2
			INVSLEQP Max	I	527.9	-21.0	14.3	0.8	1.4	-10.8
				J	527.9	-21.0	14.9	0.8	-13.2	10.6
			Min	I	522.9	-21.6	14.3	0.8	1.4	-11.0
				J	522.9	-21.6	14.9	0.8	-13.2	10.3
			INVSLEF Max	I	345.8	-11.4	25.8	0.9	9.3	-5.7
				J	345.8	-11.4	26.4	0.9	-2.2	14.8
			Min	I	274.9	-29.7	-3.3	0.6	-5.2	-14.9
				J	274.9	-29.7	-2.7	0.6	-16.8	5.7
118	2	84	INVSLE Max	I	501.1	18.3	31.0	1.3	13.7	9.0
				J	501.1	18.0	31.8	1.3	13.0	23.5
			Min	I	270.1	-47.0	-34.2	-0.2	-20.8	-23.5
				J	270.1	-47.0	-33.4	-0.2	-19.6	-9.2
			INVSLE Min	I	398.6	11.6	32.9	0.5	14.9	5.8
				J	398.6	11.6	33.5	0.5	13.0	7.5
			Min	I	183.7	-15.7	-29.8	-0.2	-16.5	-8.2
				J	183.7	-15.7	-29.2	-0.2	-18.4	-5.8
			INVSLE Max	I	412.7	-4.4	22.5	1.0	7.7	-2.2
				J	412.7	-4.4	23.1	1.0	8.8	18.6
			Min	I	251.7	-37.1	-25.1	0.4	-16.1	-18.6
				J	251.7	-37.1	-24.5	0.4	-15.1	2.2
			INVSLEQP Max	I	456.9	-21.0	-0.5	0.8	-6.0	-10.8
				J	456.9	-21.0	0.1	0.8	-5.7	10.6
			Min	I	453.9	-21.6	-0.7	0.8	-6.1	-11.0
				J	453.9	-21.6	-0.1	0.8	-5.8	10.3
			INVSLEF Max	I	342.6	-11.4	10.4	0.9	1.6	-5.7
				J	342.6	-11.4	11.0	0.9	2.9	14.8
			Min	I	266.5	-29.7	-13.5	0.6	-10.3	-14.9
				J	266.5	-29.7	-12.9	0.6	-9.1	5.7
119	2	84	INVSLE Max	I	516.7	33.9	20.5	0.7	10.5	17.3
				J	516.7	33.9	21.3	0.7	11.3	10.5
			Min	I	135.1	-19.6	-22.7	-0.1	-10.9	-9.3
				J	135.1	-20.0	-21.9	-0.1	-10.4	-16.6
			INVSLE Min	I	290.1	5.1	62.1	0.5	31.0	2.7
				J	290.1	5.1	62.7	0.5	29.8	5.2
			Min	I	11.6	-9.7	-60.1	-0.3	-30.0	-4.5
				J	11.6	-9.7	-59.5	-0.3	-31.4	-2.4
			INVSLE Max	I	376.5	26.8	14.5	0.5	7.5	13.7
				J	376.5	26.8	15.1	0.5	8.4	0.3
			Min	I	176.6	0.8	-16.6	0.1	-7.9	1.1
				J	176.6	0.8	-16.0	0.1	-7.3	-13.1
			INVSLEQP Max	I	163.4	13.8	-1.2	0.4	-0.2	7.5
				J	163.4	13.8	-0.6	0.4	0.8	-6.0
			Min	I	161.0	13.3	-1.4	0.4	-0.3	7.2
				J	161.0	13.3	-0.8	0.4	0.7	-6.3
			INVSLEF Max	I	286.3	21.5	5.3	0.4	3.0	11.1
				J	286.3	21.5	5.9	0.4	4.0	-2.8
			Min	I	186.9	6.8	-7.8	0.2	-3.5	3.9
				J	186.9	6.8	-7.2	0.2	-2.6	-10.4
120	14	41	INVSLE Max	I	-304.7	-143.5	512.9	-35.0	667.4	-1532.3
				J	-265.2	-161.8	510.2	-35.0	371.1	-1440.6
			Min	I	-5490.3	-787.1	-315.0	-207.0	-439.8	-6783.9
				J	-5461.5	-800.8	-315.0	-207.0	-285.3	-6308.0
			INVSLE Min	I	1193.9	25.3	352.5	39.9	811.8	-1068.7
				J	1223.1	12.3	352.5	39.9	619.5	-1064.6
			Min	I	-6274.6	-880.1	-234.2	-122.0	-638.7	-6942.4
				J	-6245.4	-893.1	-234.2	-122.0	-517.4	-6425.6
			INVSLE Max	I	-386.3	-163.3	395.0	-119.2	509.9	-1632.3
				J	-357.1	-176.8	393.2	-119.2	280.8	-1530.2
			Min	I	-3911.1	-517.4	-190.1	-168.4	-306.8	-4360.2
				J	-3881.9	-530.0	-188.3	-168.4	-201.4	-4046.4
			INVSLEQP Max	I	-2575.0	-540.0	139.7	-153.7	155.2	-4943.0
				J	-2545.8	-553.0	139.7	-153.7	71.4	-4614.9
			Min	I	-2632.2	-552.8	139.1	-158.6	151.8	-5061.2
				J	-2603.0	-565.8	139.1	-158.6	68.3	-4725.4
			INVSLEF Max	I	-957.5	-184.9	257.7	-130.6	312.3	-1808.1
				J	-928.3	-198.0	257.7	-130.6	159.7	-1693.2
			Min	I	-2793.1	-355.9	-62.9	-150.3	-125.8	-3151.5
				J	-2763.9	-369.0	-62.9	-150.3	-90.7	-2934.3
121	2	84	INVSLE Max	I	715.7	33.9	14.9	0.7	7.1	17.3
				J	715.7	33.9	15.5	0.7	14.5	10.5
			Min	I	222.0	-19.6	-28.9	-0.1	-14.0	-9.3
				J	222.0	-20.0	-28.1	-0.1	-8.0	-16.6
			INVSLE Min	I	343.1	5.1	53.1	0.5	26.5	2.7
				J	343.1	5.1	53.7	0.5	27.2	5.2
			Min	I	128.2	-9.7	-54.9	-0.3	-27.4	-4.5

Sovrapasso di ingresso - Ponte strallato - Relazione di calcolo

			J	128.2	-9.7	-54.3	-0.3	-26.9	-2.4	
			INVSLE Max	I	542.0	26.8	6.9	0.5	3.7	13.7
				J	542.0	26.8	7.5	0.5	11.1	0.3
			Min	I	306.4	0.8	-22.2	0.1	-10.7	1.1
				J	306.4	0.8	-21.6	0.1	-3.5	-13.1
			INVSLEQP Max	I	343.9	13.8	-9.0	0.4	-4.1	7.5
				J	343.9	13.8	-8.4	0.4	4.7	-6.0
			Min	I	341.9	13.3	-9.1	0.4	-4.1	7.2
				J	341.9	13.3	-8.5	0.4	4.6	-6.3
			INVSLEF Max	I	435.1	21.5	-1.1	0.4	-0.2	11.1
				J	435.1	21.5	-0.5	0.4	7.3	-2.8
			Min	I	316.3	6.8	-14.3	0.2	-6.7	3.9
				J	316.3	6.8	-13.7	0.2	0.6	-10.4
122	14	63	INVSLE Max	I	-240.7	-161.2	522.8	22.9	680.0	-1580.5
				J	-201.3	-179.4	522.3	22.9	372.2	-1478.2
			Min	I	-5436.1	-800.7	-353.9	-206.1	-512.3	-6783.6
				J	-5407.3	-814.4	-353.9	-206.1	-304.3	-6327.2
			INVSLE Min	I	1418.5	30.4	310.4	97.0	728.0	-1101.3
				J	1447.7	17.4	310.4	97.0	559.5	-1098.3
			Min	I	-6294.9	-893.6	-276.7	-104.9	-707.8	-6983.9
				J	-6265.7	-906.6	-276.7	-104.9	-559.5	-6460.9
			INVSLE Max	I	-319.6	-176.9	399.9	-95.7	514.5	-1672.2
				J	-290.4	-190.3	399.5	-95.7	278.7	-1558.8
			Min	I	-3880.2	-538.2	-170.7	-166.4	-310.7	-4370.6
				J	-3851.1	-550.7	-170.3	-166.4	-213.1	-4064.7
			INVSLEQP Max	I	-2432.6	-553.3	118.3	-129.8	109.7	-4998.0
				J	-2403.5	-566.3	118.3	-129.8	38.8	-4662.0
			Min	I	-2476.8	-566.2	117.2	-135.0	105.3	-5115.4
				J	-2447.7	-579.2	117.2	-135.0	35.0	-4771.7
			INVSLEF Max	I	-898.3	-198.6	268.3	-114.4	319.7	-1848.5
				J	-869.1	-211.8	268.3	-114.4	160.6	-1725.3
			Min	I	-2755.5	-374.1	-48.1	-146.9	-123.4	-3164.4
				J	-2726.3	-387.1	-48.1	-146.9	-96.9	-2951.4
123	2	84	INVSLE Max	I	433.4	3.8	67.9	0.3	31.7	2.1
				J	433.4	3.5	68.7	0.3	27.0	10.1
			Min	I	139.0	-19.1	-57.9	0.0	-31.4	-8.9
				J	139.0	-19.1	-57.1	0.0	-36.6	-1.6
			INVSLE Min	I	244.1	8.6	80.2	0.5	39.6	4.6
				J	244.1	8.6	80.8	0.5	38.2	6.0
			Min	I	54.5	-11.5	-77.9	-0.4	-39.4	-5.5
				J	54.5	-11.5	-77.3	-0.4	-40.9	-4.1
			INVSLE Max	I	332.6	-6.3	50.1	0.2	23.3	-2.7
				J	332.6	-6.3	50.7	0.2	19.1	8.2
			Min	I	206.0	-15.3	-42.5	0.0	-23.2	-7.1
				J	206.0	-15.3	-41.9	0.0	-27.1	3.6
			INVSLEQP Max	I	237.0	-10.9	2.5	0.1	-0.3	-4.8
				J	237.0	-10.9	3.1	0.1	-3.0	6.2
			Min	I	232.3	-11.1	2.5	0.1	-0.3	-4.9
				J	232.3	-11.1	3.1	0.1	-3.1	6.1
			INVSLEF Max	I	277.1	-8.1	28.0	0.1	12.4	-3.6
				J	277.1	-8.1	28.6	0.1	8.7	7.1
			Min	I	211.1	-13.1	-21.4	0.1	-12.4	-6.1
				J	211.1	-13.1	-20.8	0.1	-16.0	4.5
124	14	43	INVSLE Max	I	-1203.3	-257.4	744.0	124.5	92.2	-1126.9
				J	-1170.0	-272.5	743.9	124.5	39.4	-949.6
			Min	I	-4406.1	-897.3	-268.3	-123.9	-296.0	-4836.0
				J	-4381.8	-908.7	-267.2	-123.9	-468.6	-4340.2
			INVSLE Min	I	511.6	-138.8	613.2	20.2	404.8	-856.9
				J	536.3	-149.5	613.2	20.2	92.7	-747.8
			Min	I	-5394.3	-874.0	-107.3	-122.9	-524.1	-4894.3
				J	-5369.7	-884.7	-107.3	-122.9	-515.7	-4388.9
			INVSLE Max	I	-1056.7	-251.7	495.3	97.2	53.1	-1182.8
				J	-1032.0	-262.8	494.5	97.2	-4.6	-1017.5
			Min	I	-3135.2	-621.9	-167.8	-10.4	-229.9	-3116.4
				J	-3110.5	-632.2	-167.0	-10.4	-365.6	-2774.3
			INVSLEQP Max	I	-2525.2	-642.0	302.7	33.4	-117.6	-3581.1
				J	-2500.6	-652.7	302.7	33.4	-297.8	-3192.5
			Min	I	-2581.0	-654.9	300.2	28.6	-119.7	-3666.4
				J	-2556.4	-665.6	300.2	28.6	-301.4	-3270.0
			INVSLEF Max	I	-1307.6	-272.7	331.4	76.2	-11.4	-1323.6
				J	-1283.0	-283.6	331.4	76.2	-75.0	-1145.0
			Min	I	-2336.6	-455.6	-35.6	22.5	-149.9	-2282.3
				J	-2312.0	-466.3	-35.6	22.5	-261.4	-2029.3
125	2	84	INVSLE Max	I	613.1	3.8	63.1	0.3	29.3	2.1
				J	613.1	3.5	63.9	0.3	27.5	10.1
			Min	I	226.6	-19.1	-59.0	0.0	-32.0	-8.9
				J	226.6	-19.1	-58.2	0.0	-34.3	-1.6
			INVSLE Min	I	280.8	8.6	70.8	0.5	34.9	4.6
				J	280.8	8.6	71.4	0.5	34.7	6.0
			Min	I	182.5	-11.5	-71.0	-0.4	-36.0	-5.5

Sovrappasso di ingresso - Ponte strallato - Relazione di calcolo

			J	182.5	-11.5	-70.4	-0.4	-36.2	-4.1	
			INVSLE Max	I	489.4	-6.3	46.4	0.2	21.4	-2.7
				J	489.4	-6.3	47.0	0.2	19.7	8.2
			Min	I	346.4	-15.3	-43.7	0.0	-23.8	-7.1
				J	346.4	-15.3	-43.1	0.0	-25.3	3.6
			INVSLEQP Max	I	444.2	-10.9	-0.4	0.1	-1.7	-4.8
				J	444.2	-10.9	0.2	0.1	-1.6	6.2
			Min	I	440.5	-11.1	-0.4	0.1	-1.7	-4.9
				J	440.5	-11.1	0.2	0.1	-1.7	6.1
			INVSLEF Max	I	423.2	-8.1	25.4	0.1	11.1	-3.6
				J	423.2	-8.1	26.0	0.1	9.7	7.1
			Min	I	349.6	-13.1	-23.4	0.1	-13.5	-6.1
				J	349.6	-13.1	-22.8	0.1	-14.7	4.5
126	14	69	INVSLE Max	I	-1027.5	-230.3	84.3	219.7	120.1	-1100.1
				J	-994.3	-245.5	83.8	219.7	410.8	-952.1
			Min	I	-4267.6	-937.6	-825.6	41.7	-290.5	-4798.3
				J	-4243.3	-949.0	-825.1	41.7	-120.6	-4236.5
			INVSLE Min	I	538.8	-127.0	64.5	110.1	450.1	-829.9
				J	563.4	-137.7	64.5	110.1	471.7	-741.2
			Min	I	-5193.7	-904.7	-667.2	-15.2	-487.0	-4967.1
				J	-5169.1	-915.4	-667.2	-15.2	-146.7	-4430.0
			INVSLE Max	I	-899.8	-230.3	11.5	178.3	62.7	-1178.0
				J	-875.2	-241.5	11.2	178.3	309.3	-1033.0
			Min	I	-2944.7	-629.0	-662.5	124.9	-218.2	-3050.2
				J	-2920.1	-639.2	-662.1	124.9	-61.6	-2672.9
			INVSLEQP Max	I	-2300.6	-626.1	-484.3	165.1	-66.8	-3580.5
				J	-2276.0	-636.8	-484.3	165.1	223.9	-3201.4
			Min	I	-2346.0	-640.0	-486.7	161.1	-68.3	-3665.3
				J	-2321.3	-650.8	-486.7	161.1	223.8	-3277.9
			INVSLEF Max	I	-1167.3	-253.2	-115.3	158.6	-4.4	-1304.5
				J	-1142.7	-263.9	-115.3	158.6	209.5	-1148.2
			Min	I	-2177.6	-454.5	-489.9	134.4	-138.8	-2229.1
				J	-2153.0	-465.2	-489.9	134.4	19.9	-1955.3
127	14	45	INVSLE Max	I	-938.7	-227.6	931.4	-20.8	385.4	-575.4
				J	-911.0	-240.2	933.9	-20.8	207.0	-411.3
			Min	I	-3081.6	-811.5	209.8	-170.0	-66.8	-2748.2
				J	-3061.4	-821.0	209.7	-170.0	-589.3	-2295.3
			INVSLE Min	I	43.8	-161.8	713.5	33.4	361.5	-541.8
				J	64.2	-170.7	713.5	33.4	67.7	-433.8
			Min	I	-3689.8	-743.7	-0.7	-86.2	-196.2	-3002.1
				J	-3669.4	-752.6	-0.7	-86.2	-330.5	-2561.0
			INVSLE Max	I	-776.5	-214.1	713.1	-97.0	291.3	-660.3
				J	-756.1	-223.4	714.7	-97.0	145.3	-519.6
			Min	I	-2071.8	-550.5	210.8	-138.0	-37.7	-1688.9
				J	-2051.4	-559.0	209.1	-138.0	-440.3	-1383.4
			INVSLEQP Max	I	-1666.7	-535.0	439.2	-120.8	125.7	-2241.6
				J	-1646.2	-543.9	439.2	-120.8	-138.0	-1917.7
			Min	I	-1715.8	-547.4	435.9	-125.2	122.6	-2299.0
				J	-1695.4	-556.2	435.9	-125.2	-139.1	-1967.6
			INVSLEF Max	I	-914.3	-233.8	542.0	-105.0	195.7	-746.0
				J	-893.8	-242.8	542.0	-105.0	28.2	-592.4
			Min	I	-1500.7	-400.5	262.5	-124.1	28.9	-1244.4
				J	-1480.3	-409.4	262.5	-124.1	-282.1	-1020.1
128	2	84	INVSLE Max	I	206.8	29.6	87.6	0.3	43.2	15.7
				J	206.8	29.6	88.4	0.3	43.5	9.2
			Min	I	84.8	-17.6	-88.8	-0.1	-44.9	-8.5
				J	84.8	-17.9	-88.0	-0.1	-44.9	-13.9
			INVSLE Min	I	152.0	14.6	79.4	0.5	39.4	7.6
				J	152.0	14.6	80.0	0.5	39.2	8.3
			Min	I	35.5	-15.9	-79.7	-0.4	-40.1	-7.7
				J	35.5	-15.9	-79.1	-0.4	-40.3	-7.0
			INVSLE Max	I	174.7	23.1	64.5	0.3	31.7	12.3
				J	174.7	23.1	65.1	0.3	32.3	2.0
			Min	I	135.0	-2.7	-66.0	-0.0	-33.4	-0.7
				J	135.0	-2.7	-65.4	-0.0	-33.1	-10.8
			INVSLEQP Max	I	207.4	10.3	-2.1	0.1	-1.7	6.0
				J	207.4	10.3	-1.5	0.1	0.2	-4.2
			Min	I	202.3	10.0	-2.2	0.1	-1.7	5.8
				J	202.3	10.0	-1.6	0.1	0.1	-4.3
			INVSLEF Max	I	161.5	17.5	35.0	0.2	17.0	9.4
				J	161.5	17.5	35.6	0.2	17.8	-0.9
			Min	I	139.3	3.1	-37.0	0.0	-18.9	2.2
				J	139.3	3.1	-36.4	0.0	-18.3	-8.1
129	14	71	INVSLE Max	I	-815.9	-242.4	-111.3	45.6	172.2	-656.0
				J	-788.3	-255.0	-110.8	45.6	632.8	-464.9
			Min	I	-3023.9	-835.5	-826.8	-148.6	-256.1	-2929.9
				J	-3003.7	-844.9	-826.7	-148.6	-166.3	-2479.6
			INVSLE Min	I	125.7	-157.7	58.8	53.8	257.9	-592.1
				J	146.1	-166.6	58.8	53.8	356.4	-457.9
			Min	I	-3678.1	-757.5	-674.1	-42.7	-301.3	-3028.2

Sovrappasso di ingresso - Ponte strallato - Relazione di calcolo

			J	-3657.7	-766.4	-674.1	-42.7	-30.4	-2607.4	
			INVSLE Max	I	-686.1	-223.9	-87.6	-48.9	134.5	-734.0
				J	-665.6	-233.2	-87.3	-48.9	479.0	-579.8
			Min	I	-2057.3	-574.9	-605.9	-121.3	-178.2	-1869.8
				J	-2036.9	-583.4	-606.3	-121.3	-109.0	-1562.1
			INVSLEQP Max	I	-1640.4	-539.1	-281.3	-91.2	24.8	-2359.4
				J	-1620.0	-548.0	-281.3	-91.2	195.2	-2033.0
			Min	I	-1682.8	-551.7	-283.7	-96.1	22.6	-2413.7
				J	-1662.4	-560.6	-283.7	-96.1	191.5	-2079.7
			INVSLEF Max	I	-915.4	-243.8	-146.8	-69.6	65.6	-821.8
				J	-895.0	-252.8	-146.8	-69.6	316.4	-654.6
			Min	I	-1491.3	-419.1	-434.6	-105.6	-92.6	-1398.4
				J	-1470.9	-428.0	-434.6	-105.6	3.6	-1169.8
130	2	84	INVSLE Max	I	504.4	29.6	82.5	0.3	40.7	15.7
				J	504.4	29.6	83.1	0.3	42.7	9.2
			Min	I	186.8	-17.6	-87.2	-0.1	-44.1	-8.5
				J	186.8	-17.9	-86.4	-0.1	-42.1	-13.9
			INVSLE Min	I	223.5	14.6	69.7	0.5	34.6	7.6
				J	223.5	14.6	70.4	0.5	35.5	8.3
			Min	I	161.1	-15.9	-72.1	-0.4	-36.4	-7.7
				J	161.1	-15.9	-71.5	-0.4	-35.5	-7.0
			INVSLE Max	I	424.4	23.1	59.0	0.3	28.9	12.3
				J	424.4	23.1	59.6	0.3	31.8	2.0
			Min	I	349.6	-2.7	-65.1	-0.0	-33.0	-0.7
				J	349.6	-2.7	-64.5	-0.0	-30.4	-10.8
			INVSLEQP Max	I	485.9	10.3	-4.4	0.1	-2.8	6.0
				J	485.9	10.3	-3.8	0.1	1.4	-4.2
			Min	I	482.1	10.0	-4.5	0.1	-2.9	5.8
				J	482.1	10.0	-3.9	0.1	1.2	-4.3
			INVSLEF Max	I	391.1	17.5	31.5	0.2	15.2	9.4
				J	391.1	17.5	32.1	0.2	18.2	-0.9
			Min	I	352.1	3.1	-37.7	0.0	-19.2	2.2
				J	352.1	3.1	-37.1	0.0	-16.6	-8.1
131	14	51	INVSLE Max	I	187.5	-29.5	721.5	81.7	301.1	252.0
				J	205.2	-37.1	721.5	81.7	-34.2	280.7
			Min	I	-1142.4	-398.0	110.5	-74.2	24.7	-414.7
				J	-1129.6	-404.2	108.1	-74.2	-147.3	-177.2
			INVSLE Min	I	-351.9	-142.9	633.7	99.3	239.1	14.6
				J	-338.9	-148.6	633.7	99.3	-31.9	108.0
			Min	I	-1027.8	-384.1	263.0	18.1	93.5	-462.0
				J	-1014.8	-389.8	263.0	18.1	-173.8	-235.6
			INVSLEF Max	I	62.7	-70.8	458.8	-11.0	188.4	152.3
				J	75.8	-76.4	460.4	-11.0	-43.0	202.7
			Min	I	-592.0	-247.2	146.7	-52.2	39.7	-146.3
				J	-579.0	-252.9	145.1	-52.2	-98.8	-1.0
			INVSLEQP Max	I	-698.9	-377.6	599.2	19.8	209.9	-213.4
				J	-685.9	-383.2	599.2	19.8	-147.7	15.0
			Min	I	-727.9	-385.5	586.2	14.4	204.3	-227.6
				J	-714.9	-391.2	586.2	14.4	-149.8	5.6
			INVSLEF Max	I	-60.8	-96.9	355.4	-23.0	141.3	96.2
				J	-47.8	-102.6	355.4	-23.0	-52.3	158.3
			Min	I	-403.3	-190.5	188.5	-44.4	58.5	-69.0
				J	-390.3	-196.2	188.5	-44.4	-79.4	46.0
132	2	84	INVSLE Max	I	62.0	23.1	93.5	0.3	46.6	11.8
				J	62.0	22.8	94.3	0.3	45.6	18.9
			Min	I	-25.6	-36.3	-92.4	-0.2	-46.4	-17.4
				J	-25.6	-36.3	-91.7	-0.2	-47.3	-11.1
			INVSLE Min	I	42.6	16.4	68.2	0.5	34.0	8.4
				J	42.6	16.4	68.8	0.5	34.1	9.5
			Min	I	-63.2	-18.5	-69.0	-0.4	-34.6	-9.1
				J	-63.2	-18.5	-68.4	-0.4	-34.6	-8.0
			INVSLEF Max	I	50.2	9.4	69.1	0.2	34.4	5.4
				J	50.2	9.4	69.7	0.2	33.8	14.5
			Min	I	21.8	-27.8	-68.6	-0.1	-34.5	-13.3
				J	21.8	-27.8	-68.0	-0.1	-35.0	-4.0
			INVSLEQP Max	I	35.1	-9.4	-0.9	0.0	-0.7	-4.0
				J	35.1	-9.4	-0.3	0.0	-0.1	5.5
			Min	I	29.4	-9.5	-1.0	0.0	-0.8	-4.0
				J	29.4	-9.5	-0.3	0.0	-0.2	5.4
			INVSLEF Max	I	46.1	1.1	38.2	0.1	19.0	1.2
				J	46.1	1.1	38.8	0.1	18.6	10.2
			Min	I	31.4	-19.3	-38.1	-0.0	-19.2	-9.0
				J	31.4	-19.3	-37.5	-0.0	-19.6	0.1
133	2	84	INVSLE Max	I	337.2	23.1	88.7	0.3	44.2	11.8
				J	337.2	22.8	89.5	0.3	44.6	18.9
			Min	I	58.6	-36.3	-90.4	-0.2	-45.4	-17.4
				J	58.6	-36.3	-89.5	-0.2	-44.9	-11.1
			INVSLE Min	I	108.1	16.4	59.9	0.5	29.8	8.4
				J	108.1	16.4	60.5	0.5	30.7	9.5
			Min	I	24.4	-18.5	-62.2	-0.4	-31.2	-9.1

Sovrapasso di ingresso - Ponte strallato - Relazione di calcolo

			J	24.4	-18.5	-61.6	-0.4	-30.4	-8.0	
			INVSLE Max	I	281.6	9.4	65.4	0.2	32.5	5.4
				J	281.6	9.4	66.0	0.2	33.1	14.5
			Min	I	241.7	-27.8	-67.1	-0.1	-33.7	-13.3
				J	241.7	-27.8	-66.5	-0.1	-33.2	-4.0
			INVSLEQP Max	I	297.0	-9.4	-2.0	0.0	-1.3	-4.0
				J	297.0	-9.4	-1.4	0.0	0.5	5.5
			Min	I	292.1	-9.5	-2.0	0.0	-1.3	-4.0
				J	292.1	-9.5	-1.4	0.0	0.4	5.4
			INVSLEF Max	I	265.5	1.1	35.5	0.1	17.6	1.2
				J	265.5	1.1	36.1	0.1	18.2	10.2
			Min	I	245.3	-19.3	-37.4	-0.0	-18.8	-9.0
				J	245.3	-19.3	-36.7	-0.0	-18.2	0.1
134	14	48	INVSLE Max	I	-27.9	-169.5	529.3	74.1	369.7	-236.8
				J	-5.5	-179.1	529.2	74.1	145.7	-122.9
			Min	I	-2172.6	-577.6	143.6	-23.0	-179.3	-1275.1
				J	-2156.3	-585.4	141.2	-23.0	-392.8	-928.9
			INVSLE Min	I	-176.3	-140.9	448.0	19.9	206.8	-204.8
				J	-159.7	-148.1	448.0	19.9	65.3	-99.5
			Min	I	-2133.1	-547.9	-47.9	-55.2	-105.5	-1545.6
				J	-2116.5	-555.1	-47.9	-55.2	-204.2	-1233.0
			INVSLE Max	I	-96.1	-168.6	366.1	56.6	262.7	-324.4
				J	-79.5	-175.8	367.7	56.6	110.0	-214.9
			Min	I	-1368.5	-401.0	81.9	35.8	-140.7	-763.1
				J	-1352.0	-408.3	80.3	35.8	-287.7	-522.6
			INVSLEQP Max	I	-1067.1	-457.8	90.1	27.8	1.6	-1201.7
				J	-1050.5	-465.0	90.1	27.8	-49.4	-924.7
			Min	I	-1108.9	-467.7	84.8	24.0	1.6	-1232.0
				J	-1092.4	-474.9	84.8	24.0	-52.5	-949.0
			INVSLEF Max	I	-298.8	-186.8	240.2	50.3	149.8	-362.1
				J	-282.2	-194.0	240.2	50.3	39.4	-244.8
			Min	I	-934.7	-302.6	101.7	41.5	-62.3	-586.7
				J	-918.2	-309.8	101.7	41.5	-178.0	-404.4
136	14	77	INVSLE Max	I	170.2	-50.5	-93.4	-66.7	-32.5	-186.0
				J	187.8	-58.2	-92.9	-66.7	157.3	32.1
			Min	I	-1131.6	-403.0	-713.7	-119.4	-288.0	-332.8
				J	-1118.8	-409.2	-713.6	-119.4	15.4	-283.8
			INVSLE Min	I	-343.6	-147.5	-253.0	-34.0	-76.5	13.1
				J	-330.5	-153.2	-253.0	-34.0	180.2	126.1
			Min	I	-1011.9	-390.1	-633.9	-109.7	-235.7	-470.3
				J	-998.8	-395.8	-633.9	-109.7	40.0	-257.0
			INVSLE Max	I	47.3	-89.8	-132.0	-84.0	-44.5	-230.6
				J	60.3	-95.5	-131.7	-84.0	89.8	-87.7
			Min	I	-612.3	-267.0	-444.9	-107.0	-190.0	-316.2
				J	-599.3	-272.6	-445.2	-107.0	28.8	-248.4
			INVSLEQP Max	I	-715.9	-404.9	-568.4	-156.1	-198.9	-524.8
				J	-702.9	-410.6	-568.4	-156.1	145.5	-275.3
			Min	I	-741.8	-412.7	-581.3	-157.5	-203.5	-525.3
				J	-728.7	-418.3	-581.3	-157.5	142.3	-280.5
			INVSLEF Max	I	-80.2	-116.7	-175.7	-88.1	-63.9	-247.4
				J	-67.2	-122.3	-175.7	-88.1	68.3	-129.7
			Min	I	-422.7	-210.4	-340.9	-98.7	-144.2	-287.0
				J	-409.7	-216.0	-340.9	-98.7	38.7	-210.1
138	14	74	INVSLE Max	I	27.8	-94.3	-186.0	100.7	148.6	-97.2
				J	50.1	-104.0	-185.5	100.7	393.0	-11.3
			Min	I	-2043.3	-588.0	-589.0	-20.9	-413.2	-1444.6
				J	-2027.0	-595.7	-589.5	-20.9	-168.7	-1106.1
			INVSLE Min	I	-200.5	-133.7	26.4	53.9	58.0	-239.8
				J	-184.0	-140.9	26.4	53.9	172.8	-150.9
			Min	I	-2003.5	-561.3	-464.3	-55.3	-252.2	-1567.1
				J	-1987.0	-568.5	-464.3	-55.3	-104.1	-1234.4
			INVSLE Max	I	-40.0	-108.0	-126.4	84.4	108.8	-238.8
				J	-23.5	-115.2	-126.1	84.4	283.0	-150.8
			Min	I	-1196.4	-352.1	-422.8	50.3	-302.6	-919.5
				J	-1179.9	-359.3	-423.1	50.3	-116.4	-718.3
			INVSLEQP Max	I	-935.9	-399.3	-152.5	80.7	-74.4	-1302.0
				J	-919.4	-406.5	-152.5	80.7	17.1	-1060.1
			Min	I	-974.0	-411.3	-156.8	77.2	-77.4	-1327.2
				J	-957.5	-418.5	-156.8	77.2	16.7	-1078.0
			INVSLEF Max	I	-219.2	-126.5	-150.4	77.6	31.9	-331.2
				J	-202.7	-133.7	-150.4	77.6	174.4	-242.7
			Min	I	-800.5	-249.6	-292.6	61.4	-184.4	-695.0
				J	-783.9	-256.8	-292.6	61.4	-41.8	-548.1
140	14	61	INVSLE Max	I	-11.1	7.2	2.7	0.0	1.0	2.5
				J	0.0	0.0	0.0	0.0	0.0	-0.0
			Min	I	-15.7	4.1	-2.7	0.0	-1.0	1.4
				J	0.0	-0.0	0.0	0.0	-0.0	-0.0
			INVSLE Min	I	-6.5	21.5	8.5	3.5	6.2	13.6
				J	4.9	16.5	8.5	3.5	0.9	1.1
			Min	I	-16.4	-11.6	-8.5	-3.5	-6.2	-10.1

Sovrapasso di ingresso - Ponte strallato - Relazione di calcolo

			J	-4.9	-16.5	-8.5	-3.5	-0.9	-1.1	
			INVSLE Max	I	-11.3	5.3	1.8	0.0	0.6	1.8
				J	0.0	0.0	0.0	0.0	0.0	-0.0
			Min	I	-11.6	4.6	-1.8	0.0	-0.6	1.6
				J	0.0	-0.0	0.0	0.0	0.0	-0.0
			INVSLEQP Max	I	-11.4	5.0	-0.0	0.0	-0.0	1.7
				J	0.0	-0.0	0.0	0.0	0.0	-0.0
			Min	I	-11.4	5.0	-0.0	0.0	-0.0	1.7
				J	0.0	-0.0	0.0	0.0	0.0	-0.0
			INVSLEF Max	I	-11.4	5.1	0.6	0.0	0.2	1.8
				J	0.0	0.0	0.0	0.0	0.0	-0.0
			Min	I	-11.5	4.9	-0.6	0.0	-0.2	1.7
				J	0.0	-0.0	0.0	0.0	0.0	-0.0
142	14	80	INVSLE Max	I	-11.1	7.2	0.5	0.0	0.2	2.5
				J	-0.0	-0.0	0.0	0.0	0.0	0.0
			Min	I	-15.7	4.1	-0.5	0.0	-0.2	1.4
				J	-0.0	-0.0	0.0	0.0	0.0	0.0
			INVSLE Min	I	-6.6	21.5	8.4	3.6	6.0	13.6
				J	4.9	16.6	8.4	3.6	0.9	1.0
			Min	I	-16.3	-11.6	-8.4	-3.6	-6.0	-10.1
				J	-4.9	-16.6	-8.4	-3.6	-0.9	-1.0
			INVSLE Max	I	-11.3	5.3	0.4	0.0	0.1	1.8
				J	-0.0	-0.0	0.0	0.0	0.0	0.0
			Min	I	-11.6	4.6	-0.4	0.0	-0.1	1.6
				J	-0.0	-0.0	0.0	0.0	0.0	0.0
			INVSLEQP Max	I	-11.4	5.0	-0.0	0.0	-0.0	1.7
				J	-0.0	-0.0	0.0	0.0	0.0	0.0
			Min	I	-11.4	5.0	-0.0	0.0	-0.0	1.7
				J	-0.0	-0.0	0.0	0.0	0.0	0.0
			INVSLEF Max	I	-11.4	5.1	0.1	0.0	0.0	1.8
				J	-0.0	-0.0	0.0	0.0	0.0	0.0
			Min	I	-11.5	4.9	-0.1	0.0	-0.0	1.7
				J	-0.0	-0.0	0.0	0.0	0.0	0.0
404	11	8	INVSLE Max	I	-955.6	-882.6	1582.1	0.0	0.0	0.0
				J	-960.3	-882.6	1582.1	0.0	386.5	1077.0
			Min	I	-5283.7	-3589.9	-1288.2	0.0	0.0	0.0
				J	-5290.1	-3589.9	-1288.2	0.0	-474.6	264.8
			INVSLE Min	I	-831.9	943.4	900.1	0.0	0.0	0.0
				J	-836.6	943.4	900.1	0.0	226.3	1357.5
			Min	I	-2091.2	-4524.9	-754.2	0.0	0.0	0.0
				J	-2095.9	-4524.9	-754.2	0.0	-270.0	-283.0
			INVSLE Max	I	-1133.3	-836.3	1157.2	0.0	0.0	0.0
				J	-1138.0	-836.3	1157.2	0.0	281.9	762.8
			Min	I	-3843.2	-2542.5	-939.6	0.0	0.0	0.0
				J	-3848.0	-2542.5	-939.6	0.0	-347.2	250.9
			INVSLEQP Max	I	-1325.3	-2142.8	80.4	0.0	0.0	0.0
				J	-1330.0	-2142.8	80.4	0.0	-24.0	655.6
			Min	I	-1333.3	-2185.4	79.9	0.0	0.0	0.0
				J	-1338.0	-2185.4	79.9	0.0	-24.1	642.8
			INVSLEF Max	I	-1516.5	-1081.2	602.5	0.0	0.0	0.0
				J	-1521.2	-1081.2	602.5	0.0	124.3	525.6
			Min	I	-2701.3	-1752.0	-414.4	0.0	0.0	0.0
				J	-2706.0	-1752.0	-414.4	0.0	-180.8	324.4
405	11	8	INVSLE Max	I	-162.8	138.8	341.7	0.0	0.0	0.0
				J	-169.2	138.8	341.7	0.0	233.0	94.6
			Min	I	-2091.5	-315.4	-776.6	0.0	0.0	0.0
				J	-2097.8	-315.4	-776.6	0.0	-102.5	-41.6
			INVSLE Min	I	-169.8	263.6	648.7	0.0	0.0	0.0
				J	-174.5	263.6	648.7	0.0	322.6	131.1
			Min	I	-636.5	-437.0	-1075.4	0.0	0.0	0.0
				J	-641.2	-437.0	-1075.4	0.0	-194.6	-79.1
			INVSLE Max	I	-108.6	94.6	232.9	0.0	0.0	0.0
				J	-113.4	94.6	232.9	0.0	164.9	67.0
			Min	I	-1551.7	-223.3	-549.6	0.0	0.0	0.0
				J	-1556.4	-223.3	-549.6	0.0	-69.9	-28.4
			INVSLEQP Max	I	-366.1	-87.5	-215.4	0.0	0.0	0.0
				J	-370.9	-87.5	-215.4	0.0	76.5	31.1
			Min	I	-369.3	-103.5	-254.9	0.0	0.0	0.0
				J	-374.0	-103.5	-254.9	0.0	64.6	26.2
			INVSLEF Max	I	-203.3	9.8	24.0	0.0	0.0	0.0
				J	-208.0	9.8	24.0	0.0	97.5	39.6
			Min	I	-1015.4	-131.9	-324.8	0.0	0.0	0.0
				J	-1020.1	-131.9	-324.8	0.0	-7.2	-2.9
406	11	8	INVSLE Max	I	-201.2	411.9	-263.5	0.0	0.0	0.0
				J	-207.5	411.9	-263.5	0.0	303.7	-32.2
			Min	I	-2115.1	107.2	-1012.3	0.0	0.0	0.0
				J	-2121.4	107.2	-1012.3	0.0	79.1	-123.6
			INVSLE Min	I	-192.1	570.4	309.3	0.0	0.0	0.0
				J	-196.8	570.4	309.3	0.0	420.2	37.9
			Min	I	-670.0	-126.4	-1400.6	0.0	0.0	0.0

Sovrapasso di ingresso - Ponte strallato - Relazione di calcolo

			J	-674.7	-126.4	-1400.6	0.0	-92.8	-171.1
			INVSLE Max	I	-136.3	288.7	-252.0	0.0	0.0
				J	-141.0	288.7	-252.0	0.0	212.8
			Min	I	-1572.0	102.5	-709.4	0.0	0.0
				J	-1576.7	102.5	-709.4	0.0	75.6
			INVSLEQP Max	I	-400.1	259.6	-631.2	0.0	0.0
				J	-404.8	259.6	-631.2	0.0	191.4
			Min	I	-402.4	256.9	-638.0	0.0	0.0
				J	-407.1	256.9	-638.0	0.0	189.4
			INVSLEF Max	I	-229.2	181.4	-332.6	0.0	0.0
				J	-233.9	181.4	-332.6	0.0	133.7
			Min	I	-1036.6	135.4	-445.8	0.0	0.0
				J	-1041.3	135.4	-445.8	0.0	99.8
407	11	8	INVSLE Max	I	-1106.8	9.3	22.8	0.0	0.0
				J	-1111.5	9.3	22.8	0.0	220.6
			Min	I	-3760.8	-298.6	-735.2	0.0	0.0
				J	-3767.1	-298.6	-735.2	0.0	-6.8
			INVSLE Min	I	-1047.6	66.4	163.4	0.0	0.0
				J	-1052.3	66.4	163.4	0.0	242.9
			Min	I	-2097.7	-328.8	-809.5	0.0	0.0
				J	-2102.4	-328.8	-809.5	0.0	-49.0
			INVSLE Max	I	-1476.3	-9.1	-22.4	0.0	0.0
				J	-1481.0	-9.1	-22.4	0.0	173.6
			Min	I	-2992.8	-235.1	-578.8	0.0	0.0
				J	-2997.5	-235.1	-578.8	0.0	6.7
			INVSLEQP Max	I	-2472.7	-147.7	-363.6	0.0	0.0
				J	-2477.4	-147.7	-363.6	0.0	122.2
			Min	I	-2535.5	-165.5	-407.4	0.0	0.0
				J	-2540.2	-165.5	-407.4	0.0	109.1
			INVSLEF Max	I	-1686.6	-53.8	-132.3	0.0	0.0
				J	-1691.3	-53.8	-132.3	0.0	117.8
			Min	I	-2493.8	-159.4	-392.5	0.0	0.0
				J	-2498.5	-159.4	-392.5	0.0	39.7
408	11	8	INVSLE Max	I	-1100.8	0.0	0.0	0.0	0.0
				J	-1105.5	0.0	0.0	0.0	0.0
			Min	I	-3736.5	0.0	0.0	0.0	0.0
				J	-3742.9	0.0	0.0	0.0	0.0
			INVSLE Min	I	-1060.5	1.8	1.0	0.0	0.0
				J	-1065.2	1.8	1.0	0.0	0.3
			Min	I	-2057.1	-1.8	-1.0	0.0	0.0
				J	-2061.8	-1.8	-1.0	0.0	-0.3
			INVSLE Max	I	-1474.7	0.0	0.0	0.0	0.0
				J	-1479.4	0.0	0.0	0.0	0.0
			Min	I	-2973.0	0.0	0.0	0.0	0.0
				J	-2977.7	0.0	0.0	0.0	0.0
			INVSLEQP Max	I	-2451.3	0.0	0.0	0.0	0.0
				J	-2456.0	0.0	0.0	0.0	0.0
			Min	I	-2514.3	0.0	0.0	0.0	0.0
				J	-2519.0	0.0	0.0	0.0	0.0
			INVSLEF Max	I	-1677.8	0.0	0.0	0.0	0.0
				J	-1682.5	0.0	0.0	0.0	0.0
			Min	I	-2480.6	0.0	0.0	0.0	0.0
				J	-2485.4	0.0	0.0	0.0	0.0
409	11	8	INVSLE Max	I	-1205.0	0.0	2930.5	0.0	0.0
				J	-1209.7	0.0	2930.5	0.0	970.4
			Min	I	-4277.4	0.0	-3234.6	0.0	0.0
				J	-4283.8	0.0	-3234.6	0.0	-879.2
			INVSLE Min	I	-1103.0	0.9	4514.0	0.0	0.0
				J	-1107.7	0.9	4514.0	0.0	1407.9
			Min	I	-2027.7	-0.9	-4692.9	0.0	0.0
				J	-2032.4	-0.9	-4692.9	0.0	-1354.2
			INVSLE Max	I	-1737.9	0.0	2128.4	0.0	0.0
				J	-1742.7	0.0	2128.4	0.0	708.7
			Min	I	-3297.4	0.0	-2362.2	0.0	0.0
				J	-3302.1	0.0	-2362.2	0.0	-638.5
			INVSLEQP Max	I	-2285.9	0.0	-108.0	0.0	0.0
				J	-2290.6	0.0	-108.0	0.0	33.3
			Min	I	-2335.7	0.0	-111.1	0.0	0.0
				J	-2340.4	0.0	-111.1	0.0	32.4
			INVSLEF Max	I	-1999.3	0.0	954.0	0.0	0.0
				J	-2004.0	0.0	954.0	0.0	347.9
			Min	I	-2775.5	0.0	-1159.7	0.0	0.0
				J	-2780.2	0.0	-1159.7	0.0	-286.2
658	2	5	INVSLE Max	I	24.1	2.7	21.3	10.5	67.3
				J	24.5	2.7	28.7	10.5	81.2
			Min	I	-398.1	-3.0	-34.2	-9.3	-62.1
				J	-397.6	-3.0	-24.3	-9.3	-54.9
			INVSLE Min	I	-26.7	0.3	8.6	4.9	29.8
				J	-26.3	0.3	16.0	4.9	14.9
			Min	I	-139.2	-1.4	-8.5	-1.1	-8.6
				J					-3.4

Sovrapasso di ingresso - Ponte strallato - Relazione di calcolo

			J	-138.9	-1.4	-1.1	-1.1	-30.7	-0.9	
			INVSLEP Max	I	-0.3	1.8	8.9	5.9	36.6	4.2
				J	0.1	1.8	16.3	5.9	54.4	4.0
			Min	I	-292.1	-1.7	-23.1	-6.0	-40.6	-4.1
				J	-291.8	-1.7	-15.7	-6.0	-25.3	-4.4
			INVSLEQP Max	I	-45.8	-1.0	5.1	3.7	22.3	-2.5
				J	-45.4	-1.0	12.5	3.7	-19.3	2.5
			Min	I	-93.9	-1.0	4.5	3.5	20.9	-2.6
				J	-93.5	-1.0	11.9	3.5	-20.7	2.3
			INVSLEF Max	I	-66.2	1.1	0.5	2.5	14.5	2.5
				J	-65.8	1.1	7.8	2.5	35.1	1.6
			Min	I	-222.9	-0.7	-16.1	-3.7	-25.6	-1.8
				J	-222.5	-0.7	-8.7	-3.7	-5.8	-2.8
659	2	5	INVSLEP Max	I	37.9	2.9	20.3	9.6	64.7	7.3
				J	38.1	2.9	27.7	9.6	83.3	7.0
			Min	I	-390.8	-2.8	-35.2	-10.1	-64.3	-6.6
				J	-390.5	-2.8	-25.2	-10.1	-52.4	-6.8
			INVSLEP Min	I	-11.3	1.3	8.0	1.5	27.8	3.3
				J	-11.1	1.3	15.4	1.5	18.1	1.3
			Min	I	-124.8	-0.5	-9.7	-4.6	-11.3	-1.0
				J	-124.5	-0.5	-2.3	-4.6	-29.5	-3.1
			INVSLEP Max	I	14.8	1.6	8.3	6.3	34.8	4.0
				J	15.1	1.6	15.7	6.3	56.2	4.7
			Min	I	-285.1	-1.9	-23.9	-5.6	-42.5	-4.4
				J	-284.8	-1.9	-16.5	-5.6	-23.6	-3.7
			INVSLEQP Max	I	-27.8	0.9	3.9	-3.1	19.3	2.3
				J	-27.5	0.9	11.3	-3.1	-16.4	-1.9
			Min	I	-77.3	0.8	3.4	-3.3	18.0	2.2
				J	-77.1	0.8	10.7	-3.3	-17.8	-2.1
			INVSLEF Max	I	-51.0	0.6	-0.3	3.9	12.7	1.6
				J	-50.8	0.6	7.1	3.9	36.8	3.0
			Min	I	-213.5	-1.2	-16.8	-2.2	-27.4	-2.7
				J	-213.3	-1.2	-9.4	-2.2	-4.0	-1.4
674	2	5	INVSLEP Max	I	-73.5	2.1	22.6	10.3	82.4	4.5
				J	-73.1	2.1	29.9	10.3	89.4	6.7
			Min	I	-928.8	-3.0	-27.3	-7.1	-22.1	-7.7
				J	-928.3	-3.0	-17.5	-7.1	-45.1	-5.7
			INVSLEP Min	I	-15.3	0.0	10.7	5.4	39.5	-0.2
				J	-14.9	0.0	18.0	5.4	14.7	3.5
			Min	I	-319.1	-1.5	-4.8	-0.0	7.1	-4.1
				J	-318.7	-1.5	2.5	-0.0	-32.1	-0.5
			INVSLEP Max	I	-123.4	1.3	10.5	5.9	52.4	2.8
				J	-123.0	1.3	17.8	5.9	60.1	3.8
			Min	I	-669.8	-1.7	-18.0	-4.5	-16.0	-4.5
				J	-669.4	-1.7	-10.7	-4.5	-16.5	-3.7
			INVSLEQP Max	I	-98.9	-1.2	7.9	4.4	33.3	-3.2
				J	-98.5	-1.2	15.1	4.4	-20.8	2.7
			Min	I	-144.9	-1.3	7.3	4.2	32.2	-3.4
				J	-144.5	-1.3	14.6	4.2	-22.2	2.5
			INVSLEF Max	I	-176.9	0.8	2.7	2.9	30.5	1.5
				J	-176.5	0.8	10.0	2.9	40.0	1.7
			Min	I	-502.0	-0.8	-12.3	-2.6	-3.4	-2.3
				J	-501.6	-0.8	-5.0	-2.6	-0.3	-2.2
675	2	5	INVSLEP Max	I	-139.0	1.1	18.0	8.4	87.5	1.8
				J	-138.6	1.1	25.3	8.4	77.3	5.2
			Min	I	-1245.9	-2.4	-16.6	-3.8	1.4	-6.5
				J	-1245.4	-2.4	-6.8	-3.8	-27.5	-3.5
			INVSLEP Min	I	-50.7	0.1	4.8	3.2	34.4	-0.1
				J	-50.3	0.1	12.1	3.2	18.8	1.8
			Min	I	-472.1	-0.9	-4.8	-0.2	5.5	-2.7
				J	-471.7	-0.9	2.5	-0.2	-14.0	-0.6
			INVSLEP Max	I	-214.4	0.8	9.1	5.1	63.0	1.4
				J	-214.1	0.8	16.4	5.1	54.9	3.1
			Min	I	-907.5	-1.5	-12.0	-2.7	-0.7	-4.1
				J	-907.1	-1.5	-4.7	-2.7	-6.5	-2.4
			INVSLEQP Max	I	-210.2	-0.4	0.5	1.7	19.3	-1.4
				J	-209.9	-0.4	7.8	1.7	0.2	0.8
			Min	I	-257.3	-0.5	0.2	1.6	18.8	-1.5
				J	-256.9	-0.5	7.5	1.6	-0.8	0.7
			INVSLEF Max	I	-275.3	0.5	2.6	2.6	41.2	0.6
				J	-274.9	0.5	9.9	2.6	39.8	1.4
			Min	I	-686.3	-0.8	-8.8	-1.6	9.0	-2.3
				J	-685.9	-0.8	-1.5	-1.6	6.2	-1.7
676	2	5	INVSLEP Max	I	-161.7	0.3	18.2	8.1	105.0	-0.1
				J	-161.5	0.3	21.9	8.1	67.0	-0.3
			Min	I	-1356.1	-2.4	-7.0	-1.0	12.8	-6.6
				J	-1355.8	-2.4	-2.1	-1.0	10.1	-1.1
			INVSLEP Min	I	-66.9	1.0	3.0	2.7	38.8	0.3
				J	-66.7	1.0	6.6	2.7	30.9	1.5
			Min	I	-539.8	-1.7	-3.8	-0.2	3.7	-2.9

Sovrapasso di ingresso - Ponte strallato - Relazione di calcolo

			J	-539.6	-1.7	-0.2	-0.2	4.7	-2.5	
			INVSLE Max	I	-245.9	0.3	11.7	5.7	76.4	0.2
				J	-245.7	0.3	15.3	5.7	49.0	-0.3
			Min	I	-993.8	-1.7	-6.3	-1.0	10.9	-4.7
				J	-993.6	-1.7	-2.6	-1.0	15.5	-0.9
			INVSLEQP Max	I	-270.8	-0.2	-1.9	0.7	16.3	-0.9
				J	-270.6	-0.2	1.7	0.7	16.8	-0.4
			Min	I	-318.3	-0.2	-2.0	0.7	16.3	-0.9
				J	-318.1	-0.2	1.6	0.7	16.5	-0.5
			INVSLEF Max	I	-314.3	0.1	5.8	3.5	53.7	-0.3
				J	-314.1	0.1	9.5	3.5	37.7	-0.4
			Min	I	-754.2	-1.0	-4.2	-0.3	17.8	-3.1
				J	-754.0	-1.0	-0.6	-0.3	18.6	-0.6
677	2	5	INVSLE Max	I	-138.5	0.1	21.8	9.5	119.1	-0.5
				J	-138.2	0.1	31.7	9.5	32.0	5.9
			Min	I	-1283.5	-2.8	-3.1	-0.4	11.5	-7.8
				J	-1283.0	-2.8	4.2	-0.4	-21.6	-1.2
			INVSLE Min	I	-51.7	0.0	6.3	3.4	47.5	-0.1
				J	-51.3	0.0	13.6	3.4	6.9	1.7
			Min	I	-516.9	-1.0	-3.9	-0.1	2.7	-3.4
				J	-516.5	-1.0	3.4	-0.1	-3.9	-0.6
			INVSLE Max	I	-215.4	-0.1	15.8	6.9	86.9	-0.7
				J	-215.0	-0.1	23.1	6.9	24.2	4.2
			Min	I	-942.0	-2.0	-1.7	0.2	18.5	-5.7
				J	-941.7	-2.0	5.6	0.2	-13.2	-0.5
			INVSLEQP Max	I	-255.5	-0.4	0.3	1.3	22.5	-1.5
				J	-255.1	-0.4	7.6	1.3	3.3	0.3
			Min	I	-302.5	-0.4	0.2	1.3	22.1	-1.5
				J	-302.1	-0.4	7.5	1.3	3.3	0.3
			INVSLEF Max	I	-285.2	-0.2	10.2	4.8	63.8	-1.2
				J	-284.8	-0.2	17.5	4.8	16.9	2.8
			Min	I	-711.1	-1.4	-0.3	0.8	23.9	-4.1
				J	-710.7	-1.4	7.0	0.8	-5.9	0.0
678	2	5	INVSLE Max	I	-84.2	0.4	24.9	9.9	116.6	0.2
				J	-83.8	0.4	34.7	9.9	25.8	6.2
			Min	I	-1090.3	-2.9	-5.3	-1.4	4.5	-8.1
				J	-1089.8	-2.9	2.0	-1.4	-32.1	-1.8
			INVSLE Min	I	-20.8	0.1	7.6	3.6	46.0	-0.1
				J	-20.4	0.1	14.8	3.6	4.9	1.9
			Min	I	-432.9	-1.1	-4.1	-0.2	1.7	-3.5
				J	-432.5	-1.1	3.2	-0.2	-9.1	-0.8
			INVSLE Max	I	-142.1	0.0	18.1	7.2	85.4	-0.6
				J	-141.7	0.0	25.4	7.2	16.4	4.5
			Min	I	-800.5	-2.1	-1.7	-0.0	15.8	-5.9
				J	-800.2	-2.1	5.6	-0.0	-23.2	-0.6
			INVSLEQP Max	I	-197.0	-0.5	1.8	1.7	23.9	-1.8
				J	-196.7	-0.5	9.1	1.7	-1.9	0.5
			Min	I	-241.4	-0.5	1.5	1.6	23.1	-1.9
				J	-241.0	-0.5	8.8	1.6	-2.3	0.5
			INVSLEF Max	I	-209.5	-0.3	12.3	5.3	63.3	-1.4
				J	-209.1	-0.3	19.6	5.3	8.0	3.1
			Min	I	-596.2	-1.6	0.9	1.1	23.9	-4.4
				J	-595.8	-1.6	8.2	1.1	-15.6	0.2
679	2	5	INVSLE Max	I	156.4	1.1	22.7	7.5	96.1	2.1
				J	156.9	1.1	32.6	7.5	31.0	5.5
			Min	I	-608.3	-2.5	-10.5	-4.5	-5.9	-6.6
				J	-607.8	-2.5	-3.2	-4.5	-41.8	-3.3
			INVSLE Min	I	182.1	0.3	6.1	1.9	35.1	0.4
				J	182.5	0.3	13.4	1.9	5.3	1.5
			Min	I	-151.6	-0.8	-5.1	-1.8	-2.3	-2.5
				J	-151.2	-0.8	2.2	-1.8	-12.4	-1.4
			INVSLE Max	I	130.7	0.5	16.6	5.5	70.5	0.8
				J	131.0	0.5	23.9	5.5	15.6	4.0
			Min	I	-439.5	-1.8	-4.7	-2.3	7.8	-4.9
				J	-439.1	-1.8	2.6	-2.3	-30.5	-1.5
			INVSLEQP Max	I	56.0	-0.3	1.8	0.5	19.4	-1.3
				J	56.4	-0.3	9.1	0.5	-6.3	0.3
			Min	I	13.8	-0.4	1.5	0.4	18.5	-1.4
				J	14.2	-0.4	8.8	0.4	-7.1	0.3
			INVSLEF Max	I	66.4	-0.0	11.4	3.7	52.2	-0.4
				J	66.8	-0.0	18.7	3.7	4.3	2.8
			Min	I	-273.2	-1.3	-0.5	-0.7	17.5	-3.6
				J	-272.9	-1.3	6.8	-0.7	-22.1	-0.3
680	2	5	INVSLE Max	I	164.2	2.1	13.1	5.2	54.8	4.8
				J	164.7	2.1	22.9	5.2	49.0	3.5
			Min	I	-489.9	-1.6	-21.0	-7.4	-39.1	-4.1
				J	-489.4	-1.6	-13.7	-7.4	-35.5	-5.6
			INVSLE Min	I	70.0	0.8	0.1	0.9	13.6	1.5
				J	70.4	0.8	7.4	0.9	14.5	0.5
			Min	I	-184.8	-0.3	-10.4	-2.9	-18.8	-1.0

Sovrapasso di ingresso - Ponte strallato - Relazione di calcolo

			J	-184.5	-0.3	-3.1	-2.9	-5.2	-2.6	
			INVSLE Max	I	124.7	1.2	9.0	3.7	39.2	2.7
				J	125.1	1.2	16.3	3.7	25.8	2.4
			Min	I	-363.9	-1.1	-12.5	-4.3	-20.2	-2.9
				J	-363.5	-1.1	-5.2	-4.3	-24.5	-3.3
			INVSLEQP Max	I	-23.5	0.3	-5.2	-1.0	-3.0	0.3
				J	-23.1	0.3	2.1	-1.0	5.5	-1.1
			Min	I	-62.1	0.3	-5.6	-1.1	-4.0	0.1
				J	-61.7	0.3	1.7	-1.1	4.4	-1.2
			INVSLEF Max	I	56.4	0.5	5.2	2.4	26.8	1.0
				J	56.8	0.5	12.5	2.4	10.9	1.5
			Min	I	-240.7	-0.7	-6.6	-1.9	-5.4	-2.1
				J	-240.3	-0.7	0.6	-1.9	-17.3	-1.6
681	2	5	INVSLE Max	I	443.8	3.8	-0.4	0.4	4.5	9.5
				J	444.0	3.8	4.5	0.4	9.3	0.6
			Min	I	-307.5	-0.2	-36.6	-13.3	-87.3	-0.4
				J	-307.3	-0.2	-33.0	-13.3	-20.2	-0.2
			INVSLE Min	I	94.9	2.6	-7.7	-1.8	-10.6	5.1
				J	95.1	2.6	-4.0	-1.8	5.3	1.3
			Min	I	-120.6	-0.0	-22.6	-7.3	-53.0	0.9
				J	-120.4	-0.0	-18.9	-7.3	-4.5	-1.6
			INVSLE Max	I	309.1	2.5	-1.1	0.2	2.0	6.3
				J	309.3	2.5	2.5	0.2	3.8	0.4
			Min	I	-127.6	-0.1	-24.3	-8.8	-60.7	-0.3
				J	-127.5	-0.1	-20.7	-8.8	-13.9	-0.1
			INVSLEQP Max	I	-27.8	1.8	-19.4	-6.0	-41.4	4.2
				J	-27.6	1.8	-15.8	-6.0	1.4	-0.1
			Min	I	-61.5	1.7	-19.9	-6.2	-42.5	4.0
				J	-61.4	1.7	-16.3	-6.2	1.2	-0.1
			INVSLEF Max	I	217.5	1.6	-4.5	-1.1	-7.4	4.0
				J	217.7	1.6	-0.9	-1.1	1.1	0.2
			Min	I	-47.8	0.3	-16.5	-5.6	-39.4	0.6
				J	-47.7	0.3	-12.8	-5.6	-8.9	-0.1
682	2	5	INVSLE Max	I	854.0	4.5	-0.4	-0.2	-17.1	11.8
				J	854.4	4.5	9.4	-0.2	70.6	0.4
			Min	I	-26.2	0.0	-42.2	-15.7	-122.9	0.3
				J	-26.0	0.0	-34.9	-15.7	-43.9	-10.2
			INVSLE Min	I	234.5	2.2	-6.9	-1.7	-14.0	5.9
				J	234.8	2.2	0.4	-1.7	34.2	-1.0
			Min	I	-80.1	0.5	-23.7	-7.9	-63.6	1.1
				J	-79.8	0.5	-16.4	-7.9	1.0	-5.2
			INVSLE Max	I	586.0	3.2	-0.2	0.2	-8.8	8.5
				J	586.2	3.2	7.1	0.2	36.8	0.4
			Min	I	201.8	-0.1	-30.0	-11.2	-92.9	0.0
				J	202.0	-0.1	-22.7	-11.2	-27.4	-7.3
			INVSLEQP Max	I	5.2	1.8	-19.2	-6.1	-45.6	4.6
				J	5.5	1.8	-11.9	-6.1	31.2	-4.0
			Min	I	-23.6	1.7	-19.7	-6.3	-46.4	4.4
				J	-23.3	1.7	-12.4	-6.3	29.7	-4.1
			INVSLEF Max	I	445.4	2.1	-5.0	-1.6	-21.9	5.4
				J	445.7	2.1	2.3	-1.6	17.5	-0.8
			Min	I	234.0	0.4	-19.9	-7.2	-62.2	1.3
				J	234.2	0.4	-12.6	-7.2	-17.4	-4.6
683	2	5	INVSLE Max	I	835.9	0.0	34.4	15.5	69.9	0.4
				J	836.2	0.0	41.7	15.5	-16.7	11.5
			Min	I	-15.3	-4.5	-9.5	0.2	-44.4	-10.0
				J	-15.1	-4.5	0.3	0.2	-121.7	0.2
			INVSLE Min	I	223.8	-0.5	15.3	7.5	31.5	-0.9
				J	224.0	-0.5	22.6	7.5	-14.4	5.5
			Min	I	-63.1	-2.1	-0.2	1.8	1.3	-5.1
				J	-62.9	-2.1	7.1	1.8	-60.8	1.2
			INVSLE Max	I	572.8	0.1	22.4	11.1	36.6	0.5
				J	573.0	0.1	29.7	11.1	-8.3	8.3
			Min	I	211.0	-3.2	-7.3	-0.2	-28.1	-7.2
				J	211.2	-3.2	-0.0	-0.2	-91.9	-0.1
			INVSLEQP Max	I	9.1	-1.7	11.7	6.1	29.6	-3.9
				J	9.3	-1.7	19.0	6.1	-44.1	4.3
			Min	I	-19.8	-1.7	11.3	5.9	28.2	-3.9
				J	-19.6	-1.7	18.6	5.9	-44.7	4.2
			INVSLEF Max	I	437.9	-0.4	12.3	7.1	16.9	-0.8
				J	438.1	-0.4	19.6	7.1	-21.4	5.3
			Min	I	239.8	-2.0	-2.5	1.6	-17.9	-4.5
				J	240.0	-2.0	4.8	1.6	-61.3	1.2
684	2	5	INVSLE Max	I	415.8	0.2	29.2	13.2	78.0	0.4
				J	415.9	0.2	32.8	13.2	9.3	0.4
			Min	I	-268.6	-3.8	-9.3	-0.5	-28.1	-9.1
				J	-268.5	-3.8	-4.4	-0.5	-20.4	-0.2
			INVSLE Min	I	88.6	0.3	14.5	6.9	36.4	-0.5
				J	88.7	0.3	18.2	6.9	5.4	1.2
			Min	I	-99.2	-2.8	0.3	1.9	8.8	-5.8

Sovrapasso di ingresso - Ponte strallato - Relazione di calcolo

			J	-99.1	-2.8	4.0	1.9	-4.9	-1.5	
			INVSLE Max	I	288.8	0.1	17.0	8.7	43.9	0.2
				J	288.8	0.1	20.6	8.7	3.8	0.3
			Min	I	-97.2	-2.5	-6.3	-0.3	-15.6	-6.0
				J	-97.1	-2.5	-2.6	-0.3	-14.1	-0.2
			INVSLEQP Max	I	-19.4	-1.7	12.0	5.9	34.8	-4.2
				J	-19.3	-1.7	15.7	5.9	1.2	-0.1
			Min	I	-53.4	-1.7	11.6	5.8	33.5	-4.2
				J	-53.3	-1.7	15.2	5.8	1.0	-0.2
			INVSLEF Max	I	209.2	-0.3	9.0	5.6	24.9	-0.7
				J	209.3	-0.3	12.7	5.6	1.0	0.1
			Min	I	-29.0	-1.6	-2.8	1.0	-8.2	-3.9
				J	-29.0	-1.6	0.9	1.0	-9.0	-0.1
685	2	5	INVSLE Max	I	133.9	1.6	13.4	7.2	47.9	3.3
				J	134.1	1.6	20.7	7.2	53.7	4.7
			Min	I	-424.2	-2.1	-22.7	-5.2	-35.4	-5.5
				J	-424.1	-2.1	-12.9	-5.2	-38.7	-4.3
			INVSLE Min	I	72.7	0.3	2.4	2.5	12.9	0.4
				J	72.8	0.3	9.7	2.5	13.3	1.3
			Min	I	-158.7	-0.7	-7.5	-1.0	-6.2	-2.3
				J	-158.6	-0.7	-0.2	-1.0	-17.2	-1.2
			INVSLE Max	I	103.3	1.1	5.0	4.2	25.1	2.2
				J	103.4	1.1	12.3	4.2	38.7	2.6
			Min	I	-314.5	-1.2	-16.3	-3.7	-24.7	-3.2
				J	-314.4	-1.2	-9.0	-3.7	-19.9	-3.1
			INVSLEQP Max	I	-7.1	-0.2	-2.4	0.8	3.4	-1.0
				J	-7.0	-0.2	4.9	0.8	-1.8	0.0
			Min	I	-46.1	-0.2	-2.8	0.7	2.5	-1.1
				J	-46.0	-0.2	4.5	0.7	-2.6	-0.1
			INVSLEF Max	I	50.8	0.7	-0.9	1.8	10.2	1.4
				J	50.9	0.7	6.4	1.8	26.5	0.9
			Min	I	-209.0	-0.5	-12.5	-2.5	-17.7	-1.6
				J	-208.9	-0.5	-5.2	-2.5	-5.1	-2.2
686	2	5	INVSLE Max	I	123.1	2.5	3.0	4.4	29.4	5.3
				J	123.2	2.5	10.3	4.4	94.9	2.0
			Min	I	-556.5	-1.1	-32.6	-7.6	-42.6	-3.2
				J	-556.4	-1.1	-22.7	-7.6	-6.4	-6.8
			INVSLE Min	I	172.6	0.8	-2.2	1.7	4.7	1.5
				J	172.7	0.8	5.1	1.7	35.4	0.5
			Min	I	-131.7	-0.3	-13.9	-2.2	-14.6	-1.2
				J	-131.6	-0.3	-6.6	-2.2	-2.9	-2.7
			INVSLE Max	I	104.9	1.8	-2.7	2.3	14.5	3.8
				J	105.0	1.8	4.6	2.3	69.8	0.7
			Min	I	-398.5	-0.5	-24.0	-5.6	-31.3	-1.5
				J	-398.4	-0.5	-16.7	-5.6	7.3	-5.1
			INVSLEQP Max	I	62.9	0.4	-9.2	-0.6	-8.1	0.4
				J	63.0	0.4	-1.9	-0.6	19.4	-1.5
			Min	I	20.2	0.4	-9.5	-0.7	-8.8	0.3
				J	20.2	0.4	-2.2	-0.7	18.7	-1.6
			INVSLEF Max	I	52.2	1.3	-6.9	0.6	3.2	2.7
				J	52.3	1.3	0.4	0.6	51.5	-0.5
			Min	I	-249.4	0.0	-18.7	-3.8	-22.9	-0.3
				J	-249.3	0.0	-11.4	-3.8	17.1	-3.7
687	2	5	INVSLE Max	I	-90.8	2.9	-2.0	1.4	24.6	5.9
				J	-90.8	2.9	5.3	1.4	115.9	0.2
			Min	I	-1016.0	-0.4	-34.9	-10.0	-32.9	-1.9
				J	-1016.0	-0.4	-25.0	-10.0	3.4	-8.3
			INVSLE Min	I	-12.6	1.1	-2.7	0.4	5.5	1.8
				J	-12.6	1.1	4.6	0.4	46.7	0.1
			Min	I	-395.0	-0.1	-15.4	-3.8	-11.1	-0.8
				J	-395.0	-0.1	-8.1	-3.8	-0.2	-3.7
			INVSLE Max	I	-144.7	2.1	-5.6	-0.0	15.5	4.3
				J	-144.7	2.1	1.7	-0.0	84.9	-0.6
			Min	I	-744.2	-0.0	-25.5	-7.3	-23.9	-0.7
				J	-744.2	-0.0	-18.2	-7.3	15.0	-6.1
			INVSLEQP Max	I	-172.3	0.5	-8.9	-1.7	-2.8	0.5
				J	-172.3	0.5	-1.6	-1.7	23.3	-1.9
			Min	I	-217.4	0.5	-9.1	-1.7	-3.0	0.4
				J	-217.4	0.5	-1.8	-1.7	22.7	-1.9
			INVSLEF Max	I	-203.3	1.6	-8.3	-1.1	7.2	3.0
				J	-203.3	1.6	-1.0	-1.1	62.7	-1.4
			Min	I	-555.9	0.3	-19.6	-5.4	-16.2	0.1
				J	-555.9	0.3	-12.3	-5.4	23.3	-4.5
688	2	5	INVSLE Max	I	-135.7	2.8	-4.0	0.4	31.2	5.6
				J	-135.8	2.8	3.3	0.4	118.4	-0.5
			Min	I	-1217.6	-0.2	-31.7	-9.5	-22.1	-1.3
				J	-1217.6	-0.2	-21.9	-9.5	9.8	-7.9
			INVSLE Min	I	-39.9	1.0	-2.8	0.3	7.5	1.5
				J	-39.9	1.0	4.6	0.3	47.6	0.1
			Min	I	-481.8	-0.1	-13.9	-3.5	-4.8	-0.7

Sovrapasso di ingresso - Ponte strallato - Relazione di calcolo

			J	-481.8	-0.1	-6.6	-3.5	0.4	-3.5	
			INVSLE Max	I	-211.3	2.0	-5.5	-0.2	23.6	4.0
				J	-211.4	2.0	1.8	-0.2	86.3	-0.7
			Min	I	-891.9	0.0	-23.1	-6.9	-13.8	-0.6
				J	-891.9	0.0	-15.8	-6.9	17.4	-5.8
			INVSLEQP Max	I	-230.2	0.3	-7.4	-1.3	3.2	0.2
				J	-230.3	0.3	-0.1	-1.3	21.3	-1.5
			Min	I	-278.1	0.3	-7.4	-1.3	3.0	0.2
				J	-278.1	0.3	-0.1	-1.3	21.0	-1.5
			INVSLEF Max	I	-275.5	1.4	-6.9	-0.8	16.4	2.6
				J	-275.5	1.4	0.4	-0.8	63.0	-1.2
			Min	I	-674.2	0.2	-17.4	-4.9	-6.3	-0.1
				J	-674.2	0.2	-10.1	-4.9	23.0	-4.2
689	2	5	INVSLE Max	I	-151.7	2.3	-2.5	1.1	53.1	4.6
				J	-151.8	2.3	2.4	1.1	66.3	-0.4
			Min	I	-1303.3	-0.4	-25.8	-8.0	-19.9	-1.8
				J	-1303.4	-0.4	-21.5	-8.0	9.5	-1.3
			INVSLE Min	I	-52.4	1.3	-1.0	0.4	15.3	1.0
				J	-52.4	1.3	2.7	0.4	30.8	1.3
			Min	I	-510.4	-0.7	-12.1	-2.6	-3.3	-0.7
				J	-510.5	-0.7	-8.4	-2.6	3.8	-2.3
			INVSLE Max	I	-237.2	1.6	-0.7	1.1	39.4	3.3
				J	-237.2	1.6	3.0	1.1	48.4	-0.3
			Min	I	-953.4	-0.4	-18.8	-5.7	-5.9	-1.5
				J	-953.5	-0.4	-15.1	-5.7	15.0	-1.0
			INVSLEQP Max	I	-247.4	0.1	-4.8	-0.5	9.1	-0.2
				J	-247.5	0.1	-1.2	-0.5	16.3	-0.5
			Min	I	-295.9	0.1	-4.9	-0.6	8.5	-0.2
				J	-296.0	0.1	-1.3	-0.6	16.0	-0.5
			INVSLEF Max	I	-302.7	1.0	-2.8	0.4	30.0	1.8
				J	-302.8	1.0	0.9	0.4	37.2	-0.4
			Min	I	-723.8	-0.1	-12.9	-3.5	4.0	-0.9
				J	-723.8	-0.1	-9.2	-3.5	18.2	-0.7
690	2	5	INVSLE Max	I	-123.3	2.4	7.4	3.9	78.3	5.0
				J	-123.4	2.4	17.3	3.9	85.2	2.0
			Min	I	-1209.6	-1.2	-24.6	-8.2	-26.4	-3.8
				J	-1209.8	-1.2	-17.3	-8.2	-0.5	-6.4
			INVSLE Min	I	-35.5	0.8	-2.0	0.4	20.5	1.7
				J	-35.6	0.8	5.3	0.4	32.2	0.0
			Min	I	-448.5	-0.1	-11.4	-3.0	-13.5	-0.9
				J	-448.7	-0.1	-4.1	-3.0	4.1	-2.5
			INVSLE Max	I	-202.0	1.4	5.2	2.8	55.8	2.9
				J	-202.1	1.4	12.5	2.8	61.6	1.5
			Min	I	-879.3	-0.9	-16.0	-5.0	-5.8	-2.7
				J	-879.5	-0.9	-8.7	-5.0	-2.1	-4.0
			INVSLEQP Max	I	-189.4	0.4	-6.8	-1.3	1.5	0.5
				J	-189.5	0.4	0.5	-1.3	17.3	-1.3
			Min	I	-237.7	0.3	-7.1	-1.5	0.5	0.4
				J	-237.8	0.3	0.2	-1.5	16.7	-1.3
			INVSLEF Max	I	-262.7	0.7	2.0	1.7	40.6	1.2
				J	-262.8	0.7	9.3	1.7	39.7	0.7
			Min	I	-664.2	-0.5	-9.4	-2.5	7.0	-1.8
				J	-664.3	-0.5	-2.1	-2.5	7.6	-2.2
691	2	5	INVSLE Max	I	-56.2	2.9	18.3	7.4	91.1	6.4
				J	-56.4	2.9	28.2	7.4	79.6	4.7
			Min	I	-910.5	-2.2	-28.9	-9.9	-43.0	-6.0
				J	-910.8	-2.2	-21.6	-9.9	-24.3	-7.6
			INVSLE Min	I	1.4	1.5	-1.6	0.3	17.5	3.2
				J	1.2	1.5	5.7	0.3	36.4	-0.1
			Min	I	-300.4	-0.1	-17.2	-5.0	-31.0	-0.8
				J	-300.6	-0.1	-9.9	-5.0	5.4	-3.9
			INVSLE Max	I	-109.0	1.6	11.5	4.7	61.6	3.5
				J	-109.2	1.6	18.7	4.7	50.5	3.0
			Min	I	-654.7	-1.4	-17.1	-5.6	-15.0	-3.9
				J	-654.9	-1.4	-9.8	-5.6	-17.9	-4.4
			INVSLEQP Max	I	-78.8	1.1	-13.5	-3.8	-18.2	2.3
				J	-79.1	1.1	-6.2	-3.8	30.4	-3.0
			Min	I	-126.3	1.1	-14.0	-4.0	-19.7	2.2
				J	-126.5	1.1	-6.7	-4.0	29.2	-3.1
			INVSLEF Max	I	-162.3	0.8	5.7	2.8	41.4	1.4
				J	-162.5	0.8	13.0	2.8	28.6	1.7
			Min	I	-487.3	-0.9	-9.3	-2.6	1.2	-2.5
				J	-487.5	-0.9	-2.0	-2.6	-5.2	-2.2
838	14	94	INVSLE Max	I	2859.2	368.3	713.5	240.7	3315.4	-745.8
				J	3097.5	257.8	704.0	240.7	1983.3	-1371.0
			Min	I	-10794.8	-389.7	-862.4	-181.7	-3206.8	-13836.2
				J	-10619.6	-472.4	-852.9	-181.7	-1596.4	-13101.7
			INVSLE Min	I	2480.8	744.8	302.0	214.5	1517.6	2552.4
				J	2657.3	665.2	302.0	214.5	1165.4	1277.2
			Min	I	-9286.0	-822.2	-384.5	-360.5	-1475.5	-17080.0

Sovrapasso di ingresso - Ponte strallato - Relazione di calcolo

			J	-9109.6	-901.9	-384.5	-360.5	-958.2	-15489.2	
			INVSLE Max	I	1951.9	214.2	532.2	191.1	2488.0	-1746.3
				J	2128.4	132.5	525.9	191.1	1501.0	-2088.8
			Min	I	-8057.2	-169.7	-668.6	24.9	-2398.8	-8523.7
				J	-7880.8	-247.4	-662.2	24.9	-1138.1	-8200.8
			INVSLEQP Max	I	-3509.5	-170.4	51.0	84.0	322.3	-9557.7
				J	-3333.1	-250.1	51.0	84.0	278.9	-9136.4
			Min	I	-3590.5	-178.0	-240.6	26.2	-202.3	-9818.4
				J	-3414.0	-257.7	-240.6	26.2	220.3	-9382.0
			INVSLEF Max	I	-16.6	180.7	313.1	154.2	1463.7	-2214.9
				J	159.8	100.4	313.1	154.2	896.8	-2495.3
			Min	I	-5542.4	5.0	-425.0	65.8	-1359.7	-5394.3
				J	-5365.9	-74.7	-425.0	65.8	-568.2	-5395.0
840	14	60	INVSLE Max	I	456.5	42.1	-112.2	7.1	50.6	231.0
				J	470.8	35.7	-114.6	7.1	120.9	218.9
			Min	I	-153.4	10.3	-377.9	-95.7	-222.0	-51.4
				J	-143.0	5.2	-377.9	-95.7	2.4	-60.3
			INVSLEF Max	I	109.7	73.5	-207.8	27.4	-60.4	68.4
				J	120.3	68.8	-207.8	27.4	72.5	63.3
			Min	I	-98.0	-43.5	-372.7	-24.5	-199.5	-29.3
				J	-87.3	-48.1	-372.7	-24.5	16.1	-39.4
			INVSLE Max	I	371.5	33.7	-143.7	-62.0	14.2	187.6
				J	382.1	29.0	-145.3	-62.0	102.6	176.6
			Min	I	91.7	17.7	-267.1	-78.0	-127.8	64.9
				J	102.3	13.1	-265.5	-78.0	30.3	48.2
			INVSLEQP Max	I	271.5	32.9	-470.4	-64.3	-173.7	147.3
				J	282.1	28.2	-470.4	-64.3	108.7	129.0
			Min	I	259.2	32.7	-476.5	-68.3	-177.5	140.8
				J	269.8	28.1	-476.5	-68.3	108.6	122.5
			INVSLEF Max	I	308.4	28.4	-166.8	-65.9	-16.7	161.4
				J	319.0	23.7	-166.8	-65.9	84.4	147.8
			Min	I	156.1	23.5	-232.1	-74.0	-91.5	92.4
				J	166.8	18.9	-232.1	-74.0	46.9	77.8
841	14	52	INVSLE Max	I	355.2	14.8	253.2	54.7	-0.2	254.4
				J	387.2	1.1	253.2	54.7	36.0	246.2
			Min	I	-721.5	-230.6	-41.6	-83.1	-57.7	-235.1
				J	-698.3	-241.9	-46.5	-83.1	-336.5	45.9
			INVSLEF Max	I	-177.9	-65.7	205.0	72.1	5.6	57.7
				J	-154.2	-76.0	205.0	72.1	-113.9	148.7
			Min	I	-621.4	-242.4	80.0	11.1	-83.2	-264.4
				J	-597.8	-252.7	80.0	11.1	-306.1	27.3
			INVSLE Max	I	222.9	-22.0	153.2	-28.2	-9.4	178.3
				J	246.6	-32.2	156.5	-28.2	-12.0	211.8
			Min	I	-305.0	-136.7	-6.5	-60.9	-39.0	-37.8
				J	-281.5	-147.1	-9.8	-60.9	-206.3	129.8
			INVSLEQP Max	I	-330.3	-233.5	195.5	-2.5	-65.6	-35.8
				J	-306.7	-243.8	195.5	-2.5	-295.0	251.0
			Min	I	-351.8	-238.1	191.0	-7.4	-66.0	-46.3
				J	-328.2	-248.4	191.0	-7.4	-300.7	246.1
			INVSLEF Max	I	107.9	-43.0	112.5	-36.8	-16.6	135.2
				J	131.5	-53.3	112.5	-36.8	-53.8	193.2
			Min	I	-171.4	-105.8	25.7	-53.7	-31.4	14.8
				J	-147.8	-116.1	25.7	-53.7	-155.4	146.7
842	14	50	INVSLE Max	I	644.4	-45.8	-68.3	74.1	126.6	66.9
				J	663.2	-54.5	-66.0	74.1	279.7	186.6
			Min	I	-1554.8	-372.9	-479.2	-24.1	-41.4	-467.8
				J	-1541.2	-379.5	-479.2	-24.1	106.4	-320.2
			INVSLEF Max	I	11.6	-85.6	-78.9	24.0	159.4	39.0
				J	25.4	-91.6	-78.9	24.0	293.7	137.0
			Min	I	-1446.7	-386.8	-311.9	-60.6	-70.1	-736.8
				J	-1432.8	-392.8	-311.9	-60.6	30.2	-547.5
			INVSLE Max	I	394.1	-84.4	-62.6	56.5	110.3	-14.9
				J	408.0	-90.8	-61.0	56.5	230.1	103.5
			Min	I	-928.6	-265.3	-346.8	35.9	-8.2	-214.8
				J	-914.7	-271.0	-348.4	35.9	103.4	-117.3
			INVSLEQP Max	I	-723.4	-383.3	-212.2	27.0	118.6	-443.3
				J	-709.5	-389.3	-212.2	27.0	248.1	-211.4
			Min	I	-754.8	-389.4	-217.9	23.2	117.3	-458.5
				J	-740.9	-395.5	-217.9	23.2	246.0	-222.9
			INVSLEF Max	I	103.4	-112.3	-92.4	49.8	87.7	-51.9
				J	117.3	-118.3	-92.4	49.8	181.9	54.8
			Min	I	-575.3	-210.6	-246.9	41.9	22.9	-146.8
				J	-561.5	-216.7	-246.9	41.9	121.6	-51.3
843	14	49	INVSLE Max	I	378.8	-93.2	140.8	80.0	213.1	-138.3
				J	419.9	-110.9	143.2	80.0	77.9	84.0
			Min	I	-1858.8	-469.1	-151.2	-18.9	-255.0	-957.2
				J	-1828.9	-483.3	-156.0	-18.9	-132.8	-432.8
			INVSLEF Max	I	-76.1	-109.8	114.1	24.1	95.5	-120.9
				J	-45.7	-123.0	114.1	24.1	145.4	70.6
			Min	I	-1775.9	-461.7	-132.8	-52.7	-118.4	-1241.3

Sovrappasso di ingresso - Ponte strallato - Relazione di calcolo

			J	-1745.5	-474.9	-132.8	-52.7	-145.8	-730.5	
			INVSLE Max	I	199.0	-118.8	87.7	60.8	157.9	-225.8
				J	229.4	-131.9	90.8	60.8	74.6	-2.6
			Min	I	-1133.9	-322.2	-124.6	38.9	-187.2	-542.8
				J	-1103.6	-335.6	-127.8	38.9	-68.8	-193.5
			INVSLEQP Max	I	-887.3	-415.5	-74.0	30.2	-4.8	-936.1
				J	-856.9	-428.8	-74.0	30.2	85.0	-429.1
			Min	I	-924.6	-423.9	-74.8	26.4	-6.7	-960.8
				J	-894.2	-437.2	-74.8	26.4	82.2	-443.6
			INVSLEF Max	I	-60.1	-138.8	29.4	53.2	83.1	-255.1
				J	-29.7	-152.0	29.4	53.2	56.4	-40.8
			Min	I	-739.1	-247.2	-80.9	44.4	-102.4	-419.2
				J	-708.7	-260.5	-80.9	44.4	-21.0	-131.0
844	14	47	INVSLE Max	I	175.6	-88.0	-56.3	72.7	300.2	-208.6
				J	199.2	-98.9	-53.8	72.7	416.6	-152.4
			Min	I	-2135.2	-559.6	-420.2	-137.5	-400.3	-1522.6
				J	-2118.0	-567.8	-420.2	-137.5	-185.7	-1184.7
			INVSLE Min	I	423.7	-96.5	7.4	95.2	172.2	-284.8
				J	441.2	-104.1	7.4	95.2	312.6	-220.0
			Min	I	-2682.0	-553.0	-318.7	-66.1	-191.5	-1808.8
				J	-2664.5	-560.6	-318.7	-66.1	-145.0	-1479.1
			INVSLE Max	I	60.6	-110.4	-29.6	-24.6	186.2	-327.6
				J	78.1	-118.4	-27.9	-24.6	241.1	-258.8
			Min	I	-1323.4	-356.4	-281.9	-112.6	-301.3	-877.7
				J	-1305.9	-363.6	-283.6	-112.6	-151.1	-661.9
			INVSLEQP Max	I	-975.9	-410.7	-64.2	-78.1	-54.7	-1383.3
				J	-958.4	-418.3	-64.2	-78.1	-14.6	-1134.4
			Min	I	-1017.9	-421.2	-66.8	-83.0	-57.1	-1419.5
				J	-1000.4	-428.8	-66.8	-83.0	-18.6	-1164.3
			INVSLEF Max	I	-194.7	-129.9	-53.4	-50.2	76.5	-376.7
				J	-177.2	-137.5	-53.4	-50.2	131.6	-296.3
			Min	I	-858.9	-257.4	-182.6	-95.7	-189.2	-655.1
				J	-841.4	-265.0	-182.6	-95.7	-88.9	-498.5
845	14	46	INVSLE Max	I	-338.4	-154.0	290.3	39.9	291.2	-409.9
				J	-287.2	-177.5	295.2	39.9	236.4	-194.7
			Min	I	-2505.6	-649.4	-11.6	-148.7	-311.0	-2294.1
				J	-2468.2	-667.1	-11.6	-148.7	-598.5	-1509.8
			INVSLE Min	I	295.2	-115.1	289.1	72.8	176.0	-432.9
				J	333.1	-131.5	289.1	72.8	148.5	-274.9
			Min	I	-3117.6	-630.9	-165.5	-67.4	-190.8	-2559.9
				J	-3079.7	-647.4	-165.5	-67.4	-311.7	-1802.2
			INVSLE Max	I	-309.8	-151.9	218.0	-49.7	215.9	-518.6
				J	-271.9	-169.2	221.3	-49.7	136.2	-317.6
			Min	I	-1616.7	-424.3	28.0	-120.4	-226.2	-1382.5
				J	-1578.9	-439.9	24.7	-120.4	-445.1	-868.0
			INVSLEQP Max	I	-1194.4	-440.9	95.9	-86.8	6.2	-1916.5
				J	-1156.5	-457.4	95.9	-86.8	-108.9	-1377.2
			Min	I	-1240.0	-452.5	95.2	-91.5	4.0	-1966.5
				J	-1202.1	-468.9	95.2	-91.5	-110.3	-1413.3
			INVSLEF Max	I	-505.1	-173.0	159.0	-68.2	111.8	-591.4
				J	-467.3	-189.6	159.0	-68.2	24.3	-368.3
			Min	I	-1106.9	-302.9	58.4	-104.0	-118.7	-1019.3
				J	-1069.0	-319.4	58.4	-104.0	-294.6	-647.4
846	14	44	INVSLE Max	I	-861.7	-187.3	131.1	146.6	128.6	-905.9
				J	-770.4	-229.0	131.0	146.6	702.5	-465.6
			Min	I	-3504.9	-734.7	-377.7	-2.5	-147.0	-4301.6
				J	-3438.2	-766.1	-385.5	-2.5	-288.4	-2989.3
			INVSLE Min	I	875.5	-79.9	200.5	91.6	320.3	-701.9
				J	943.1	-109.3	200.5	91.6	323.7	-487.9
			Min	I	-4661.9	-738.1	-325.3	-68.1	-365.7	-4355.8
				J	-4594.3	-767.5	-325.3	-68.1	-144.3	-3042.3
			INVSLE Max	I	-733.2	-185.4	44.9	122.3	87.3	-981.9
				J	-665.5	-216.1	50.1	122.3	536.0	-593.1
			Min	I	-2469.5	-502.6	-292.0	79.9	-112.3	-2746.1
				J	-2402.1	-530.7	-297.2	79.9	-121.5	-1844.4
			INVSLEQP Max	I	-1779.7	-503.0	-134.8	120.7	-37.7	-3138.1
				J	-1712.2	-532.3	-134.8	120.7	205.0	-2205.1
			Min	I	-1830.6	-514.8	-135.2	116.4	-39.7	-3215.2
				J	-1763.1	-544.2	-135.2	116.4	203.8	-2260.9
			INVSLEF Max	I	-953.3	-206.3	-20.4	110.3	34.4	-1110.6
				J	-885.7	-236.1	-20.4	110.3	369.5	-683.5
			Min	I	-1783.3	-358.1	-206.7	93.3	-56.6	-2002.3
				J	-1715.8	-387.5	-206.7	93.3	13.3	-1345.9
847	14	42	INVSLE Max	I	-259.5	-184.4	489.0	-19.5	339.2	-1441.4
				J	-149.9	-233.7	486.3	-19.5	338.8	-1063.7
			Min	I	-5454.3	-860.5	-324.9	-193.5	-308.0	-6309.8
				J	-5374.1	-897.6	-325.0	-193.5	-615.3	-4728.4
			INVSLE Min	I	1227.4	-57.3	356.8	55.7	581.9	-1064.6
				J	1308.5	-92.3	356.8	55.7	180.0	-893.8
			Min	I	-6239.1	-884.9	-264.8	-109.2	-542.3	-6426.5

Sovrapasso di ingresso - Ponte strallato - Relazione di calcolo

			J	-6158.0	-919.9	-264.8	-109.2	-306.0	-4835.6	
			INVSLE Max	I	-352.2	-194.6	376.4	-110.8	253.2	-1530.8
				J	-271.0	-231.0	374.5	-110.8	183.1	-1146.4
			Min	I	-3877.8	-570.7	-193.9	-156.5	-222.1	-4048.0
				J	-3796.8	-604.2	-192.1	-156.5	-475.6	-2991.2
			INVSLEQP Max	I	-2539.4	-584.8	125.1	-135.6	33.2	-4615.9
				J	-2458.4	-619.8	125.1	-135.6	-192.2	-3530.3
			Min	I	-2596.5	-598.3	124.8	-140.9	31.2	-4726.4
				J	-2515.4	-633.3	124.8	-140.9	-193.7	-3616.4
			INVSLEF Max	I	-924.5	-216.6	244.7	-122.8	138.2	-1693.8
				J	-843.4	-252.0	244.7	-122.8	31.9	-1271.2
			Min	I	-2760.5	-401.4	-69.0	-140.8	-108.2	-2935.7
				J	-2679.5	-436.4	-69.0	-140.8	-314.9	-2181.9
854	14	98	INVSLE Max	I	2901.0	395.1	534.0	467.9	3029.8	-756.1
				J	3139.2	284.6	532.1	467.9	2063.3	-1435.0
			Min	I	-10576.2	-380.0	-1015.8	-29.2	-3462.0	-14228.8
				J	-10401.1	-462.6	-1013.9	-29.2	-1663.3	-13454.5
			INVSLE Min	I	2674.9	737.7	314.7	369.3	1481.6	2658.0
				J	2851.4	658.0	314.7	369.3	1071.7	1399.8
			Min	I	-9140.0	-824.5	-341.6	-184.5	-1510.8	-17278.0
				J	-8963.6	-904.2	-341.6	-184.5	-1046.9	-15685.4
			INVSLE Max	I	2029.7	235.2	394.0	389.3	2259.3	-1744.1
				J	2206.1	153.6	392.8	389.3	1555.6	-2128.8
			Min	I	-7840.5	-139.1	-788.7	124.8	-2605.2	-8804.7
				J	-7664.0	-216.8	-787.4	124.8	-1112.1	-8499.3
			INVSLEQP Max	I	-3171.4	-150.3	-43.5	367.9	111.6	-9573.3
				J	-2994.9	-230.0	-43.5	367.9	267.7	-9192.2
			Min	I	-3232.1	-160.2	-336.1	272.6	-404.7	-9848.5
				J	-3055.7	-239.9	-336.1	272.6	198.5	-9447.6
			INVSLEF Max	I	98.0	204.0	170.8	331.2	1240.9	-2215.5
				J	274.5	123.7	170.8	331.2	968.5	-2542.6
			Min	I	-5355.5	33.6	-563.3	182.8	-1574.1	-5600.0
				J	-5179.0	-46.1	-563.3	182.8	-516.6	-5625.1
856	14	79	INVSLE Max	I	423.8	44.4	393.4	-9.2	230.9	155.3
				J	438.2	39.3	393.4	-9.2	-2.6	131.4
			Min	I	-198.8	4.2	120.7	-81.9	-77.7	-302.8
				J	-188.4	-2.1	121.2	-81.9	-152.4	-304.9
			INVSLE Min	I	104.4	94.0	383.5	1.0	207.9	138.4
				J	115.0	89.4	383.5	1.0	-13.4	93.3
			Min	I	-143.8	-32.9	218.1	-37.2	69.2	-97.2
				J	-133.1	-37.6	218.1	-37.2	-70.7	-86.0
			INVSLE Max	I	338.2	29.8	284.1	-48.8	109.0	-4.8
				J	348.8	25.1	283.8	-48.8	-59.5	-20.4
			Min	I	28.9	6.5	153.2	-70.2	-35.7	-237.2
				J	39.5	1.8	153.5	-70.2	-129.3	-240.8
			INVSLEQP Max	I	199.1	34.6	499.7	-77.4	164.8	-110.4
				J	209.7	30.0	499.7	-77.4	-135.2	-129.7
			Min	I	188.3	34.3	494.0	-80.0	159.5	-118.2
				J	198.9	29.7	494.0	-80.0	-137.1	-137.4
			INVSLEF Max	I	267.1	21.8	246.3	-53.8	71.5	-62.2
				J	277.7	17.1	246.3	-53.8	-75.3	-73.4
			Min	I	102.8	12.9	178.6	-65.1	-4.6	-182.9
				J	113.4	8.3	178.6	-65.1	-112.6	-189.9
857	14	78	INVSLE Max	I	326.9	-2.7	54.7	-53.2	71.6	-20.1
				J	358.8	-16.6	55.7	-53.2	339.2	247.3
			Min	I	-736.8	-223.5	-244.0	-101.7	-13.3	-304.6
				J	-713.6	-234.8	-244.0	-101.7	-64.3	-291.1
			INVSLE Min	I	-173.7	-62.5	-75.1	-34.2	97.4	75.2
				J	-150.1	-72.8	-75.1	-34.2	307.3	222.2
			Min	I	-635.7	-240.0	-198.5	-78.7	2.7	-280.4
				J	-612.1	-250.3	-198.5	-78.7	121.4	-51.4
			INVSLE Max	I	197.0	-37.4	18.3	-76.0	32.9	-122.3
				J	220.6	-47.7	18.9	-76.0	182.6	57.8
			Min	I	-345.0	-149.5	-140.0	-92.0	-0.3	-268.6
				J	-321.4	-159.8	-140.7	-92.0	-11.2	-216.1
			INVSLEQP Max	I	-370.7	-250.9	-173.5	-136.2	67.1	-323.8
				J	-347.0	-261.2	-173.5	-136.2	281.0	-10.9
			Min	I	-389.7	-255.2	-178.1	-138.0	65.5	-327.9
				J	-366.1	-265.5	-178.1	-138.0	273.9	-20.3
			INVSLEF Max	I	77.0	-59.0	-14.6	-79.6	23.1	-157.7
				J	100.6	-69.3	-14.6	-79.6	131.4	-11.1
			Min	I	-206.4	-120.2	-99.5	-86.6	6.9	-230.9
				J	-182.7	-130.5	-99.5	-86.6	30.1	-153.1
858	14	76	INVSLE Max	I	658.5	46.7	455.7	99.1	110.1	-30.2
				J	677.3	38.6	455.7	99.1	6.5	-55.7
			Min	I	-1463.7	-370.6	8.1	-27.5	-101.1	-586.4
				J	-1450.0	-377.1	7.7	-27.5	-258.4	-363.6
			INVSLE Min	I	-20.8	-78.2	295.6	57.8	69.1	-55.4
				J	-6.9	-84.2	295.6	57.8	-16.9	-3.5
			Min	I	-1369.4	-383.7	44.8	-63.5	-159.4	-693.3

Sovrapasso di ingresso - Ponte strallato - Relazione di calcolo

			J	-1355.5	-389.7	44.8	-63.5	-277.8	-464.3	
			INVSLE Max	I	417.8	-9.8	296.5	83.3	71.1	-112.1
				J	431.7	-15.8	296.9	83.3	-6.9	-104.3
			Min	I	-783.5	-207.2	7.9	43.8	-46.9	-427.2
				J	-769.6	-213.3	7.6	43.8	-138.9	-302.2
			INVSLEQP Max	I	-621.4	-321.2	138.8	79.4	-55.5	-649.4
				J	-607.5	-327.2	138.8	79.4	-134.9	-454.7
			Min	I	-650.1	-329.3	132.3	75.8	-58.6	-655.6
				J	-636.2	-335.3	132.3	75.8	-141.9	-456.1
			INVSLEF Max	I	156.0	-42.6	196.7	76.2	40.5	-171.8
				J	169.9	-48.6	196.7	76.2	-24.8	-144.3
			Min	I	-463.2	-151.0	38.7	57.3	-25.2	-340.6
				J	-449.3	-157.0	38.7	57.3	-91.5	-249.1
859	14	75	INVSLE Max	I	411.1	-5.9	101.0	96.1	262.8	-38.6
				J	452.1	-23.7	102.0	96.1	185.4	-7.4
			Min	I	-1749.0	-472.6	-198.8	-33.3	-230.2	-1124.7
				J	-1719.1	-486.8	-199.7	-33.3	-40.9	-559.3
			INVSLEF Max	I	-106.5	-102.5	109.0	52.4	89.3	-168.2
				J	-76.1	-115.7	109.0	52.4	141.2	-32.4
			Min	I	-1672.6	-466.0	-134.6	-63.5	-127.6	-1244.4
				J	-1642.2	-479.2	-134.6	-63.5	-148.8	-681.4
			INVSLE Max	I	237.0	-47.6	78.4	81.2	188.5	-170.5
				J	267.4	-60.8	79.0	81.2	125.9	-95.5
			Min	I	-975.1	-267.9	-141.1	40.6	-161.6	-732.0
				J	-944.7	-281.2	-141.7	40.6	-12.7	-410.1
			INVSLEQP Max	I	-771.0	-354.5	2.0	77.2	-23.3	-1070.5
				J	-740.6	-367.7	2.0	77.2	-25.5	-636.7
			Min	I	-805.1	-365.0	1.8	73.6	-24.9	-1088.7
				J	-774.7	-378.2	1.8	73.6	-27.2	-642.4
			INVSLEF Max	I	4.7	-72.0	33.2	74.1	104.0	-258.1
				J	35.1	-85.3	33.2	74.1	79.9	-158.5
			Min	I	-615.8	-189.6	-79.6	54.7	-83.5	-559.7
				J	-585.4	-202.8	-79.6	54.7	4.6	-327.5
860	14	73	INVSLE Max	I	176.4	-83.4	544.1	-33.5	326.7	-211.0
				J	200.0	-94.3	544.6	-33.5	59.1	-139.9
			Min	I	-2188.1	-555.1	153.3	-195.7	-350.8	-1727.4
				J	-2170.9	-563.3	153.4	-195.7	-506.7	-1402.8
			INVSLEF Max	I	479.4	-85.6	351.4	27.0	183.4	-272.6
				J	496.9	-93.2	351.4	27.0	100.5	-200.4
			Min	I	-2729.6	-549.4	41.7	-105.6	-182.0	-1896.1
				J	-2712.1	-557.0	41.7	-105.6	-335.1	-1582.4
			INVSLE Max	I	60.0	-106.4	404.7	-114.6	217.4	-345.3
				J	77.5	-114.3	405.0	-114.6	-7.6	-265.9
			Min	I	-1392.7	-357.9	133.0	-157.6	-267.1	-1064.4
				J	-1375.3	-365.1	132.6	-157.6	-384.9	-855.6
			INVSLEQP Max	I	-999.1	-405.1	207.7	-137.2	-49.9	-1501.9
				J	-981.6	-412.7	207.7	-137.2	-174.3	-1256.4
			Min	I	-1035.2	-415.9	204.5	-141.6	-51.6	-1534.6
				J	-1017.7	-423.5	204.5	-141.6	-174.6	-1282.5
			INVSLEF Max	I	-210.8	-127.1	297.2	-121.7	104.0	-416.8
				J	-193.4	-134.7	297.2	-121.7	-66.6	-330.9
			Min	I	-908.9	-258.4	157.1	-140.2	-160.7	-804.4
				J	-891.4	-266.0	157.1	-140.2	-277.8	-650.6
861	14	72	INVSLE Max	I	-290.4	-161.3	97.0	-20.1	362.3	-463.2
				J	-239.3	-184.8	98.0	-20.1	511.1	-192.4
			Min	I	-2525.2	-654.1	-166.5	-168.8	-238.0	-2478.5
				J	-2487.8	-671.8	-166.4	-168.8	-287.3	-1718.8
			INVSLEF Max	I	360.2	-105.2	212.8	29.3	226.5	-456.9
				J	398.0	-121.7	212.8	29.3	302.0	-261.5
			Min	I	-3137.7	-635.9	-246.6	-81.0	-132.8	-2606.4
				J	-3099.9	-652.4	-246.6	-81.0	-167.7	-1892.0
			INVSLE Max	I	-274.5	-155.9	84.4	-102.7	271.4	-578.7
				J	-236.6	-173.1	85.1	-102.7	357.2	-331.9
			Min	I	-1662.7	-433.9	-104.9	-138.3	-169.5	-1561.3
				J	-1624.9	-449.6	-105.6	-138.3	-223.5	-1057.7
			INVSLEQP Max	I	-1200.0	-437.6	52.0	-127.5	61.3	-2031.9
				J	-1162.2	-454.1	52.0	-127.5	-1.1	-1496.4
			Min	I	-1239.3	-449.5	51.9	-132.2	58.7	-2078.6
				J	-1201.4	-465.9	51.9	-132.2	-3.6	-1529.0
			INVSLEF Max	I	-511.8	-177.3	50.0	-111.4	159.4	-653.5
				J	-474.0	-193.8	50.0	-111.4	205.7	-406.7
			Min	I	-1141.2	-310.2	-49.3	-126.1	-71.7	-1169.0
				J	-1103.4	-326.7	-49.3	-126.1	-113.5	-798.2
862	14	70	INVSLE Max	I	-654.4	-160.6	240.1	165.1	91.8	-920.9
				J	-563.2	-202.2	240.2	165.1	485.7	-593.3
			Min	I	-3398.4	-759.9	-278.5	-50.0	-198.8	-4177.7
				J	-3331.7	-791.2	-280.1	-50.0	-504.7	-2783.7
			INVSLEF Max	I	878.1	-63.5	273.2	60.2	330.2	-703.0
				J	945.7	-92.9	273.2	60.2	202.1	-540.3
			Min	I	-4488.9	-757.0	-251.3	-97.0	-363.7	-4392.9

Sovrapasso di ingresso - Ponte strallato - Relazione di calcolo

			J	-4421.3	-786.4	-251.3	-97.0	-275.2	-3023.6	
			INVSLE Max	I	-555.2	-161.3	126.8	128.7	65.6	-1004.6
				J	-487.6	-192.0	127.8	128.7	371.3	-685.7
			Min	I	-2302.6	-498.0	-213.0	58.0	-144.9	-2629.5
				J	-2235.1	-526.1	-214.0	58.0	-306.6	-1709.2
			INVSLEQP Max	I	-1585.6	-474.5	-49.4	73.3	-24.9	-3149.1
				J	-1518.1	-503.9	-49.4	73.3	65.0	-2267.4
			Min	I	-1626.4	-487.3	-50.0	68.6	-26.7	-3225.2
				J	-1558.8	-516.7	-50.0	68.6	62.3	-2320.4
			INVSLEF Max	I	-836.0	-182.4	48.4	110.4	13.8	-1120.8
				J	-768.5	-212.2	48.4	110.4	224.9	-764.8
			Min	I	-1644.6	-347.4	-138.0	76.0	-82.8	-1918.4
				J	-1577.0	-376.8	-138.0	76.0	-141.0	-1267.5
863	14	68	INVSLE Max	I	-194.5	-198.2	528.7	5.6	407.4	-1477.3
				J	-85.0	-247.6	527.7	5.6	351.3	-1058.3
			Min	I	-5399.5	-872.2	-328.1	-217.4	-268.3	-6325.7
				J	-5319.3	-909.3	-328.0	-217.4	-623.1	-4863.7
			INVSLE Max	I	1451.8	-45.7	340.3	81.3	593.4	-1098.3
				J	1532.9	-80.7	340.3	81.3	202.5	-915.0
			Min	I	-6258.6	-901.2	-281.0	-116.9	-529.2	-6460.6
				J	-6177.5	-936.1	-281.0	-116.9	-245.2	-4873.9
			INVSLE Max	I	-284.6	-205.6	405.2	-105.1	309.2	-1558.1
				J	-203.5	-242.0	404.6	-105.1	144.7	-1131.0
			Min	I	-3845.8	-589.0	-153.9	-176.5	-187.8	-4062.8
				J	-3764.8	-622.5	-153.2	-176.5	-475.0	-3077.1
			INVSLEQP Max	I	-2396.0	-594.2	132.3	-146.7	80.7	-4661.0
				J	-2314.9	-629.1	132.3	-146.7	-157.7	-3558.6
			Min	I	-2440.0	-607.6	131.0	-151.6	76.1	-4770.7
				J	-2359.0	-642.6	131.0	-151.6	-159.8	-3644.0
			INVSLEF Max	I	-864.5	-228.2	274.5	-122.5	185.4	-1724.5
				J	-783.4	-263.6	274.5	-122.5	3.4	-1271.1
			Min	I	-2721.9	-417.2	-35.5	-154.8	-75.5	-2949.8
				J	-2640.8	-452.2	-35.5	-154.8	-323.1	-2242.1
1000	2	102	INVSLE Max	I	0.3	0.0	5.7	2.4	-0.1	-0.1
				J	43.6	0.0	755.4	285.0	-11.2	0.1
			Min	I	0.2	-0.0	4.3	1.8	-0.1	-0.1
				J	-2.1	-0.0	40.1	-1208.4	-358.8	-12.4
			INVSLE Max	I	13.5	11.8	11.4	5.9	3.0	5.5
				J	15.5	11.8	47.3	2.5	-6.9	8.3
			Min	I	-13.0	-11.8	-2.9	-2.4	-3.1	-5.7
				J	-10.9	-11.8	33.0	-5.8	-15.4	-8.1
			INVSLE Max	I	0.2	0.0	4.3	1.8	-0.1	-0.1
				J	32.3	0.0	559.5	210.7	-11.2	0.1
			Min	I	0.2	-0.0	4.3	1.8	-0.1	-0.1
				J	-0.9	-0.0	40.1	-895.1	-265.8	-9.2
			INVSLEQP Max	I	0.2	0.0	4.3	1.8	-0.1	-0.1
				J	2.3	0.0	40.1	-1.7	-11.2	0.1
			Min	I	0.2	0.0	4.3	1.8	-0.1	-0.1
				J	2.3	0.0	40.1	-1.7	-11.2	0.1
			INVSLEF Max	I	0.2	0.0	4.3	1.8	-0.1	-0.1
				J	24.4	0.0	422.6	151.5	-11.2	0.1
			Min	I	0.2	0.0	4.3	1.8	-0.1	-0.1
				J	2.3	0.0	40.1	-658.3	-200.4	0.1
1001	2	102	INVSLE Max	I	496.7	862.9	-686.8	5352.3	233.0	943.9
				J	499.6	862.9	-640.0	5173.9	2480.3	513.1
			Min	I	69.5	241.4	-3813.4	-4188.9	-411.7	-1401.5
				J	73.1	241.4	-3685.9	-4203.0	278.8	-1621.4
			INVSLE Max	I	539.4	1386.6	-432.1	2115.2	320.6	1283.0
				J	542.1	1386.6	-385.8	2110.8	1122.9	407.6
			Min	I	-54.6	-294.1	-1463.0	-502.5	-161.2	-803.6
				J	-52.0	-294.1	-1416.6	-507.0	229.9	-632.9
			INVSLE Max	I	372.9	598.9	-882.1	3112.3	180.0	646.5
				J	375.7	598.9	-835.4	2979.0	1815.5	335.7
			Min	I	33.0	240.7	-2783.8	-2748.0	-297.1	-970.6
				J	41.5	240.7	-2689.3	-2758.4	409.8	-1171.6
			INVSLEQP Max	I	292.3	641.1	-847.0	1586.4	97.2	466.1
				J	295.0	641.1	-800.7	1581.9	629.0	52.5
			Min	I	247.5	632.4	-857.9	1496.3	75.6	253.6
				J	250.2	632.4	-811.5	1491.8	614.4	-154.3
			INVSLEF Max	I	267.7	443.5	-986.2	1452.6	100.1	202.2
				J	270.5	443.5	-939.8	1368.0	1384.0	-59.6
			Min	I	134.0	331.3	-2110.0	-1669.3	-165.6	-526.4
				J	142.5	331.3	-2036.5	-1685.7	541.1	-770.6
1002	2	102	INVSLE Max	I	489.8	871.8	-638.9	5196.4	2500.1	517.2
				J	493.0	871.8	-591.0	5025.2	4736.3	82.0
			Min	I	69.8	248.0	-3685.1	-4168.4	249.2	-1620.2
				J	73.4	248.0	-3556.1	-4194.9	730.1	-1850.3
			INVSLE Max	I	501.3	1386.2	-389.0	2116.0	1115.9	424.6
				J	504.0	1386.2	-342.5	2111.5	1998.6	-236.2
			Min	I	-27.8	-284.0	-1411.9	-489.7	197.1	-641.9

Sovrappasso di ingresso - Ponte strallato - Relazione di calcolo

			J	-25.1	-284.0	-1365.3	-494.2	452.1	-695.4		
		INVSLEP	Max	I	369.7	605.1	-834.8	2999.5	1824.7	337.6	
				J	372.7	605.1	-787.3	2871.5	3454.9	29.0	
			Min	I	38.4	245.9	-2688.7	-2733.2	402.3	-1169.9	
				J	52.4	245.9	-2593.2	-2752.8	1009.0	-1380.7	
		INVSLEQP	Max	I	285.2	645.9	-799.9	1592.1	597.0	58.0	
				J	287.8	645.9	-753.3	1587.7	1100.6	-360.6	
			Min	I	240.2	638.0	-810.7	1502.0	583.7	-149.0	
				J	242.9	638.0	-764.1	1497.5	1094.3	-562.5	
		INVSLEF	Max	I	265.4	448.2	-939.2	1385.8	1386.8	-57.6	
				J	268.5	448.2	-892.3	1304.6	2636.7	-317.4	
			Min	I	137.7	335.6	-2036.0	-1665.9	540.7	-768.8	
				J	151.8	335.6	-1961.5	-1689.0	1191.1	-1019.2	
1003	2	102	INVSLEP	Max	I	491.6	873.1	-590.9	5031.7	4739.9	82.5
				J	498.9	873.1	-548.9	4893.9	6605.1	-258.6	
			Min	I	72.9	249.0	-3556.0	-4185.0	725.5	-1850.5	
				J	75.9	249.0	-3447.6	-4224.3	1118.2	-2112.5	
		INVSLEP	Max	I	484.4	1378.1	-347.9	2111.4	2000.4	-241.3	
				J	486.7	1378.1	-307.9	2107.6	2739.9	-239.1	
			Min	I	-8.1	-274.5	-1359.7	-487.9	444.4	-689.2	
				J	-5.8	-274.5	-1319.7	-491.8	635.0	-1306.6	
		INVSLEP	Max	I	371.8	606.0	-787.2	2877.5	3456.6	29.2	
				J	377.9	606.0	-745.7	2774.5	4814.6	-195.5	
			Min	I	51.9	246.7	-2593.1	-2745.6	1007.5	-1380.7	
				J	54.1	246.7	-2512.7	-2774.8	1487.2	-1606.2	
		INVSLEQP	Max	I	286.3	646.6	-753.2	1590.5	1095.9	-359.9	
				J	288.6	646.6	-713.2	1586.6	1504.8	-720.4	
			Min	I	241.4	638.8	-764.0	1500.3	1089.7	-561.8	
				J	243.6	638.8	-724.0	1496.5	1504.7	-917.9	
		INVSLEF	Max	I	267.7	448.9	-892.2	1309.7	2637.3	-317.2	
				J	273.8	448.9	-851.6	1244.5	3670.4	-530.2	
			Min	I	151.0	336.2	-1961.5	-1683.4	1191.0	-1019.1	
				J	153.3	336.2	-1898.6	-1712.3	1722.1	-1240.4	
1004	2	103	INVSLEP	Max	I	487.0	883.1	-547.7	4964.7	6635.3	-256.8
				J	496.9	883.1	-517.6	4865.8	7932.5	-425.8	
			Min	I	71.9	256.6	-3446.6	-4113.5	1081.6	-2113.8	
				J	74.0	256.6	-3368.2	-4137.2	1340.3	-2377.3	
		INVSLEP	Max	I	450.1	1380.3	-313.0	2127.1	2728.9	-246.9	
				J	451.7	1380.3	-284.7	2124.3	3249.7	-151.6	
			Min	I	11.1	-265.8	-1312.8	-444.7	599.0	-1291.4	
				J	12.6	-265.8	-1284.6	-447.5	723.7	-1836.7	
		INVSLEP	Max	I	370.4	612.9	-745.0	2839.6	4830.4	-195.6	
				J	378.1	612.9	-715.4	2765.6	5774.7	-315.9	
			Min	I	50.0	252.7	-2512.0	-2694.2	1472.4	-1606.2	
				J	51.5	252.7	-2453.8	-2711.7	1802.1	-1820.0	
		INVSLEQP	Max	I	277.0	652.0	-712.2	1616.2	1468.6	-714.8	
				J	278.6	652.0	-683.9	1613.5	1755.0	-978.1	
			Min	I	231.9	645.1	-723.0	1526.3	1467.2	-912.5	
				J	233.5	645.1	-694.7	1523.5	1749.3	-1173.0	
		INVSLEF	Max	I	267.4	454.3	-850.9	1300.0	3676.7	-529.6	
				J	275.2	454.3	-822.1	1253.0	4395.2	-680.7	
			Min	I	147.1	341.1	-1898.0	-1649.0	1719.7	-1240.3	
				J	148.7	341.1	-1852.6	-1667.2	2082.2	-1406.9	
1005	2	103	INVSLEP	Max	I	497.1	883.1	-513.4	4867.6	7932.4	-425.9
				J	510.0	883.1	-483.0	4773.3	9203.4	-557.9	
			Min	I	74.3	256.6	-3362.4	-4134.8	1340.2	-2377.5	
				J	76.5	256.6	-3286.1	-4160.8	1563.3	-2672.5	
		INVSLEP	Max	I	441.9	1372.8	-286.8	2124.2	3252.0	-157.7	
				J	443.5	1372.8	-258.5	2121.4	3758.0	-58.3	
			Min	I	22.9	-258.3	-1274.1	-443.8	721.3	-1830.8	
				J	24.5	-258.3	-1245.8	-446.6	834.6	-2380.2	
		INVSLEP	Max	I	378.4	612.9	-711.2	2767.4	5774.7	-316.0	
				J	388.3	612.9	-681.3	2696.9	6699.5	-427.2	
			Min	I	51.8	252.7	-2449.6	-2709.9	1802.0	-1820.1	
				J	53.3	252.7	-2393.1	-2729.2	2105.1	-2043.2	
		INVSLEQP	Max	I	278.8	652.0	-679.7	1615.2	1754.9	-978.2	
				J	280.4	652.0	-651.4	1612.5	2028.2	-1241.5	
			Min	I	233.7	645.1	-690.5	1525.3	1749.2	-1173.1	
				J	235.3	645.1	-662.2	1522.5	2018.1	-1433.5	
		INVSLEF	Max	I	275.4	454.3	-817.9	1254.8	4395.2	-680.8	
				J	285.4	454.3	-789.0	1210.1	5098.2	-831.4	
			Min	I	148.9	341.1	-1848.3	-1665.4	2082.2	-1407.0	
				J	150.5	341.1	-1804.1	-1684.8	2418.2	-1573.9	
1006	2	102	INVSLEP	Max	I	497.7	892.5	-481.8	4867.4	9231.2	-560.6
				J	513.4	892.5	-419.7	4739.2	10926.2	-716.1	
			Min	I	72.4	263.9	-3285.2	-4008.7	1519.1	-2669.6	
				J	75.4	263.9	-3175.6	-4038.7	1784.1	-3134.7	
		INVSLEP	Max	I	411.2	1373.2	-265.5	2147.6	3746.1	-67.1	
				J	413.5	1373.2	-225.0	2143.7	4429.3	69.9	
			Min	I	37.4	-248.6	-1237.1	-384.6	799.8	-2365.3	

Sovrapasso di ingresso - Ponte strallato - Relazione di calcolo

			J	39.6	-248.6	-1196.6	-388.5	941.9	-3136.6		
		INVSLEP	Max	I	380.5	619.3	-680.7	2784.0	6713.8	-428.9	
				J	392.7	619.3	-624.2	2688.1	7946.1	-585.2	
		Min	I	49.2	258.4	-2392.3	-2618.6	2085.7	2085.7	-2043.8	
				J	51.4	258.4	-2311.1	-2640.9	2465.4	-2360.6	
		INVSLEQP	Max	I	269.0	657.0	-650.5	1651.3	1992.7	-1236.5	
				J	271.2	657.0	-610.0	1647.4	2354.5	-1607.1	
		Min	I	223.7	650.9	-661.2	1561.8	1981.2	1981.2	-1428.8	
				J	225.9	650.9	-620.7	1557.9	2336.9	-1795.9	
		INVSLEF	Max	I	278.7	459.3	-788.4	1284.5	5103.5	-831.6	
				J	290.9	459.3	-736.8	1223.7	6039.7	-1039.0	
		Min	I	144.4	345.7	-1803.4	-1598.1	2410.6	2410.6	-1575.0	
				J	146.6	345.7	-1739.6	-1621.6	2845.5	-1812.0	
1007	2	102	INVSLEP	Max	I	511.2	894.1	-419.5	4758.2	10931.1	-716.7
				J	525.2	894.1	-335.6	4619.8	12773.1	-893.7	
		Min	I	74.7	265.1	-3175.5	-4007.5	1775.7	1775.7	-3134.4	
				J	78.1	265.1	-3052.0	-4044.1	2048.8	-3664.1	
		INVSLEF	Max	I	400.2	1364.1	-236.0	2146.5	4429.6	61.4	
				J	402.7	1364.1	-190.0	2142.1	5171.1	212.0	
		Min	I	49.5	-237.8	-1185.4	-373.6	933.5	933.5	-3127.2	
				J	52.0	-237.8	-1139.4	-378.0	1073.5	-3999.1	
		INVSLEP	Max	I	391.3	620.4	-624.1	2705.7	7948.6	-585.6	
				J	402.3	620.4	-550.0	2602.1	9286.7	-763.1	
		Min	I	50.7	259.4	-2311.0	-2618.2	2461.5	2461.5	-2360.9	
				J	53.2	259.4	-2219.6	-2645.3	2860.7	-2721.8	
		INVSLEQP	Max	I	269.2	657.8	-609.8	1655.2	2348.3	-1606.3	
				J	271.7	657.8	-563.9	1650.8	2731.3	-2027.6	
		Min	I	224.0	651.9	-620.6	1565.8	2330.5	2330.5	-1795.1	
				J	226.4	651.9	-574.6	1561.4	2706.6	-2212.7	
		INVSLEF	Max	I	289.7	460.1	-736.7	1238.8	6040.7	-1039.2	
				J	300.8	460.1	-670.9	1173.1	7056.4	-1264.8	
		Min	I	145.6	346.5	-1739.4	-1603.8	2843.7	2843.7	-1812.3	
				J	148.1	346.5	-1667.3	-1631.6	3309.7	-2082.3	
1008	2	102	INVSLEP	Max	I	512.3	905.0	-334.1	4769.8	12805.2	-898.4
				J	522.4	905.0	-249.6	4636.6	14553.2	-1081.7	
		Min	I	71.2	273.4	-3050.9	-3794.5	1991.1	1991.1	-3664.9	
				J	73.7	273.4	-2926.8	-3825.9	2236.5	-4208.8	
		INVSLEF	Max	I	385.8	1360.7	-202.9	2184.4	5155.1	200.1	
				J	388.3	1360.7	-156.4	2180.0	5865.6	343.7	
		Min	I	46.0	-223.3	-1124.6	-279.9	1032.8	1032.8	-3981.5	
				J	48.5	-223.3	-1078.1	-284.4	1152.5	-4861.9	
		INVSLEP	Max	I	392.8	628.0	-549.1	2741.9	9303.1	-766.3	
				J	400.2	628.0	-474.5	2642.1	10571.2	-947.2	
		Min	I	48.2	265.9	-2218.7	-2464.1	2833.1	2833.1	-2726.1	
				J	50.7	265.9	-2126.7	-2487.3	3206.4	-3097.7	
		INVSLEQP	Max	I	258.2	663.2	-562.8	1712.0	2688.8	-2022.4	
				J	260.7	663.2	-516.3	1707.5	3045.4	-2452.0	
		Min	I	212.8	658.3	-573.5	1623.4	2662.5	2662.5	-2207.6	
				J	215.3	658.3	-526.9	1618.9	3012.2	-2634.1	
		INVSLEF	Max	I	292.6	466.0	-670.1	1292.8	7062.5	-1266.4	
				J	300.1	466.0	-604.1	1229.7	8024.2	-1497.3	
		Min	I	140.9	351.6	-1666.5	-1489.9	3296.9	3296.9	-2086.4	
				J	143.3	351.6	-1593.7	-1514.7	3737.7	-2364.6	
1009	2	102	INVSLEP	Max	I	962.4	858.3	-228.1	4753.6	14394.2	-1973.7
				J	968.1	858.3	-143.9	4619.6	16010.3	-2256.9	
		Min	I	204.5	269.6	-2893.9	-3732.0	2170.7	2170.7	-6015.4	
				J	207.2	269.6	-2774.5	-3762.4	2368.5	-6431.0	
		INVSLEF	Max	I	498.1	1332.8	-156.1	2199.7	5782.0	-160.2	
				J	500.8	1332.8	-110.1	2195.2	6425.7	-30.0	
		Min	I	102.7	-215.4	-1033.9	-231.7	1094.7	1094.7	-5105.6	
				J	105.4	-215.4	-987.9	-236.1	1184.6	-5951.9	
		INVSLEP	Max	I	711.0	592.8	-452.9	2697.1	10450.7	-1691.7	
				J	715.2	592.8	-378.5	2596.6	11621.3	-1871.7	
		Min	I	187.7	262.4	-2102.2	-2420.7	3144.0	3144.0	-4557.4	
				J	190.4	262.4	-2013.8	-2443.2	3468.7	-4895.0	
		INVSLEQP	Max	I	310.0	657.5	-493.8	1741.5	2969.4	-2692.4	
				J	312.7	657.5	-447.8	1737.0	3278.3	-3113.7	
		Min	I	266.8	648.7	-504.7	1653.9	2932.6	2932.6	-2865.1	
				J	269.5	648.7	-458.7	1649.5	3234.5	-3280.8	
		INVSLEF	Max	I	539.7	448.8	-582.8	1294.0	7932.8	-2143.2	
				J	543.1	448.8	-517.2	1230.3	8815.2	-2367.2	
		Min	I	267.8	340.1	-1568.8	-1465.0	3676.8	3676.8	-3554.9	
				J	270.5	340.1	-1498.4	-1489.2	4069.0	-3815.1	
1010	2	102	INVSLEP	Max	I	962.5	869.0	-142.6	4757.1	16027.8	-2257.5
				J	982.3	869.0	-57.0	4629.0	17543.4	-2517.4	
		Min	I	200.5	279.6	-2773.3	-3523.2	2323.3	2323.3	-6439.6	
				J	203.2	279.6	-2652.8	-3551.7	2491.8	-6872.2	
		INVSLEF	Max	I	507.9	1326.4	-125.6	2234.6	6411.1	-41.2	
				J	510.6	1326.4	-79.3	2230.1	7017.5	80.8	
		Min	I	81.0	-198.1	-970.9	-146.3	1153.1	1153.1	-5938.3	

Sovrapasso di ingresso - Ponte strallato - Relazione di calcolo

			J	83.7	-198.1	-924.6	-150.7	1224.2	-6787.6	
			INVSLE Max	I	710.1	601.7	-377.7	2726.2	11628.8	-1874.2
				J	724.8	601.7	-302.2	2630.2	12724.7	-2057.9
			Min	I	183.9	269.8	-2012.8	-2269.8	3446.7	-4900.5
				J	186.5	269.8	-1923.6	-2290.9	3743.1	-5250.9
			INVSLEQP Max	I	302.6	662.2	-446.9	1792.4	3244.7	-3110.6
				J	305.2	662.2	-400.6	1788.0	3525.1	-3537.6
			Min	I	259.2	654.1	-457.8	1705.8	3199.8	-3277.8
				J	261.8	654.1	-411.5	1701.3	3473.2	-3699.6
			INVSLEF Max	I	537.8	455.9	-516.4	1341.9	8816.3	-2369.5
				J	548.9	455.9	-450.2	1281.2	9641.1	-2597.9
			Min	I	264.1	346.2	-1497.6	-1353.9	4057.5	-3819.7
				J	266.8	346.2	-1426.4	-1376.9	4421.8	-4089.1
1011	2	102	INVSLE Max	I	979.0	874.6	-56.3	4707.5	17552.4	-2520.2
				J	1003.0	874.6	19.2	4597.7	18803.8	-2690.7
			Min	I	199.7	284.9	-2652.1	-3413.6	2467.8	-6877.2
				J	202.0	284.9	-2548.0	-3439.2	2590.6	-7262.6
			INVSLE Min	I	524.2	1317.2	-95.0	2252.1	7010.2	71.4
				J	526.6	1317.2	-54.4	2248.2	7507.3	170.8
			Min	I	60.8	-183.4	-908.0	-98.8	1206.4	-6777.2
				J	63.2	-183.4	-867.4	-102.7	1253.6	-7517.3
			INVSLE Max	I	721.8	606.3	-301.7	2704.5	12728.5	-2059.4
				J	739.6	606.3	-235.3	2622.1	13632.1	-2221.7
			Min	I	183.1	273.7	-1923.1	-2190.8	3731.3	-5254.1
				J	185.4	273.7	-1845.9	-2209.8	3966.3	-5565.8
			INVSLEQP Max	I	299.8	664.7	-400.2	1819.5	3507.1	-3536.0
				J	302.2	664.7	-359.6	1815.6	3728.1	-3911.7
			Min	I	256.3	656.9	-411.0	1733.3	3454.6	-3698.1
				J	258.7	656.9	-370.4	1729.4	3669.4	-4069.3
			INVSLEF Max	I	545.9	459.7	-449.7	1345.3	9641.5	-2599.2
				J	559.4	459.7	-391.6	1293.1	10320.4	-2801.0
			Min	I	263.4	349.4	-1425.9	-1298.9	4415.4	-4091.8
				J	265.7	349.4	-1364.2	-1319.3	4710.0	-4331.2
1012	2	103	INVSLE Max	I	994.6	886.8	20.7	4784.1	18820.2	-2697.1
				J	1010.8	886.8	73.4	4707.8	19654.0	-2822.0
			Min	I	192.0	296.5	-2546.5	-3107.8	2536.1	-7274.5
				J	193.6	296.5	-2473.9	-3123.9	2609.0	-7556.2
			INVSLE Min	I	535.3	1312.6	-66.9	2306.2	7485.2	161.2
				J	536.8	1312.6	-38.8	2303.5	7817.9	225.4
			Min	I	33.6	-166.7	-853.1	14.9	1217.5	-7505.4
				J	35.2	-166.7	-825.0	12.2	1242.7	-8029.2
			INVSLE Max	I	732.3	616.5	-234.2	2799.1	13637.9	-2225.3
				J	744.2	616.5	-187.9	2741.9	14238.9	-2343.2
			Min	I	177.5	282.2	-1844.8	-1969.8	3938.8	-5573.6
				J	179.1	282.2	-1791.0	-1981.6	4091.6	-5800.8
			INVSLEQP Max	I	289.9	669.9	-358.6	1890.0	3686.8	-3908.1
				J	291.5	669.9	-330.5	1887.2	3829.4	-4176.8
			Min	I	246.3	663.0	-369.4	1805.1	3626.8	-4066.0
				J	247.9	663.0	-341.3	1802.4	3765.1	-4331.9
			INVSLEF Max	I	552.1	467.9	-390.7	1446.2	10319.4	-2804.2
				J	561.2	467.9	-350.3	1410.0	10770.2	-2949.9
			Min	I	257.9	356.4	-1363.2	-1132.4	4694.6	-4337.7
				J	259.5	356.4	-1320.2	-1145.6	4889.6	-4512.3
1013	2	103	INVSLE Max	I	1011.1	886.8	77.7	4709.5	19653.9	-2822.1
				J	1025.3	886.8	131.2	4633.9	20459.2	-2946.8
			Min	I	193.8	296.5	-2468.1	-3121.4	2608.9	-7556.3
				J	195.4	296.5	-2396.0	-3138.5	2668.9	-7871.1
			INVSLE Min	I	552.2	1303.3	-47.1	2303.8	7819.8	219.6
				J	553.8	1303.3	-19.1	2301.0	8133.8	280.1
			Min	I	20.3	-157.4	-808.2	15.5	1240.7	-8023.5
				J	21.9	-157.4	-780.1	12.7	1258.6	-8543.6
			INVSLE Max	I	744.5	616.5	-183.7	2743.6	14238.8	-2343.3
				J	755.0	616.5	-136.8	2686.9	14818.6	-2461.2
			Min	I	179.3	282.2	-1786.7	-1979.9	4091.5	-5800.9
				J	179.4	282.2	-1733.3	-1992.5	4231.3	-6028.3
			INVSLEQP Max	I	291.7	669.9	-326.3	1889.0	3829.4	-4176.9
				J	293.3	669.9	-298.2	1886.2	3959.0	-4445.6
			Min	I	248.1	663.0	-337.1	1804.2	3765.0	-4332.0
				J	249.7	663.0	-309.0	1801.4	3890.3	-4597.9
			INVSLEF Max	I	561.4	467.9	-346.1	1411.8	10770.2	-2950.0
				J	569.4	467.9	-305.4	1375.7	11204.2	-3095.6
			Min	I	259.8	356.4	-1315.9	-1143.8	4889.5	-4512.4
				J	261.3	356.4	-1273.1	-1157.6	5071.5	-4687.0
1014	2	102	INVSLE Max	I	1022.2	891.3	131.8	4704.6	20462.7	-2949.2
				J	1038.0	891.3	207.4	4602.8	21520.4	-3124.8
			Min	I	191.0	300.6	-2395.4	-3010.5	2649.4	-7873.2
				J	193.3	300.6	-2294.4	-3033.7	2713.7	-8341.4
			INVSLE Min	I	568.6	1294.8	-32.2	2322.9	8126.6	272.8
				J	570.8	1294.8	7.9	2319.1	8536.6	350.2
			Min	I	-0.3	-144.7	-766.3	57.5	1244.6	-8535.6

Sovrapasso di ingresso - Ponte strallato - Relazione di calcolo

			J	1.9	-144.7	-726.2	53.7	1258.9	-9255.8	
			INVSLE Max	I	752.3	620.2	-136.4	2754.4	14819.1	-2462.6
				J	764.0	620.2	-69.9	2677.9	15579.3	-2628.1
			Min	I	176.3	285.2	-1732.8	-1899.8	4221.3	-6031.4
				J	174.9	285.2	-1658.0	-1917.0	4396.9	-6351.4
			INVSLEQP Max	I	288.9	671.7	-297.9	1914.3	3944.1	-4444.3
				J	291.2	671.7	-257.7	1910.4	4105.5	-4819.8
			Min	I	245.3	665.1	-308.6	1830.0	3875.0	-4596.8
				J	247.5	665.1	-268.5	1826.1	4030.3	-4968.5
			INVSLEF Max	I	566.7	470.9	-305.0	1434.2	11202.6	-3096.9
				J	575.7	470.9	-247.4	1385.7	11770.6	-3301.1
			Min	I	258.6	358.8	-1272.7	-1085.4	5065.7	-4689.6
				J	260.8	358.8	-1212.3	-1104.1	5300.2	-4935.4
1015	2	102	INVSLE Max	I	1031.2	901.2	208.6	4757.3	21527.9	-3130.1
				J	1044.0	901.2	297.2	4645.7	22662.0	-3339.1
			Min	I	184.1	309.1	-2293.2	-2753.5	2672.4	-8347.1
				J	186.6	309.1	-2176.1	-2779.5	2718.5	-8900.1
			INVSLEF Max	I	589.5	1284.3	-8.7	2370.0	8518.6	339.9
				J	592.1	1284.3	38.0	2365.5	8953.6	417.6
			Min	I	-32.5	-125.7	-708.1	148.6	1231.0	-9244.1
				J	-29.9	-125.7	-661.4	144.1	1232.2	-10075.3
			INVSLE Max	I	758.1	628.5	-69.1	2825.7	15580.3	-2631.1
				J	767.6	628.5	8.6	2741.9	16393.2	-2827.1
			Min	I	168.5	291.5	-1657.1	-1714.3	4375.4	-6358.8
				J	166.9	291.5	-1570.3	-1733.6	4551.0	-6738.2
			INVSLEQP Max	I	282.0	675.3	-257.0	1971.4	4073.8	-4817.3
				J	284.6	675.3	-210.3	1966.9	4232.9	-5256.5
			Min	I	238.2	669.3	-267.7	1888.3	3997.6	-4966.2
				J	240.8	669.3	-221.0	1883.8	4149.7	-5401.5
			INVSLEF Max	I	570.0	477.5	-246.7	1514.1	11767.4	-3303.8
				J	577.2	477.5	-179.5	1461.3	12373.1	-3544.3
			Min	I	254.9	363.9	-1211.6	-945.9	5287.4	-4941.5
				J	257.5	363.9	-1141.4	-966.9	5531.5	-5233.0
1016	2	102	INVSLE Max	I	1037.3	910.4	298.3	4794.8	22665.9	-3344.2
				J	1044.1	910.4	385.2	4687.1	23680.5	-3553.0
			Min	I	178.1	316.9	-2175.0	-2513.4	2679.7	-8905.3
				J	178.6	316.9	-2061.1	-2538.4	2694.8	-9454.2
			INVSLEF Max	I	613.6	1271.8	20.1	2417.2	8935.7	407.1
				J	616.0	1271.8	65.8	2412.9	9317.5	470.1
			Min	I	-66.1	-105.5	-642.3	233.3	1206.0	-10063.5
				J	-63.7	-105.5	-596.6	228.9	1191.6	-10869.4
			INVSLE Max	I	761.9	636.0	9.4	2885.3	16391.9	-2830.0
				J	766.9	636.0	85.7	2804.4	17116.9	-3024.9
			Min	I	160.9	297.2	-1569.5	-1541.4	4530.4	-6745.2
				J	159.2	297.2	-1485.1	-1559.9	4672.7	-7123.2
			INVSLEQP Max	I	275.9	678.6	-209.6	2025.3	4202.8	-5254.1
				J	278.4	678.6	-163.9	2020.9	4328.6	-5686.3
			Min	I	232.1	673.1	-220.3	1943.4	4118.6	-5399.2
				J	234.6	673.1	-174.6	1939.0	4237.7	-5828.0
			INVSLEF Max	I	571.7	483.6	-178.8	1586.2	12368.4	-3546.9
				J	575.6	483.6	-113.2	1535.1	12906.6	-3784.9
			Min	I	251.9	368.5	-1140.7	-815.0	5518.9	-5238.7
				J	254.4	368.5	-1072.2	-835.1	5728.2	-5529.2
1017	2	102	INVSLE Max	I	1168.1	897.4	135.3	3800.3	23639.2	-2159.0
				J	1179.6	897.4	225.1	3686.5	24581.6	-2467.4
			Min	I	-535.8	332.7	-2083.1	-2402.8	2953.8	-9514.5
				J	-533.1	332.7	-1968.8	-2423.5	3131.9	-9929.2
			INVSLEF Max	I	344.7	1279.4	-171.0	1202.5	9470.1	2016.6
				J	347.4	1279.4	-124.4	1198.0	9926.2	2038.2
			Min	I	-717.0	-56.5	-752.7	-293.6	1367.7	-8466.3
				J	-714.3	-56.5	-706.1	-298.1	1481.0	-9281.4
			INVSLE Max	I	750.6	617.4	-70.7	2258.9	17126.6	-1945.0
				J	759.1	617.4	7.9	2173.5	17826.9	-2190.4
			Min	I	-275.6	316.2	-1546.3	-1669.7	4847.9	-6915.7
				J	-272.9	316.2	-1461.7	-1685.0	5086.8	-7259.9
			INVSLEQP Max	I	-456.8	734.0	-486.3	575.2	4604.0	-2461.8
				J	-454.1	734.0	-439.7	570.7	4908.0	-2938.1
			Min	I	-515.3	724.3	-491.6	520.6	4517.0	-2667.1
				J	-512.6	724.3	-445.0	516.1	4817.6	-3137.1
			INVSLEF Max	I	440.1	485.6	-236.7	1087.6	12964.2	-2686.2
				J	446.6	485.6	-169.3	1033.9	13508.0	-2977.6
			Min	I	-89.0	377.1	-1157.7	-1110.6	5864.5	-5115.9
				J	-86.3	377.1	-1088.7	-1128.3	6145.0	-5400.4
1018	2	102	INVSLE Max	I	1176.9	896.6	225.4	3762.1	24578.1	-2467.9
				J	1202.5	896.6	315.6	3653.4	25424.0	-2774.4
			Min	I	-538.1	335.8	-1968.3	-2287.1	3121.8	-9936.0
				J	-535.4	335.8	-1854.8	-2309.6	3268.9	-10353.3
			INVSLEF Max	I	370.1	1261.4	-144.2	1228.1	9923.1	2028.9
				J	372.8	1261.4	-97.8	1223.6	10331.3	2040.4
			Min	I	-744.0	-40.4	-686.0	-256.1	1473.6	-9272.4

Sovrapasso di ingresso - Ponte strallato - Relazione di calcolo

			J	-741.4	-40.4	-639.7	-260.6	1571.9	-10072.4	
			INVSLE Max	I	756.7	617.9	8.1	2246.3	17823.6	-2191.7
				J	775.6	617.9	87.0	2164.5	18452.3	-2432.9
			Min	I	-276.1	317.8	-1461.3	-1586.3	5082.3	-7264.7
				J	-273.4	317.8	-1377.3	-1603.0	5290.0	-7610.2
			INVSLEQP Max	I	-458.4	731.0	-439.6	601.1	4902.4	-2937.6
				J	-455.7	731.0	-393.3	596.7	5175.0	-3409.7
			Min	I	-516.9	721.7	-444.9	547.1	4811.8	-3136.7
				J	-514.3	721.7	-398.6	542.7	5080.8	-3602.7
			INVSLEF Max	I	444.1	485.9	-169.0	1097.4	13505.2	-2978.7
				J	458.5	485.9	-101.8	1046.1	13993.6	-3265.3
			Min	I	-89.0	378.0	-1088.4	-1049.8	6142.8	-5404.0
				J	-86.3	378.0	-1019.6	-1049.5	6391.8	-5689.2
1019	2	102	INVSLE Max	I	1197.6	896.1	316.1	3784.7	25421.7	-2775.3
				J	1221.5	896.1	394.6	3691.1	26076.7	-3040.2
			Min	I	-543.7	340.8	-1853.9	-2073.6	3251.8	-10365.0
				J	-541.4	340.8	-1757.0	-2048.1	3355.0	-10733.1
			INVSLE Min	I	393.5	1241.8	-116.3	1278.7	10323.3	2030.7
				J	395.8	1241.8	-76.1	1274.9	10639.8	2031.7
			Min	I	-774.0	-24.1	-620.7	-190.4	1561.5	-10063.6
				J	-771.7	-24.1	-580.5	-194.2	1635.3	-10746.2
			INVSLE Max	I	771.3	619.2	87.4	2290.8	18449.5	-2435.2
				J	789.0	619.2	156.0	2220.4	18936.6	-2642.8
			Min	I	-278.8	320.5	-1376.6	-1432.0	5282.2	-7618.4
				J	-276.5	320.5	-1304.8	-1426.0	5437.9	-7922.1
			INVSLEQP Max	I	-462.8	726.0	-393.2	650.2	5165.2	-3409.0
				J	-460.5	726.0	-353.0	646.3	5377.1	-3815.4
			Min	I	-521.4	717.2	-398.4	597.3	5070.7	-3602.2
				J	-519.1	717.2	-358.2	593.4	5279.6	-4003.7
			INVSLEF Max	I	454.2	486.9	-101.3	1155.9	13990.9	-3267.3
				J	467.6	486.9	-43.0	1111.6	14369.5	-3513.6
			Min	I	-90.9	379.6	-1019.1	-917.3	6387.7	-5695.3
				J	-88.6	379.6	-960.1	-948.6	6579.2	-5945.3
1020	2	103	INVSLE Max	I	1212.4	898.8	395.6	3928.9	26067.1	-3041.9
				J	1226.6	898.8	451.3	3862.2	26487.9	-3231.2
			Min	I	-555.8	349.6	-1755.4	-1648.2	3324.2	-10753.7
				J	-554.2	349.6	-1687.1	-1686.4	3384.5	-11026.3
			INVSLE Min	I	410.8	1220.3	-90.4	1381.9	10620.8	2022.0
				J	412.4	1220.3	-62.3	1379.2	10826.9	2016.8
			Min	I	-807.7	-8.9	-565.4	-74.5	1619.2	-10738.0
				J	-806.1	-8.9	-537.2	-77.3	1665.7	-11220.2
			INVSLE Max	I	781.2	624.2	156.7	2448.8	18927.6	-2646.8
				J	791.7	624.2	205.3	2398.6	19240.7	-2795.7
			Min	I	-285.8	325.0	-1303.7	-1169.8	5423.0	-7936.4
				J	-284.2	325.0	-1253.1	-1191.0	5521.0	-8159.9
			INVSLEQP Max	I	-472.8	717.0	-352.8	744.0	5358.7	-3814.3
				J	-471.2	717.0	-324.6	741.2	5497.2	-4102.7
			Min	I	-531.6	709.3	-358.0	692.9	5260.5	-4002.8
				J	-530.0	709.3	-329.9	690.2	5396.9	-4288.2
			INVSLEF Max	I	459.8	490.6	-42.3	1310.0	14361.7	-3517.1
				J	467.8	490.6	-1.1	1278.4	14605.4	-3693.2
			Min	I	-96.5	382.1	-959.3	-710.8	6570.4	-5956.1
				J	-94.9	382.1	-917.7	-732.0	6694.1	-6139.4
1021	2	103	INVSLE Max	I	1226.9	898.8	455.6	3863.9	26487.8	-3231.3
				J	1239.0	898.8	511.8	3797.7	26929.3	-3420.7
			Min	I	-554.0	349.6	-1681.3	-1684.0	3384.4	-11026.4
				J	-552.4	349.6	-1613.5	-1723.9	3431.7	-11299.2
			INVSLE Min	I	429.6	1209.1	-71.4	1383.4	10828.6	2011.2
				J	431.2	1209.1	-43.3	1380.6	11014.4	2001.2
			Min	I	-822.8	2.3	-519.6	-78.0	1663.9	-11214.8
				J	-821.2	2.3	-491.4	-80.7	1704.7	-11692.1
			INVSLE Max	I	791.9	624.2	209.6	2400.4	19240.6	-2795.8
				J	800.9	624.2	258.6	2350.6	19569.0	-2944.2
			Min	I	-284.0	325.0	-1248.9	-1189.2	5521.0	-8160.0
				J	-282.4	325.0	-1198.6	-1211.2	5606.0	-8383.6
			INVSLEQP Max	I	-471.0	717.0	-320.4	743.0	5497.1	-4102.8
				J	-469.4	717.0	-292.2	740.2	5622.5	-4391.3
			Min	I	-529.8	709.3	-325.6	692.0	5396.8	-4288.3
				J	-528.2	709.3	-297.5	689.2	5520.1	-4573.6
			INVSLEF Max	I	468.0	490.6	3.1	1280.2	14605.4	-3693.3
				J	474.8	490.6	44.4	1248.7	14831.8	-3868.7
			Min	I	-94.7	382.1	-913.5	-730.2	6694.1	-6139.5
				J	-93.1	382.1	-872.1	-752.2	6804.8	-6322.7
1022	2	102	INVSLE Max	I	1235.2	899.8	512.2	3897.5	26914.3	-3421.4
				J	1248.4	899.8	591.8	3806.9	27435.2	-3685.2
			Min	I	-558.2	353.1	-1612.8	-1556.8	3418.9	-11307.6
				J	-555.9	353.1	-1517.6	-1612.9	3465.5	-11693.3
			INVSLE Min	I	448.1	1193.0	-56.8	1431.1	11006.8	1993.9
				J	450.3	1193.0	-16.5	1427.3	11236.4	1972.0
			Min	I	-846.6	15.9	-477.6	-35.7	1697.0	-11685.5

Sovrapasso di ingresso - Ponte strallato - Relazione di calcolo

			J	-844.4	15.9	-437.2	-39.6	1745.1	-12342.7	
			INVSLE Max	I	797.6	626.2	258.9	2446.4	19557.2	-2945.9
				J	807.4	626.2	328.3	2378.3	19944.9	-3152.4
			Min	I	-286.2	326.8	-1198.1	-1103.9	5599.5	-8389.5
				J	-283.9	326.8	-1127.6	-1134.5	5698.9	-8704.9
			INVSLEQP Max	I	-474.3	713.3	-292.2	781.7	5614.6	-4390.9
				J	-472.1	713.3	-251.8	777.9	5770.4	-4791.6
			Min	I	-533.2	706.0	-297.4	731.5	5511.9	-4573.4
				J	-530.9	706.0	-257.0	727.7	5664.8	-4970.0
			INVSLEF Max	I	471.6	492.1	44.7	1331.9	14826.7	-3870.2
				J	479.0	492.1	103.4	1288.8	15126.3	-4114.1
			Min	I	-96.3	383.1	-871.8	-652.8	6800.7	-6327.2
				J	-94.1	383.1	-813.4	-683.4	6935.9	-6585.2
1023	2	102	INVSLE Max	I	1240.3	903.1	592.6	4014.5	27403.1	-3686.6
				J	1250.1	903.1	684.8	3914.4	27916.1	-3989.0
			Min	I	-567.5	360.1	-1516.3	-1273.7	3439.2	-11710.7
				J	-565.0	360.1	-1406.9	-1350.0	3464.8	-12168.3
			INVSLE Min	I	471.0	1168.7	-32.4	1535.0	11218.1	1961.7
				J	473.6	1168.7	14.1	1530.5	11438.6	1923.8
			Min	I	-882.1	34.7	-420.7	48.5	1730.8	-12333.8
				J	-879.5	34.7	-374.2	44.1	1773.5	-13074.5
			INVSLE Max	I	800.5	631.1	329.0	2576.9	19919.7	-3155.8
				J	807.8	631.1	409.3	2501.6	20302.0	-3392.4
			Min	I	-291.5	330.3	-1126.7	-915.3	5685.1	-8717.1
				J	-288.9	330.3	-1045.6	-955.8	5771.3	-9089.1
			INVSLEQP Max	I	-482.0	705.8	-251.7	863.6	5753.6	-4790.9
				J	-479.5	705.8	-205.3	859.1	5904.8	-5247.5
			Min	I	-541.0	699.4	-256.9	815.1	5647.4	-4969.5
				J	-538.4	699.4	-210.4	810.6	5795.3	-5422.0
			INVSLEF Max	I	472.4	495.6	104.0	1460.3	15111.1	-4117.1
				J	478.0	495.6	171.5	1412.9	15397.4	-4384.7
			Min	I	-100.5	385.1	-812.7	-480.7	6926.8	-6594.4
				J	-98.0	385.1	-745.4	-521.1	7054.2	-6897.0
1024	2	102	INVSLE Max	I	1242.7	907.3	685.5	4128.3	27884.0	-3990.2
				J	1248.0	907.3	776.8	4030.9	28307.4	-4288.7
			Min	I	-575.2	366.2	-1405.7	-1093.7	3440.8	-12183.0
				J	-572.7	366.2	-1298.7	-1169.3	3436.3	-12648.8
			INVSLE Min	I	496.1	1143.7	-0.6	1636.2	11420.7	1913.6
				J	498.6	1143.7	45.5	1631.7	11592.8	1862.4
			Min	I	-917.2	54.6	-359.1	115.8	1760.2	-13065.4
				J	-914.7	54.6	-313.0	111.4	1789.4	-13782.7
			INVSLE Max	I	801.5	636.5	409.8	2700.7	20276.9	-3395.4
				J	805.5	636.5	489.4	2627.4	20592.8	-3628.8
			Min	I	-295.6	333.3	-1044.8	-783.3	5758.1	-9099.5
				J	-293.1	333.3	-965.5	-823.6	5813.8	-9476.5
			INVSLEQP Max	I	-488.2	699.0	-205.2	937.3	5888.9	-5246.9
				J	-485.7	699.0	-159.1	932.8	6009.0	-5695.1
			Min	I	-547.2	693.3	-210.3	890.3	5778.9	-5421.5
				J	-544.7	693.3	-164.2	885.8	5895.8	-5866.1
			INVSLEF Max	I	472.0	499.6	172.1	1581.7	15380.0	-4388.3
				J	475.1	499.6	238.9	1535.6	15618.6	-4639.9
			Min	I	-103.8	386.7	-744.8	-364.0	7045.0	-6904.8
				J	-101.3	386.7	-678.7	-404.2	7141.5	-7209.6
1025	2	102	INVSLE Max	I	1082.4	830.2	555.3	3338.3	28284.8	-3004.7
				J	1103.8	830.2	646.5	3233.9	28657.7	-3320.1
			Min	I	-1147.4	345.9	-1364.3	-1232.1	3649.4	-11927.7
				J	-1144.7	345.9	-1258.7	-1302.1	3755.2	-12319.2
			INVSLE Min	I	353.3	1093.7	-117.8	742.0	11739.1	2861.8
				J	356.0	1093.7	-71.7	737.5	11957.5	2793.0
			Min	I	-1465.6	63.9	-427.2	-226.2	1899.7	-11806.7
				J	-1462.9	63.9	-381.0	-230.6	2002.1	-12481.8
			INVSLE Max	I	633.3	575.9	352.5	2217.4	20597.1	-2697.8
				J	649.1	575.9	432.1	2138.9	20889.9	-2940.4
			Min	I	-660.6	317.3	-1036.4	-969.1	5957.6	-8756.3
				J	-657.9	317.3	-958.1	-1006.5	6069.9	-9079.9
			INVSLEQP Max	I	-928.6	680.3	-350.9	71.5	6184.0	-3750.3
				J	-925.9	680.3	-304.7	67.1	6395.3	-4187.6
			Min	I	-998.8	671.1	-351.5	47.5	6074.6	-3969.8
				J	-996.1	671.1	-305.4	43.0	6285.5	-4401.2
			INVSLEF Max	I	274.9	461.7	137.8	1236.2	15661.9	-3645.9
				J	286.9	461.7	204.6	1186.5	15893.2	-3918.0
			Min	I	-366.8	361.7	-752.0	-620.0	7247.7	-6559.4
				J	-364.1	361.7	-686.6	-657.4	7380.4	-6833.2
1026	2	102	INVSLE Max	I	1095.7	823.8	646.9	3559.8	28598.5	-3322.9
				J	1122.5	823.8	738.5	3457.9	28873.0	-3632.5
			Min	I	-1157.6	353.1	-1257.3	-943.2	3738.6	-12340.9
				J	-1154.9	353.1	-1151.3	-1011.9	3814.8	-12741.4
			INVSLE Min	I	377.9	1056.5	-79.3	906.8	11940.0	2781.3
				J	380.5	1056.5	-33.2	902.3	12111.2	2700.2
			Min	I	-1504.2	82.2	-373.3	-148.9	1995.1	-12474.7

Sovrapasso di ingresso - Ponte strallato - Relazione di calcolo

			J	-1501.6	82.2	-327.3	-153.3	2084.9	-13124.0	
			INVSLEP Max	I	642.1	574.5	432.5	2437.1	20846.2	-2945.1
				J	662.0	574.5	512.2	2360.4	21066.2	-3183.1
			Min	I	-666.7	319.7	-957.2	-763.6	6061.5	-9095.3
				J	-664.1	319.7	-878.6	-800.3	6132.2	-9423.9
			INVSLEQP Max	I	-937.0	663.3	-305.0	179.9	6386.5	-4188.5
				J	-934.4	663.3	-259.0	175.5	6567.8	-4614.0
			Min	I	-1007.4	655.3	-305.6	158.0	6276.4	-4402.3
				J	-1004.7	655.3	-259.6	153.6	6457.4	-4822.7
			INVSLEF Max	I	279.8	461.2	205.1	1438.3	15863.7	-3922.4
				J	294.8	461.2	271.8	1390.0	16038.8	-4188.4
			Min	I	-371.5	361.4	-686.0	-436.8	7373.9	-6844.9
				J	-368.9	361.4	-620.2	-473.6	7476.6	-7121.5
1027	2	102	INVSLEP Max	I	1122.1	823.5	738.5	3472.9	28870.8	-3632.6
				J	1143.6	823.5	823.7	3383.3	29054.5	-3905.4
			Min	I	-1155.5	353.4	-1151.2	-995.3	3814.0	-12742.4
				J	-1153.2	353.4	-1059.3	-1063.3	3856.6	-13096.1
			INVSLEF Max	I	403.2	1040.3	-37.0	918.8	12112.4	2693.2
				J	405.6	1040.3	3.6	914.9	12224.4	2611.4
			Min	I	-1525.2	97.5	-323.5	-158.1	2082.4	-13117.1
				J	-1522.8	97.5	-282.8	-162.0	2151.5	-13679.1
			INVSLEP Max	I	661.6	574.4	512.3	2374.1	21064.5	-3183.3
				J	677.6	574.4	583.1	2306.8	21215.2	-3391.7
			Min	I	-664.5	319.9	-878.6	-789.0	6131.6	-9424.6
				J	-662.1	319.9	-810.5	-825.2	6161.3	-9714.6
			INVSLEQP Max	I	-934.9	662.5	-259.0	180.8	6567.4	-4614.1
				J	-932.6	662.5	-218.4	176.9	6702.8	-4988.9
			Min	I	-1005.2	654.6	-259.6	159.0	6457.0	-4822.7
				J	-1002.9	654.6	-219.0	155.1	6592.1	-5193.1
			INVSLEF Max	I	294.5	461.1	271.8	1401.6	16037.7	-4188.6
				J	306.6	461.1	330.9	1358.8	16158.5	-4421.6
			Min	I	-369.2	361.4	-620.2	-463.3	7476.2	-7122.1
				J	-366.9	361.4	-562.9	-499.4	7542.3	-7366.2
1028	2	103	INVSLEP Max	I	1129.4	817.6	824.9	3908.9	28969.9	-3909.8
				J	1141.1	817.6	891.1	3843.6	29042.1	-4098.0
			Min	I	-1172.7	364.4	-1057.1	-495.7	3827.9	-13129.6
				J	-1171.2	364.4	-993.6	-540.6	3844.7	-13389.8
			INVSLEF Max	I	419.5	995.0	2.0	1211.2	12187.1	2599.7
				J	421.0	995.0	30.1	1208.4	12244.6	2535.0
			Min	I	-1566.9	112.4	-281.3	-48.9	2141.6	-13674.3
				J	-1565.4	112.4	-253.2	-51.7	2184.9	-14053.7
			INVSLEP Max	I	665.6	575.3	583.8	2792.8	21153.0	-3399.1
				J	674.2	575.3	632.9	2743.7	21216.9	-3544.4
			Min	I	-675.7	323.4	-809.1	-438.2	6138.8	-9738.4
				J	-674.1	323.4	-762.0	-462.3	6146.0	-9949.4
			INVSLEQP Max	I	-949.7	635.3	-218.9	364.6	6684.8	-4990.6
				J	-948.2	635.3	-190.9	361.9	6767.2	-5245.3
			Min	I	-1020.3	629.3	-219.4	346.1	6573.8	-5195.1
				J	-1018.7	629.3	-191.4	343.4	6656.0	-5447.4
			INVSLEF Max	I	294.7	462.6	331.7	1765.0	16116.0	-4428.5
				J	301.3	462.6	372.4	1734.0	16168.8	-4589.8
			Min	I	-378.4	360.7	-561.9	-143.8	7527.7	-7384.3
				J	-376.8	360.7	-522.3	-167.9	7560.7	-7560.5
1029	2	103	INVSLEP Max	I	1141.5	817.6	896.8	3845.4	29042.0	-4098.1
				J	1152.1	817.6	964.1	3780.0	29092.1	-4286.3
			Min	I	-1170.9	364.4	-987.9	-538.2	3844.6	-13389.9
				J	-1169.4	364.4	-932.1	-585.0	3848.4	-13650.1
			INVSLEF Max	I	438.3	990.6	34.6	1218.1	12246.2	2530.0
				J	439.9	990.6	62.7	1215.3	12282.9	2459.5
			Min	I	-1582.2	116.8	-249.3	-57.7	2183.2	-14048.8
				J	-1580.6	116.8	-221.2	-60.5	2221.4	-14422.3
			INVSLEP Max	I	674.5	575.3	637.1	2745.5	21216.8	-3544.5
				J	682.3	575.3	686.9	2696.4	21264.4	-3689.2
			Min	I	-673.9	323.4	-757.8	-460.5	6145.9	-9949.5
				J	-672.3	323.4	-710.7	-485.4	6140.2	-10160.5
			INVSLEQP Max	I	-947.9	635.3	-186.6	363.6	6767.1	-5245.4
				J	-946.3	635.3	-158.6	360.9	6836.6	-5500.1
			Min	I	-1018.5	629.3	-187.1	345.2	6655.9	-5447.5
				J	-1016.9	629.3	-159.1	342.4	6725.2	-5699.8
			INVSLEF Max	I	301.5	462.6	376.7	1735.8	16168.7	-4589.9
				J	307.5	462.6	417.9	1704.6	16208.2	-4750.7
			Min	I	-376.6	360.7	-518.1	-166.2	7560.7	-7560.6
				J	-375.0	360.7	-478.4	-191.1	7580.7	-7736.8
1030	2	102	INVSLEP Max	I	1153.7	818.0	964.0	3721.6	29104.1	-4285.9
				J	1164.8	818.0	1060.6	3633.3	29132.0	-4553.7
			Min	I	-1167.2	363.3	-932.3	-647.5	3851.7	-13646.5
				J	-1165.0	363.3	-856.5	-717.1	3837.4	-14014.3
			INVSLEF Max	I	458.6	990.6	64.6	1190.2	12289.3	2454.9
				J	460.9	990.6	105.5	1186.3	12310.0	2346.5
			Min	I	-1596.0	120.2	-223.2	-81.3	2220.6	-14416.9

Sovrapasso di ingresso - Ponte strallato - Relazione di calcolo

			J	-1593.7	120.2	-182.3	-85.2	2267.0	-14940.4	
			INVSLE Max	I	683.7	575.1	686.9	2642.3	21273.2	-3688.4
				J	691.9	575.1	758.4	2575.8	21308.7	-3893.7
			Min	I	-670.9	323.0	-710.8	-528.4	6142.9	-10157.9
				J	-668.6	323.0	-644.2	-566.1	6115.1	-10456.5
			INVSLEQP Max	I	-944.5	638.3	-158.5	339.6	6838.8	-5499.9
				J	-942.2	638.3	-117.7	335.7	6917.7	-5863.1
			Min	I	-1015.0	632.1	-159.0	320.8	6727.4	-5699.6
				J	-1012.7	632.1	-118.2	316.8	6806.0	-6059.2
			INVSLEF Max	I	308.8	462.3	417.8	1659.4	16214.4	-4750.0
				J	315.1	462.3	477.1	1617.0	16245.5	-4978.2
			Min	I	-373.7	360.8	-478.5	-230.5	7582.6	-7734.9
				J	-371.5	360.8	-421.9	-267.2	7591.4	-7984.4
1031	2	102	INVSLE Max	I	1153.3	815.1	1061.6	4032.9	29062.8	-4556.9
				J	1161.2	815.1	1170.8	3932.4	28992.4	-4852.4
			Min	I	-1179.2	371.2	-855.7	-294.0	3814.3	-14038.8
				J	-1176.7	371.2	-770.1	-371.7	3770.7	-14464.6
			INVSLEF Max	I	480.3	955.3	118.6	1428.2	12278.0	2335.6
				J	482.8	955.3	164.6	1423.8	12256.8	2199.4
			Min	I	-1635.4	132.2	-195.6	-14.8	2257.9	-14934.5
				J	-1632.9	132.2	-149.5	-19.2	2298.9	-15495.6
			INVSLE Max	I	682.4	576.9	759.0	2942.4	21257.7	-3899.0
				J	688.2	576.9	840.0	2868.0	21222.3	-4127.3
			Min	I	-678.6	324.0	-643.1	-273.3	6096.0	-10474.0
				J	-676.0	324.0	-567.7	-315.1	6036.8	-10816.9
			INVSLEQP Max	I	-954.7	617.7	-118.2	481.6	6901.4	-5864.5
				J	-952.2	617.7	-72.1	477.1	6962.7	-6260.5
			Min	I	-1025.4	612.9	-118.6	465.2	6789.5	-6060.8
				J	-1022.8	612.9	-72.6	460.8	6850.6	-6453.8
			INVSLEF Max	I	305.9	464.3	477.7	1923.6	16209.7	-4983.2
				J	310.4	464.3	544.6	1876.4	16186.8	-5235.7
			Min	I	-380.0	360.1	-421.1	-0.3	7577.7	-7997.8
				J	-377.5	360.1	-357.0	-41.5	7559.7	-8282.8
1032	2	102	INVSLE Max	I	1150.9	812.7	1171.7	4361.7	28926.3	-4854.9
				J	1156.2	812.7	1280.5	4259.4	28770.6	-5144.7
			Min	I	-1188.6	372.8	-769.4	-13.3	3749.7	-14484.2
				J	-1186.1	372.8	-684.7	-89.2	3676.9	-14919.3
			INVSLEF Max	I	503.8	923.9	184.5	1638.9	12226.0	2189.3
				J	506.3	923.9	230.5	1634.5	12157.9	2038.3
			Min	I	-1672.7	143.4	-169.6	33.0	2290.1	-15489.3
				J	-1670.2	143.4	-123.6	28.5	2319.0	-16021.9
			INVSLE Max	I	679.7	579.2	840.4	3181.9	21173.7	-4131.6
				J	683.7	579.2	921.1	3106.2	21075.2	-4357.2
			Min	I	-684.4	322.9	-566.8	-65.5	6018.6	-10830.9
				J	-681.9	322.9	-492.2	-109.5	5930.0	-11178.9
			INVSLEQP Max	I	-962.7	599.8	-72.6	603.0	6946.6	-6261.6
				J	-960.2	599.8	-26.6	598.6	6978.6	-6645.8
			Min	I	-1033.4	596.3	-73.0	588.8	6834.3	-6455.0
				J	-1030.9	596.3	-27.0	584.4	6866.1	-6837.0
			INVSLEF Max	I	302.3	466.0	545.1	2138.5	16152.1	-5239.7
				J	305.4	466.0	611.5	2090.4	16080.4	-5488.0
			Min	I	-384.8	359.2	-356.4	185.7	7545.7	-8293.5
				J	-382.3	359.2	-292.7	145.5	7498.2	-8581.3
1033	2	102	INVSLE Max	I	739.0	683.5	1113.0	3699.9	28854.5	-4223.5
				J	760.4	683.5	1221.7	3594.9	28703.8	-4520.4
			Min	I	-1580.2	303.4	-839.3	-654.8	3839.1	-12985.4
				J	-1577.5	303.4	-754.8	-728.8	3821.9	-13329.0
			INVSLEF Max	I	467.1	859.9	127.5	959.4	12298.4	2615.0
				J	469.8	859.9	173.9	955.0	12256.4	2452.0
			Min	I	-2134.0	128.0	-180.2	-106.0	2365.2	-14418.6
				J	-2131.3	128.0	-133.8	-110.5	2411.3	-14892.8
			INVSLE Max	I	376.5	506.7	799.7	2696.9	21137.8	-3644.5
				J	392.4	506.7	880.2	2619.1	21041.8	-3864.0
			Min	I	-950.3	273.6	-573.0	-405.5	6023.0	-9778.6
				J	-947.6	273.6	-498.4	-461.4	5941.7	-10060.5
			INVSLEQP Max	I	-1148.1	564.0	-75.4	307.5	7048.2	-5802.0
				J	-1145.4	564.0	-29.0	303.0	7081.9	-6165.8
			Min	I	-1226.4	557.3	-78.5	303.8	6939.2	-6026.3
				J	-1223.7	557.3	-32.2	299.3	6974.9	-6385.8
			INVSLEF Max	I	47.5	402.6	532.0	1798.8	16144.9	-4701.1
				J	59.5	402.6	598.7	1748.8	16070.3	-4931.9
			Min	I	-580.4	315.5	-355.0	-84.1	7573.1	-7587.5
				J	-577.7	315.5	-291.5	-123.7	7527.8	-7833.5
1034	2	102	INVSLE Max	I	755.6	675.3	1221.9	3862.1	28664.4	-4522.4
				J	782.4	675.3	1331.6	3758.9	28422.7	-4815.4
			Min	I	-1583.7	302.4	-754.7	-586.5	3815.3	-13341.6
				J	-1581.1	302.4	-670.0	-663.1	3768.3	-13689.0
			INVSLEF Max	I	492.4	835.5	194.9	1092.6	12243.1	2443.0
				J	495.1	835.5	241.4	1088.1	12152.5	2265.2
			Min	I	-2164.1	134.9	-155.3	-86.8	2407.2	-14887.5

Sovrapasso di ingresso - Ponte strallato - Relazione di calcolo

			J	-2161.4	134.9	-108.8	-91.3	2442.0	-15337.5	
			INVSLE Max	I	388.4	503.0	880.3	2815.2	21012.8	-3867.0
				J	408.3	503.0	961.6	2738.8	20849.5	-4084.0
			Min	I	-952.2	271.1	-498.1	-319.1	5933.5	-10069.6
				J	-949.6	271.1	-423.4	-377.0	5822.0	-10353.4
			INVSLEQP Max	I	-1151.1	551.2	-29.4	381.1	7074.0	-6167.1
				J	-1148.4	551.2	17.1	376.6	7077.9	-6523.8
			Min	I	-1229.5	545.3	-32.6	376.1	6967.2	-6387.2
				J	-1226.8	545.3	13.9	371.7	6973.2	-6740.1
			INVSLEF Max	I	55.4	400.4	598.8	1908.6	16049.4	-4934.7
				J	70.5	400.4	666.0	1859.5	15922.8	-5161.9
			Min	I	-581.6	313.7	-291.3	5.0	7521.2	-7840.4
				J	-578.9	313.7	-227.4	-36.0	7445.8	-8087.4
1035	2	102	INVSLE Max	I	777.0	667.5	1331.9	4045.1	28390.6	-4817.4
				J	797.7	667.5	1427.4	3954.2	28108.3	-5067.6
			Min	I	-1587.6	301.2	-669.9	-511.5	3760.7	-13702.2
				J	-1585.3	301.2	-597.4	-582.2	3695.7	-14006.6
			INVSLE Min	I	515.8	810.7	263.3	1234.8	12136.4	2256.8
				J	518.1	810.7	303.7	1230.9	12018.4	2090.3
			Min	I	-2193.0	140.8	-131.1	-65.4	2437.6	-15332.9
				J	-2190.7	140.8	-90.7	-69.3	2458.5	-15701.6
			INVSLE Max	I	403.7	499.6	961.7	2948.8	20825.9	-4087.0
				J	419.1	499.6	1032.4	2881.5	20630.5	-4272.7
			Min	I	-954.5	268.3	-423.0	-226.7	5812.6	-10362.9
				J	-952.2	268.3	-358.8	-280.1	5691.3	-10610.5
			INVSLEQP Max	I	-1154.5	537.3	16.7	460.6	7068.6	-6525.2
				J	-1152.2	537.3	57.1	456.7	7047.9	-6827.4
			Min	I	-1233.0	532.3	13.5	454.3	6964.1	-6741.6
				J	-1230.7	532.3	53.8	450.5	6945.1	-7041.0
			INVSLEF Max	I	66.0	398.6	666.2	2029.9	15905.9	-5164.9
				J	77.6	398.6	724.4	1986.4	15754.5	-5358.5
			Min	I	-583.1	311.7	-227.2	101.0	7437.9	-8094.6
				J	-580.8	311.7	-172.2	63.2	7347.9	-8309.6
1036	2	103	INVSLE Max	I	787.7	653.7	1427.9	4458.0	28057.0	-5071.0
				J	799.7	653.7	1495.0	4391.8	27803.0	-5243.7
			Min	I	-1596.4	298.8	-597.2	-316.6	3681.3	-14028.8
				J	-1594.8	298.8	-546.9	-365.6	3621.7	-14249.0
			INVSLE Min	I	532.1	769.7	321.2	1479.7	11984.5	2082.0
				J	533.7	769.7	349.3	1476.9	11878.7	1956.2
			Min	I	-2223.5	148.2	-109.2	-14.8	2452.1	-15699.5
				J	-2222.0	148.2	-81.1	-17.6	2461.6	-15941.8
			INVSLE Max	I	410.8	493.7	1032.7	3251.2	20592.9	-4277.8
				J	419.7	493.7	1082.4	3202.2	20414.5	-4406.9
			Min	I	-960.7	263.1	-358.3	-20.1	5673.1	-10626.4
				J	-959.1	263.1	-313.7	-57.2	5573.0	-10804.1
			INVSLEQP Max	I	-1162.6	512.7	56.4	604.8	7029.4	-6829.8
				J	-1161.0	512.7	84.4	602.1	7001.1	-7035.5
			Min	I	-1241.1	509.3	53.0	596.3	6927.0	-7043.5
				J	-1239.6	509.3	81.1	593.5	6900.0	-7247.7
			INVSLEF Max	I	69.5	395.3	724.8	2284.4	15727.3	-5363.4
				J	76.2	395.3	765.5	2252.8	15589.4	-5497.1
			Min	I	-588.1	308.1	-171.8	302.7	7332.0	-8321.8
				J	-586.5	308.1	-133.6	276.4	7254.2	-8475.3
1037	2	103	INVSLE Max	I	800.0	653.7	1500.7	4394.2	27802.9	-5243.8
				J	810.3	653.7	1568.3	4328.2	27528.7	-5416.4
			Min	I	-1594.6	298.8	-542.6	-363.8	3621.7	-14249.1
				J	-1593.0	298.8	-492.2	-414.7	3549.1	-14469.3
			INVSLE Min	I	550.8	769.6	371.9	1487.1	11880.0	1951.7
				J	552.3	769.6	399.9	1484.3	11753.3	1819.5
			Min	I	-2238.6	148.2	-95.2	-24.2	2460.1	-15937.5
				J	-2237.0	148.2	-67.1	-27.0	2464.5	-16173.5
			INVSLE Max	I	419.9	493.7	1086.6	3203.9	20414.5	-4407.0
				J	427.6	493.7	1136.7	3155.1	20221.2	-4536.0
			Min	I	-958.9	263.1	-309.4	-55.4	5572.9	-10804.2
				J	-957.3	263.1	-264.9	-93.8	5459.9	-10981.9
			INVSLEQP Max	I	-1160.8	512.7	88.7	603.9	7001.0	-7035.6
				J	-1159.2	512.7	116.7	601.1	6959.8	-7241.2
			Min	I	-1239.3	509.3	85.4	595.3	6900.0	-7247.8
				J	-1237.8	509.3	113.4	592.5	6860.1	-7452.1
			INVSLEF Max	I	76.5	395.3	769.7	2254.6	15589.4	-5497.2
				J	82.3	395.3	810.7	2222.9	15439.4	-5630.7
			Min	I	-586.3	308.1	-129.3	278.2	7254.1	-8475.4
				J	-584.7	308.1	-91.0	251.0	7163.3	-8629.0
1038	2	102	INVSLE Max	I	808.3	651.0	1568.4	4425.3	27516.5	-5417.1
				J	819.6	651.0	1665.3	4333.9	27094.4	-5659.4
			Min	I	-1595.1	298.3	-492.2	-363.2	3546.1	-14473.6
				J	-1592.9	298.3	-421.3	-437.2	3424.1	-14785.6
			INVSLE Min	I	569.4	762.6	419.8	1540.0	11747.3	1814.3
				J	571.7	762.6	460.5	1536.1	11537.3	1618.0
			Min	I	-2257.7	148.6	-87.2	-23.6	2462.0	-16169.3

Sovrapasso di ingresso - Ponte strallato - Relazione di calcolo

			J	-2255.5	148.6	-46.4	-27.6	2460.1	-16489.5	
			INVSLE Max	I	425.9	492.6	1136.7	3226.4	20212.2	-4537.0
				J	434.3	492.6	1208.5	3158.7	19913.5	-4718.3
			Min	I	-958.9	262.1	-264.7	-43.5	5456.1	-10985.0
				J	-956.6	262.1	-201.6	-99.3	5276.8	-11236.3
			INVSLEQP Max	I	-1161.2	507.9	116.6	630.1	6955.9	-7241.6
				J	-1159.0	507.9	157.3	626.2	6878.2	-7529.5
			Min	I	-1239.8	504.7	113.2	621.1	6856.2	-7452.6
				J	-1237.5	504.7	154.0	617.2	6780.4	-7738.6
			INVSLEF Max	I	80.7	394.7	810.7	2280.5	15432.8	-5631.6
				J	87.1	394.7	869.5	2236.4	15200.7	-5818.9
			Min	I	-586.1	307.4	-91.0	297.4	7159.9	-8631.3
				J	-583.9	307.4	-36.4	258.2	7012.1	-8848.4
1039	2	102	INVSLE Max	I	808.4	636.9	1665.9	4835.5	27020.1	-5662.4
				J	816.7	636.9	1775.6	4731.6	26448.6	-5926.6
			Min	I	-1603.7	295.2	-421.2	-171.0	3407.7	-14806.5
				J	-1601.2	295.2	-340.4	-254.3	3243.0	-15163.8
			INVSLE Min	I	589.6	724.2	485.0	1789.2	11497.2	1609.5
				J	592.1	724.2	530.9	1784.8	11217.2	1373.2
			Min	I	-2292.2	151.7	-71.9	24.6	2452.2	-16486.4
				J	-2289.7	151.7	-26.0	20.2	2438.1	-16810.8
			INVSLE Max	I	425.2	486.6	1208.8	3527.5	19858.8	-4722.8
				J	431.3	486.6	1290.1	3450.5	19451.3	-4922.5
			Min	I	-965.0	256.3	-201.1	160.3	5255.7	-11251.4
				J	-962.5	256.3	-129.3	97.4	5025.7	-11537.0
			INVSLEQP Max	I	-1169.3	482.2	156.5	776.8	6855.9	-7531.6
				J	-1166.8	482.2	202.4	772.3	6740.9	-7840.3
			Min	I	-1247.9	480.6	153.0	765.5	6758.5	-7740.9
				J	-1245.4	480.6	199.0	761.1	6645.7	-8048.6
			INVSLEF Max	I	78.5	391.3	869.8	2534.1	15159.9	-5823.2
				J	83.2	391.3	936.2	2484.2	14843.8	-6027.8
			Min	I	-591.2	303.5	-36.1	497.4	6992.6	-8859.9
				J	-588.7	303.5	26.1	453.1	6798.1	-9105.3
1040	2	102	INVSLE Max	I	810.9	629.9	1775.9	4978.1	26415.4	-5927.9
				J	816.2	629.9	1885.9	4876.4	25758.5	-6188.2
			Min	I	-1606.4	293.4	-340.4	-123.1	3234.3	-15173.6
				J	-1603.9	293.4	-261.0	-208.3	3039.7	-15534.7
			INVSLE Min	I	613.4	708.4	558.0	1916.1	11196.3	1366.1
				J	615.9	708.4	604.2	1911.7	10869.8	1113.9
			Min	I	-2320.3	149.7	-53.6	39.6	2432.8	-16806.1
				J	-2317.8	149.7	-7.4	35.1	2405.2	-17105.3
			INVSLE Max	I	426.7	483.6	1290.2	3631.9	19426.9	-4924.5
				J	430.6	483.6	1371.7	3556.6	18956.3	-5122.3
			Min	I	-966.6	253.2	-129.0	225.2	5014.4	-11544.1
				J	-964.2	253.2	-58.3	161.0	4754.0	-11831.6
			INVSLEQP Max	I	-1171.8	469.2	202.0	847.0	6728.6	-7841.2
				J	-1169.3	469.2	248.1	842.6	6583.9	-8142.7
			Min	I	-1250.4	468.4	198.5	834.6	6633.7	-8049.6
				J	-1247.9	468.4	244.7	830.2	6491.2	-8350.6
			INVSLEF Max	I	78.8	389.7	936.4	2630.7	14825.5	-6029.8
				J	81.9	389.7	1002.7	2581.8	14460.5	-6231.4
			Min	I	-592.3	301.5	26.2	571.0	6787.3	-9110.8
				J	-589.8	301.5	87.8	525.9	6562.5	-9357.2
1041	2	102	INVSLE Max	I	134.5	464.8	1621.5	3841.7	26010.4	-4766.2
				J	147.2	464.8	1729.4	3741.6	25459.5	-4980.7
			Min	I	-2056.1	208.5	-495.7	-1118.0	3204.2	-12108.8
				J	-2053.3	208.5	-415.1	-1203.4	3062.2	-12340.4
			INVSLE Min	I	525.6	649.4	443.7	1040.2	11062.1	2026.5
				J	528.3	649.4	489.8	1035.7	10801.0	1768.5
			Min	I	-2858.1	97.2	-62.4	-209.4	2455.1	-15256.3
				J	-2855.4	97.2	-16.2	-213.8	2441.2	-15478.0
			INVSLE Max	I	-67.2	374.2	1181.5	2805.4	19141.1	-4009.9
				J	-57.8	374.2	1261.4	2731.3	18745.6	-4190.3
			Min	I	-1334.5	192.9	-218.9	-518.3	4878.8	-9343.7
				J	-1331.7	192.9	-147.2	-582.8	4641.8	-9537.8
			INVSLEQP Max	I	-1426.2	423.4	175.8	426.8	6680.6	-7003.3
				J	-1423.5	423.4	221.9	422.4	6552.6	-7275.4
			Min	I	-1508.0	419.6	169.6	400.7	6589.9	-7224.9
				J	-1505.3	419.6	215.7	396.3	6466.0	-7494.6
			INVSLEF Max	I	-330.7	300.6	861.3	1972.4	14613.1	-5067.1
				J	-323.5	300.6	927.1	1923.5	14298.0	-5239.7
			Min	I	-887.4	245.7	-39.1	-4.2	6666.7	-7520.2
				J	-884.7	245.7	22.8	-48.5	6461.5	-7705.4
1042	2	102	INVSLE Max	I	138.2	435.7	1729.1	4359.0	25399.3	-4990.1
				J	161.6	435.7	1837.2	4253.8	24740.3	-5194.2
			Min	I	-2064.5	194.9	-416.3	-867.1	3054.8	-12369.0
				J	-2061.8	194.9	-334.7	-950.1	2883.6	-12595.1
			INVSLE Min	I	545.9	626.2	513.9	1340.8	10761.5	1759.0
				J	548.5	626.2	560.3	1336.3	10454.3	1486.4
			Min	I	-2893.3	55.3	-42.8	-133.2	2435.0	-15478.7

Sovrapasso di ingresso - Ponte strallato - Relazione di calcolo

			J	-2890.6	55.3	3.6	-137.7	2407.6	-15646.2	
			INVSLE Max	I	-65.4	348.8	1261.0	3186.2	18701.1	-4196.7
				J	-48.1	348.8	1341.1	3108.3	18225.7	-4366.6
			Min	I	-1341.4	178.2	-147.4	-257.3	4622.4	-9558.4
				J	-1338.8	178.2	-75.0	-320.0	4355.0	-9746.0
			INVSLEQP Max	I	-1434.9	381.5	220.4	614.3	6528.1	-7279.6
				J	-1432.2	381.5	266.7	609.9	6370.6	-7526.0
			Min	I	-1516.7	379.9	214.1	585.5	6442.4	-7499.0
				J	-1514.0	379.9	260.4	581.0	6289.0	-7744.3
			INVSLEF Max	I	-331.7	283.4	926.9	2291.8	14263.7	-5246.1
				J	-318.5	283.4	992.9	2240.4	13887.2	-5405.2
			Min	I	-892.8	233.6	22.4	251.4	6441.4	-7721.0
				J	-890.1	233.6	85.0	208.0	6205.7	-7900.3
1043	2	102	INVSLE Max	I	159.6	430.3	1837.1	4379.1	24726.3	-5195.9
				J	182.2	430.3	1931.4	4288.9	24087.7	-5371.8
			Min	I	-2064.0	191.9	-335.0	-881.8	2881.8	-12600.7
				J	-2061.7	191.9	-265.0	-959.6	2708.1	-12797.0
			INVSLE Min	I	569.3	638.1	585.0	1405.3	10446.3	1480.6
				J	571.6	638.1	625.5	1401.4	10141.3	1230.7
			Min	I	-2915.4	29.8	-21.6	-128.4	2404.9	-15642.3
				J	-2913.1	29.8	18.9	-132.3	2369.1	-15769.0
			INVSLE Max	I	-49.8	344.0	1341.0	3200.7	18215.4	-4367.8
				J	-33.0	344.0	1410.9	3133.8	17753.5	-4513.8
			Min	I	-1340.7	175.1	-75.0	-254.1	4350.6	-9750.1
				J	-1338.4	175.1	-12.7	-312.8	4092.5	-9912.5
			INVSLEQP Max	I	-1434.4	372.7	266.4	648.9	6365.0	-7526.8
				J	-1432.1	372.7	306.9	645.0	6203.1	-7737.0
			Min	I	-1516.3	371.7	260.1	619.5	6283.6	-7745.1
				J	-1514.0	371.7	300.6	615.6	6125.3	-7954.7
			INVSLEF Max	I	-320.3	280.1	992.9	2315.1	13879.2	-5406.4
				J	-307.6	280.1	1050.6	2270.8	13514.2	-5542.6
			Min	I	-891.8	231.1	85.0	268.7	6201.0	-7903.3
				J	-889.5	231.1	139.1	228.3	5970.8	-8058.6
1044	2	103	INVSLE Max	I	177.9	419.8	1931.3	4533.4	24067.1	-5375.1
				J	191.2	419.8	1997.7	4468.0	23563.5	-5497.8
			Min	I	-2065.8	185.7	-265.6	-825.7	2704.3	-12808.1
				J	-2064.3	185.7	-216.5	-883.5	2566.6	-12946.6
			INVSLE Min	I	586.1	640.3	644.1	1526.9	10122.5	1225.7
				J	587.7	640.3	672.4	1524.1	9884.3	1040.6
			Min	I	-2935.6	0.1	-0.9	-103.9	2365.5	-15767.6
				J	-2934.0	0.1	27.3	-106.7	2332.6	-15840.7
			INVSLE Max	I	-36.6	334.6	1410.7	3314.2	17738.3	-4516.0
				J	-26.7	334.6	1459.9	3265.8	17373.2	-4617.4
			Min	I	-1342.1	168.5	-12.8	-184.1	4083.5	-9920.6
				J	-1340.5	168.5	30.9	-227.7	3885.3	-10034.8
			INVSLEQP Max	I	-1436.5	355.1	306.2	721.8	6191.2	-7738.5
				J	-1434.9	355.1	334.4	719.0	6061.9	-7881.6
			Min	I	-1518.3	354.9	299.8	691.3	6113.8	-7956.3
				J	-1516.8	354.9	328.0	688.5	5987.1	-8099.4
			INVSLEF Max	I	-311.3	273.6	1050.5	2416.8	13502.0	-5544.8
				J	-303.8	273.6	1091.2	2384.6	13214.2	-5638.3
			Min	I	-892.7	225.9	138.9	346.9	5960.9	-8064.7
				J	-891.1	225.9	176.8	316.8	5782.5	-8173.9
1045	2	103	INVSLE Max	I	191.6	419.8	2003.4	4470.4	23563.4	-5497.9
				J	203.9	419.8	2071.8	4406.3	23053.6	-5620.6
			Min	I	-2064.0	185.7	-212.2	-881.8	2566.5	-12946.7
				J	-2062.4	185.7	-164.1	-941.1	2415.5	-13085.2
			INVSLE Min	I	604.4	657.0	695.4	1532.4	9885.3	1036.7
				J	606.0	657.0	723.6	1529.6	9627.9	845.3
			Min	I	-2950.2	-16.5	12.8	-111.4	2331.6	-15837.0
				J	-2948.7	-16.5	41.0	-114.2	2291.7	-15903.8
			INVSLE Max	I	-26.4	334.6	1464.1	3267.6	17373.1	-4617.5
				J	-17.3	334.6	1514.8	3220.1	17003.5	-4718.8
			Min	I	-1340.3	168.5	35.1	-225.9	3885.2	-10034.9
				J	-1338.7	168.5	78.1	-270.6	3673.8	-10149.1
			INVSLEQP Max	I	-1434.7	355.1	338.7	720.8	6061.9	-7881.7
				J	-1433.1	355.1	366.9	718.0	5919.5	-8024.9
			Min	I	-1516.5	354.9	332.3	690.3	5987.1	-8099.5
				J	-1514.9	354.9	360.5	687.5	5847.3	-8242.6
			INVSLEF Max	I	-303.5	273.6	1095.5	2386.4	13214.2	-5638.5
				J	-296.6	273.6	1136.6	2354.7	12922.0	-5731.9
			Min	I	-890.8	225.9	181.1	318.6	5782.4	-8174.0
				J	-889.2	225.9	218.5	287.9	5590.9	-8283.2
1046	2	102	INVSLE Max	I	198.8	410.0	2071.6	4676.6	23019.5	-5623.8
				J	212.5	410.0	2167.6	4586.7	22250.1	-5788.8
			Min	I	-2066.9	176.6	-164.7	-793.0	2411.1	-13096.9
				J	-2064.7	176.6	-97.0	-874.4	2183.5	-13285.9
			INVSLE Min	I	619.6	660.2	741.7	1667.5	9604.7	840.7
				J	621.9	660.2	781.9	1663.7	9222.2	567.0
			Min	I	-2971.2	-51.5	21.6	-81.9	2287.4	-15902.8

Sovrapasso di ingresso - Ponte strallato - Relazione di calcolo

			J	-2969.0	-51.5	61.7	-85.8	2220.9	-15968.9	
			INVSLEP Max	I	-21.5	325.5	1514.5	3419.8	16978.3	-4721.0
				J	-11.3	325.5	1585.6	3353.2	16419.5	-4856.4
			Min	I	-1342.8	159.5	78.0	-128.9	3662.9	-10157.6
				J	-1340.6	159.5	138.5	-190.2	3351.4	-10312.5
			INVSLEQP Max	I	-1438.0	335.6	366.0	803.1	5904.9	-8026.4
				J	-1435.7	335.6	406.2	799.2	5689.1	-8213.2
			Min	I	-1519.8	334.7	359.6	771.5	5833.2	-8244.2
				J	-1517.6	334.7	399.7	767.7	5621.0	-8431.5
			INVSLEF Max	I	-300.8	267.4	1136.5	2516.2	12901.9	-5734.2
				J	-293.1	267.4	1194.3	2471.6	12461.3	-5857.7
			Min	I	-892.8	219.0	218.3	418.8	5578.7	-8289.6
				J	-890.6	219.0	271.3	376.7	5294.6	-8437.8
1047	2	102	INVSLEP Max	I	208.1	403.4	2167.4	4804.5	22220.1	-5791.1
				J	219.4	403.4	2278.9	4791.3	21266.1	-5975.3
			Min	I	-2068.2	167.5	-97.6	-754.6	2179.6	-13295.2
				J	-2065.7	167.5	-19.5	-850.6	1889.0	-13510.9
			INVSLEF Max	I	640.5	672.9	804.9	1778.2	9202.1	561.9
				J	643.0	672.9	851.3	1773.7	8722.6	232.9
			Min	I	-2994.8	-90.9	37.4	-62.7	2216.8	-15966.5
				J	-2992.2	-90.9	83.8	-67.2	2121.7	-16013.4
			INVSLEP Max	I	-14.9	319.2	1585.4	3514.2	16397.4	-4858.0
				J	-6.5	319.2	1668.0	3504.4	15703.6	-5008.5
			Min	I	-1343.9	150.7	138.4	-76.1	3342.0	-10319.3
				J	-1341.4	150.7	208.3	-148.3	2953.9	-10495.4
			INVSLEQP Max	I	-1439.7	319.3	405.4	868.1	5676.3	-8214.4
				J	-1437.1	319.3	451.8	863.7	5399.2	-8419.4
			Min	I	-1521.5	317.5	398.9	835.7	5608.6	-8432.7
				J	-1518.9	317.5	445.3	831.2	5335.7	-8638.9
			INVSLEF Max	I	-296.6	262.7	1194.2	2601.7	12443.6	-5859.3
				J	-290.2	262.7	1261.2	2552.5	11896.9	-5996.3
			Min	I	-893.5	211.0	271.1	482.3	5283.9	-8442.9
				J	-891.0	211.0	332.4	432.9	4927.5	-8611.6
1048	2	102	INVSLEP Max	I	213.4	395.6	2278.8	5081.0	21231.1	-5977.0
				J	219.9	395.6	2389.3	5050.0	20201.2	-6138.0
			Min	I	-2069.9	155.0	-20.3	-700.8	1883.6	-13521.5
				J	-2067.4	155.0	56.3	-798.4	1565.7	-13732.4
			INVSLEF Max	I	661.8	686.2	874.9	1914.8	8694.6	227.9
				J	664.3	686.2	921.1	1910.4	8181.0	-111.9
			Min	I	-3020.1	-139.2	58.6	-36.4	2116.2	-16011.4
				J	-3017.6	-139.2	104.8	-40.8	1999.8	-16022.8
			INVSLEP Max	I	-11.3	311.5	1667.8	3718.8	15677.8	-5009.6
				J	-6.5	311.5	1749.6	3695.8	14927.8	-5141.3
			Min	I	-1345.5	138.8	208.1	-6.1	2941.2	-10503.1
				J	-1343.0	138.8	276.8	-79.6	2525.8	-10674.3
			INVSLEQP Max	I	-1442.0	298.0	450.8	949.9	5381.5	-8420.6
				J	-1439.5	298.0	497.0	945.5	5076.8	-8610.1
			Min	I	-1523.8	295.0	444.2	916.4	5318.6	-8640.1
				J	-1521.3	295.0	490.4	911.9	5018.1	-8831.5
			INVSLEF Max	I	-294.9	256.7	1261.0	2715.3	11875.9	-5998.1
				J	-291.2	256.7	1327.2	2665.9	11285.8	-6126.7
			Min	I	-894.7	199.7	332.2	564.7	4912.7	-8617.3
				J	-892.2	199.7	392.7	514.5	4528.7	-8781.3
1049	2	102	INVSLEP Max	I	-629.9	276.2	2047.2	3624.0	20639.3	-3253.0
				J	-625.7	276.2	2156.2	3526.0	19770.1	-3354.0
			Min	I	-2790.1	6.2	-234.8	-1746.1	1797.5	-9145.0
				J	-2785.7	6.2	-151.5	-1838.2	1518.9	-9208.3
			INVSLEF Max	I	375.8	634.6	696.0	1019.4	8463.0	1781.1
				J	378.5	634.6	742.4	1015.0	8052.3	1443.0
			Min	I	-3750.7	-265.2	59.2	-386.7	2137.1	-13462.9
				J	-3748.0	-265.2	105.6	-391.2	2029.8	-13362.9
			INVSLEP Max	I	-630.8	197.4	1504.7	2667.6	15251.1	-3032.5
				J	-627.7	197.4	1585.4	2595.0	14614.8	-3119.9
			Min	I	-1993.8	32.0	63.4	-799.4	2736.6	-7052.4
				J	-1989.9	32.0	137.2	-868.7	2346.7	-7107.0
			INVSLEQP Max	I	-1891.6	223.6	408.6	515.1	5254.5	-6632.7
				J	-1888.8	223.6	454.9	510.6	4975.5	-6776.2
			Min	I	-1975.2	222.5	399.8	469.5	5198.5	-6862.4
				J	-1972.5	222.5	446.2	465.1	4925.2	-7006.7
			INVSLEF Max	I	-894.0	157.4	1139.0	1945.7	11555.1	-4030.2
				J	-891.3	157.4	1205.1	1896.2	11040.6	-4107.2
			Min	I	-1436.0	103.2	218.5	-73.0	4716.3	-5852.7
				J	-1432.8	103.2	282.1	-119.2	4357.2	-5937.2
1050	2	102	INVSLEP Max	I	-627.8	255.3	2155.2	3772.6	19752.5	-3357.4
				J	-617.8	255.3	2264.2	3675.9	18800.6	-3439.2
			Min	I	-2787.2	-26.1	-153.1	-1699.4	1521.8	-9218.3
				J	-2783.0	-26.1	-70.0	-1792.7	1215.7	-9264.4
			INVSLEF Max	I	397.1	646.8	763.0	1133.1	8037.9	1438.0
				J	399.8	646.8	809.1	1128.7	7593.6	1092.9
			Min	I	-3772.3	-327.7	82.4	-351.1	2027.9	-13363.1

Sovrapasso di ingresso - Ponte strallato - Relazione di calcolo

			J	-3769.7	-327.7	128.6	-355.5	1899.0	-13222.7	
			INVSLE Max	I	-629.7	182.5	1584.6	2777.7	14601.4	-3122.2
				J	-622.2	182.5	1665.3	2706.1	13903.9	-3193.7
			Min	I	-1992.3	6.0	136.2	-738.8	2341.1	-7115.6
				J	-1988.6	6.0	209.7	-809.0	1923.9	-7159.8
			INVSLEQP Max	I	-1892.3	195.4	453.5	589.6	4963.7	-6778.3
				J	-1889.7	195.4	499.7	585.2	4657.2	-6902.1
			Min	I	-1975.9	193.1	444.7	543.2	4914.1	-7008.7
				J	-1973.3	193.1	490.8	538.8	4613.3	-7134.2
			INVSLEF Max	I	-893.6	143.3	1204.4	2043.7	11028.4	-4110.1
				J	-891.0	143.3	1270.4	1994.7	10466.8	-4173.5
			Min	I	-1435.0	81.8	281.3	1.4	4348.4	-5943.6
				J	-1431.9	81.8	344.9	-45.3	3961.7	-6018.5
1051	2	102	INVSLE Max	I	-617.2	260.3	2264.4	3620.2	18804.2	-3438.6
				J	-604.0	260.3	2360.1	3540.5	17930.6	-3513.5
			Min	I	-2782.7	-18.4	-69.6	-1823.8	1214.9	-9262.1
				J	-2779.5	-18.4	-1.0	-1914.2	921.8	-9306.4
			INVSLE Min	I	422.0	677.0	830.6	1107.0	7597.8	1088.7
				J	424.4	677.0	871.0	1103.1	7180.8	776.0
			Min	I	-3790.6	-346.0	107.7	-369.4	1898.7	-13217.3
				J	-3788.3	-346.0	148.1	-373.3	1764.7	-13090.6
			INVSLE Max	I	-621.7	185.9	1665.5	2664.8	13906.6	-3193.3
				J	-612.0	185.9	1736.4	2605.8	13266.2	-3258.6
			Min	I	-1988.0	12.2	209.9	-838.0	1925.2	-7157.9
				J	-1985.0	12.2	271.2	-906.0	1535.1	-7199.0
			INVSLEQP Max	I	-1888.9	202.1	500.0	567.5	4660.1	-6901.7
				J	-1886.5	202.1	540.4	563.6	4367.2	-7014.1
			Min	I	-1972.5	200.0	491.2	521.2	4616.0	-7133.7
				J	-1970.2	200.0	531.6	517.4	4328.1	-7247.3
			INVSLEF Max	I	-890.4	146.7	1270.6	1961.5	10469.4	-4172.9
				J	-886.3	146.7	1328.4	1920.8	9954.1	-4230.9
			Min	I	-1431.4	86.9	345.0	-72.3	3963.8	-6017.1
				J	-1428.8	86.9	399.2	-117.5	3600.5	-6084.7
1052	2	103	INVSLE Max	I	-608.8	220.2	2358.3	3967.2	17903.5	-3517.7
				J	-598.6	220.2	2424.2	3992.0	17216.6	-3549.1
			Min	I	-2781.0	-84.3	-3.8	-1676.8	927.7	-9325.6
				J	-2779.0	-84.3	44.8	-1739.4	705.5	-9336.8
			INVSLE Min	I	432.5	671.0	882.1	1304.0	7149.8	773.4
				J	434.1	671.0	910.2	1301.2	6839.7	550.2
			Min	I	-3806.0	-436.1	132.1	-303.2	1761.8	-13096.2
				J	-3804.4	-436.1	160.2	-306.0	1653.3	-12967.0
			INVSLE Max	I	-616.1	162.7	1734.8	2922.4	13245.3	-3261.6
				J	-608.6	162.7	1783.6	2940.7	12741.3	-3290.0
			Min	I	-1988.8	-40.6	269.4	-687.1	1524.4	-7214.8
				J	-1986.9	-40.6	312.7	-734.3	1232.9	-7231.9
			INVSLEQP Max	I	-1892.3	148.2	537.7	697.8	4343.2	-7017.3
				J	-1890.7	148.2	565.7	695.1	4121.6	-7074.9
			Min	I	-1975.8	143.8	528.7	650.1	4305.6	-7250.4
				J	-1974.3	143.8	556.8	647.3	4087.6	-7309.8
			INVSLEF Max	I	-890.9	119.7	1326.9	2174.9	9933.6	-4235.0
				J	-883.4	119.7	1366.6	2143.7	9530.0	-4260.8
			Min	I	-1432.5	45.6	397.7	87.0	3582.9	-6096.2
				J	-1430.8	45.6	435.5	55.5	3310.4	-6133.4
1053	2	103	INVSLE Max	I	-598.3	220.2	2429.9	3994.4	17216.5	-3549.2
				J	-586.6	220.2	2497.9	3975.2	16534.1	-3580.4
			Min	I	-2778.8	-84.3	49.1	-1737.6	705.4	-9336.9
				J	-2776.9	-84.3	96.5	-1802.1	469.4	-9348.4
			INVSLE Min	I	450.0	690.9	929.2	1306.2	6839.8	547.2
				J	451.6	690.9	957.2	1303.5	6517.2	319.4
			Min	I	-3819.9	-456.1	149.7	-307.4	1653.1	-12964.2
				J	-3818.4	-456.1	177.8	-310.1	1531.2	-12830.3
			INVSLE Max	I	-608.4	162.7	1787.9	2942.5	12741.2	-3290.1
				J	-599.7	162.7	1838.2	2928.4	12240.6	-3318.4
			Min	I	-1986.7	-40.6	317.0	-732.5	1232.9	-7232.0
				J	-1984.9	-40.6	359.4	-781.0	928.1	-7249.3
			INVSLEQP Max	I	-1890.5	148.2	570.0	696.8	4121.6	-7075.0
				J	-1888.9	148.2	598.1	694.1	3887.0	-7132.6
			Min	I	-1974.0	143.8	561.0	649.1	4087.6	-7309.9
				J	-1972.4	143.8	589.1	646.4	3856.6	-7369.3
			INVSLEF Max	I	-883.2	119.7	1370.8	2145.5	9530.0	-4260.9
				J	-874.5	119.7	1411.6	2114.7	9127.8	-4286.6
			Min	I	-1430.6	45.6	439.8	57.3	3310.3	-6133.5
				J	-1428.9	45.6	476.9	25.1	3024.6	-6170.7
1054	2	102	INVSLE Max	I	-588.5	204.5	2497.1	4136.7	16520.2	-3581.5
				J	-575.5	204.5	2592.7	4110.3	15478.7	-3612.9
			Min	I	-2777.0	-110.9	95.3	-1717.3	471.5	-9355.2
				J	-2774.5	-110.9	163.5	-1807.0	117.3	-9360.5
			INVSLE Min	I	464.7	702.7	970.5	1378.1	6504.0	317.0
				J	467.0	702.7	1011.2	1374.2	6035.0	-7.3
			Min	I	-3834.6	-505.6	162.4	-288.2	1529.8	-12830.7

Sovrapasso di ingresso - Ponte strallato - Relazione di calcolo

			J	-3832.3	-505.6	203.1	-292.1	1333.8	-12617.7		
		INVSLEP	Max	I	-601.3	153.9	1837.5	3048.3	12230.0	-3319.1	
				J	-591.7	153.9	1908.3	3028.7	11465.4	-3348.7	
			Min	I	-1986.0	-62.0	358.7	-703.8	923.8	-7254.7	
				J	-1983.6	-62.0	419.7	-771.3	474.0	-7272.6	
		INVSLEQP	Max	I	-1890.8	127.1	597.0	741.6	3877.0	-7133.6	
				J	-1888.6	127.1	637.6	737.7	3527.2	-7202.3	
			Min	I	-1974.3	121.8	587.9	693.4	3847.2	-7370.3	
				J	-1972.0	121.8	628.6	689.5	3502.5	-7442.1	
		INVSLEF	Max	I	-876.2	109.2	1411.0	2206.1	9117.7	-4287.8	
				J	-866.6	109.2	1468.5	2163.1	8505.1	-4315.4	
			Min	I	-1430.1	29.3	476.3	97.6	3017.1	-6174.5	
				J	-1427.8	29.3	530.0	53.0	2594.1	-6221.1	
1055	2	102	INVSLEP	Max	I	-576.6	195.8	2592.3	4194.5	15471.4	-3613.3
				J	-564.6	195.8	2702.7	4167.2	14251.9	-3640.5	
			Min	I	-2774.4	-125.7	162.9	-1763.6	118.5	-9364.1	
				J	-2771.6	-125.7	240.3	-1871.0	-324.5	-9363.8	
		INVSLEF	Max	I	486.0	724.4	1028.6	1415.1	6027.4	-10.5	
				J	488.5	724.4	1074.9	1410.7	5478.9	-384.2	
			Min	I	-3852.9	-548.2	184.6	-283.6	1333.1	-12615.8	
				J	-3850.4	-548.2	230.9	-288.0	1069.0	-12355.3	
		INVSLEP	Max	I	-592.6	149.0	1908.0	3091.3	11459.8	-3348.9	
				J	-583.7	149.0	1989.8	3071.1	10564.3	-3375.6	
			Min	I	-1984.1	-73.8	419.3	-732.3	471.7	-7275.5	
				J	-1981.4	-73.8	488.7	-813.0	-71.9	-7292.1	
		INVSLEQP	Max	I	-1889.5	115.4	637.0	761.8	3521.6	-7202.8	
				J	-1887.0	115.4	683.3	757.4	3095.6	-7273.2	
			Min	I	-1973.0	109.5	627.9	713.4	3497.2	-7442.5	
				J	-1970.4	109.5	674.2	709.0	3077.1	-7516.7	
		INVSLEF	Max	I	-867.6	103.3	1468.1	2211.2	8499.6	-4315.9	
				J	-858.6	103.3	1534.3	2233.0	7780.7	-4341.5	
			Min	I	-1428.3	20.3	529.7	89.9	2589.9	-6223.1	
				J	-1425.7	20.3	590.8	36.7	2076.6	-6272.4	
1056	2	102	INVSLEP	Max	I	-568.6	166.8	2701.2	4455.9	14227.1	-3640.8
				J	-560.8	166.8	2810.0	4428.1	12932.0	-3638.8	
			Min	I	-2770.4	-189.3	237.9	-1725.9	-321.3	-9375.5	
				J	-2767.8	-189.3	313.7	-1832.8	-813.7	-9349.9	
		INVSLEF	Max	I	502.8	735.5	1089.2	1538.6	5449.9	-385.5	
				J	505.3	735.5	1135.3	1534.1	4898.2	-754.6	
			Min	I	-3869.5	-636.6	212.2	-251.4	1066.4	-12358.1	
				J	-3867.0	-636.6	258.2	-255.8	754.0	-12051.9	
		INVSLEP	Max	I	-587.0	130.9	1988.4	3286.1	10545.3	-3375.7	
				J	-581.3	130.9	2069.0	3265.5	9593.9	-3378.3	
			Min	I	-1982.8	-117.5	487.1	-684.5	-80.7	-7300.9	
				J	-1980.2	-117.5	555.2	-764.9	-656.8	-7302.4	
		INVSLEQP	Max	I	-1890.0	72.0	680.9	837.1	3074.2	-7274.6	
				J	-1887.5	72.0	726.9	832.7	2622.8	-7315.6	
			Min	I	-1973.3	64.3	671.7	788.0	3056.9	-7518.0	
				J	-1970.8	64.3	717.7	783.6	2611.4	-7564.0	
		INVSLEF	Max	I	-862.0	81.6	1533.1	2398.6	7761.3	-4342.6	
				J	-856.3	81.6	1598.6	2377.5	6996.9	-4347.7	
			Min	I	-1427.5	-13.0	589.5	159.3	2060.3	-6278.5	
				J	-1425.0	-13.0	649.8	106.4	1514.3	-6313.7	
1057	2	102	INVSLEP	Max	I	-990.2	68.9	2360.1	2155.2	13287.6	-872.8
				J	-986.6	68.9	2471.3	2073.3	12263.9	-701.2	
			Min	I	-3504.3	-519.5	-121.3	-3280.8	-682.1	-6711.1	
				J	-3499.7	-519.5	-36.0	-3377.4	-1096.4	-6518.9	
		INVSLEF	Max	I	403.6	644.1	754.6	255.1	5072.8	417.7	
				J	406.2	644.1	800.6	250.7	4706.9	106.5	
			Min	I	-4349.0	-832.3	129.2	-1273.5	845.0	-10658.5	
				J	-4346.4	-832.3	175.2	-1277.9	614.5	-10226.1	
		INVSLEP	Max	I	-913.6	41.3	1717.0	1501.1	9865.5	-1274.3	
				J	-910.9	41.3	1799.4	1440.4	9126.8	-1144.3	
			Min	I	-2593.5	-366.8	220.8	-1920.7	-534.3	-5106.6	
				J	-2589.4	-366.8	295.8	-1993.5	-1040.0	-4980.0	
		INVSLEQP	Max	I	-2233.7	-94.0	427.6	-505.8	2777.3	-5796.8	
				J	-2231.1	-94.0	473.6	-510.2	2488.3	-5732.7	
			Min	I	-2316.8	-99.6	416.1	-566.3	2767.6	-6044.3	
				J	-2314.2	-99.6	462.1	-570.8	2486.0	-5983.8	
		INVSLEF	Max	I	-1151.7	-28.4	1304.7	1002.6	7201.4	-2599.9	
				J	-1149.1	-28.4	1371.9	959.5	6597.8	-2487.7	
			Min	I	-1880.6	-192.5	360.4	-948.3	1614.9	-4489.3	
				J	-1877.4	-192.5	425.0	-994.6	1143.4	-4423.4	
1058	2	102	INVSLEP	Max	I	-984.8	24.3	2467.9	2337.1	12292.5	-707.4
				J	-981.1	24.3	2580.8	2266.0	11180.3	-483.1	
			Min	I	-3487.0	-611.3	-39.7	-3230.0	-1072.4	-6531.6	
				J	-3482.6	-611.3	46.7	-3328.9	-1534.7	-6297.1	
		INVSLEF	Max	I	420.9	648.3	810.9	358.3	4707.1	104.1	
				J	423.5	648.3	857.4	353.8	4319.6	-194.0	
			Min	I	-4356.2	-941.5	158.7	-1230.2	632.9	-10234.4	

Sovrapasso di ingresso - Ponte strallato - Relazione di calcolo

			J	-4353.6	-941.5	205.2	-1234.7	362.5	-9746.0	
			INVSLE Max	I	-909.7	10.0	1796.6	1637.9	9149.2	-1149.1
				J	-906.9	10.0	1880.3	1585.2	8346.2	-977.1
			Min	I	-2583.3	-432.2	293.3	-1870.6	-1029.9	-4989.2
				J	-2579.4	-432.2	369.4	-1945.0	-1574.0	-4834.8
			INVSLEQP Max	I	-2228.5	-153.3	470.1	-435.7	2495.9	-5737.9
				J	-2225.9	-153.3	516.6	-440.2	2183.4	-5633.3
			Min	I	-2311.4	-161.1	458.5	-496.7	2495.3	-5988.8
				J	-2308.8	-161.1	505.0	-501.2	2176.4	-5889.3
			INVSLEF Max	I	-1148.2	-60.6	1369.5	1115.1	6609.0	-2492.6
				J	-1145.7	-60.6	1437.5	1076.9	5953.9	-2346.2
			Min	I	-1873.3	-242.6	422.8	-878.8	1143.5	-4431.6
				J	-1870.1	-242.6	488.4	-926.1	626.9	-4343.8
1059	2	102	INVSLE Max	I	-981.4	31.0	2581.4	2226.9	11175.1	-482.4
				J	-974.3	31.0	2679.8	2169.3	10174.3	-292.9
			Min	I	-3484.7	-596.8	47.3	-3349.3	-1538.6	-6295.1
				J	-3481.0	-596.8	121.0	-3442.2	-1998.8	-6097.5
			INVSLEF Max	I	445.1	677.6	872.9	337.3	4318.5	-196.9
				J	447.4	677.6	913.3	333.4	3968.0	-449.2
			Min	I	-4376.2	-954.3	190.7	-1239.9	360.6	-9741.4
				J	-4373.9	-954.3	231.0	-1243.7	90.1	-9333.0
			INVSLE Max	I	-907.2	14.8	1880.7	1555.8	8342.2	-976.5
				J	-901.9	14.8	1953.6	1513.2	7619.0	-831.4
			Min	I	-2580.4	-421.9	369.8	-1961.4	-1575.7	-4833.4
				J	-2577.1	-421.9	434.8	-2031.2	-2078.0	-4703.3
			INVSLEQP Max	I	-2226.4	-144.0	517.2	-450.6	2181.9	-5632.5
				J	-2224.2	-144.0	557.5	-454.5	1886.1	-5547.1
			Min	I	-2309.4	-151.5	505.6	-511.5	2175.2	-5888.5
				J	-2307.1	-151.5	545.9	-515.4	1872.9	-5807.3
			INVSLEF Max	I	-1145.8	-55.6	1437.9	1054.1	5951.7	-2345.5
				J	-1143.6	-55.6	1497.0	1022.8	5356.9	-2222.2
			Min	I	-1870.8	-234.7	488.7	-941.9	627.1	-4342.6
				J	-1868.1	-234.7	545.1	-986.4	148.1	-4269.6
1060	2	103	INVSLE Max	I	-972.7	4.2	2677.3	2336.2	10208.6	-295.6
				J	-965.0	4.2	2745.4	2377.5	9447.5	-137.0
			Min	I	-3470.6	-664.1	118.3	-3360.0	-1991.2	-6106.5
				J	-3468.1	-664.1	170.0	-3428.0	-2547.1	-5946.8
			INVSLEF Max	I	457.8	681.4	919.8	401.9	3965.9	-450.2
				J	459.4	681.4	948.0	399.1	3708.3	-615.8
			Min	I	-4379.6	-1034.8	219.9	-1223.0	106.2	-9339.0
				J	-4378.0	-1034.8	248.0	-1225.8	-106.3	-9030.7
			INVSLE Max	I	-900.6	-7.5	1951.6	1639.1	7645.4	-833.7
				J	-894.9	-7.5	2002.0	1669.6	7152.7	-711.5
			Min	I	-2571.8	-469.9	432.9	-1968.2	-2069.2	-4709.3
				J	-2569.5	-469.9	478.5	-2019.3	-2444.7	-4604.2
			INVSLEQP Max	I	-2221.6	-187.4	554.9	-411.9	1893.2	-5550.5
				J	-2220.1	-187.4	583.1	-414.7	1668.9	-5471.3
			Min	I	-2304.4	-196.4	543.2	-472.9	1878.7	-5810.6
				J	-2302.8	-196.4	571.4	-475.7	1649.6	-5735.0
			INVSLEF Max	I	-1142.6	-79.1	1495.3	1119.4	5373.1	-2224.8
				J	-1141.1	-79.1	1536.0	1096.3	4919.4	-2121.6
			Min	I	-1864.6	-271.5	543.5	-924.0	147.6	-4274.8
				J	-1862.8	-271.5	583.1	-956.7	-211.4	-4213.1
1061	2	103	INVSLE Max	I	-964.6	4.2	2751.1	2379.9	9447.4	-137.1
				J	-955.9	4.2	2821.5	2364.1	8697.4	22.3
			Min	I	-3467.9	-664.1	174.2	-3426.2	-2547.2	-5946.9
				J	-3465.4	-664.1	225.3	-3494.8	-3129.3	-5787.8
			INVSLEF Max	I	474.8	700.3	962.4	400.8	3707.0	-617.6
				J	476.3	700.3	990.6	398.0	3442.3	-772.6
			Min	I	-4393.0	-1053.7	242.1	-1223.9	-105.2	-9029.1
				J	-4391.4	-1053.7	270.2	-1226.7	-336.7	-8731.5
			INVSLE Max	I	-894.7	-7.5	2006.3	1671.4	7152.7	-711.6
				J	-888.2	-7.5	2058.4	1659.7	6718.2	-588.7
			Min	I	-2569.3	-469.9	482.8	-2017.5	-2444.8	-4604.3
				J	-2567.0	-469.9	527.9	-2069.0	-2835.9	-4499.6
			INVSLEQP Max	I	-2219.8	-187.4	587.3	-412.9	1668.8	-5471.4
				J	-2218.3	-187.4	615.5	-415.6	1431.4	-5392.1
			Min	I	-2302.6	-196.4	575.6	-473.9	1649.6	-5735.1
				J	-2301.0	-196.4	603.8	-476.6	1407.5	-5659.5
			INVSLEF Max	I	-1140.9	-79.1	1540.3	1098.0	4919.3	-2121.7
				J	-1139.3	-79.1	1582.2	1075.5	4468.3	-2018.1
			Min	I	-1862.5	-271.5	587.3	-954.9	-211.4	-4213.2
				J	-1860.7	-271.5	626.6	-987.6	-586.0	-4151.8
1062	2	102	INVSLE Max	I	-955.2	-7.3	2820.4	2426.1	8707.8	21.6
				J	-945.5	-7.3	2919.1	2406.3	7788.8	260.5
			Min	I	-3460.3	-694.5	224.0	-3467.0	-3125.2	-5791.9
				J	-3456.8	-694.5	296.0	-3562.5	-3981.9	-5587.7
			INVSLEF Max	I	489.7	713.1	999.1	425.2	3439.9	-773.8
				J	491.9	713.1	1039.6	421.3	3061.4	-959.5
			Min	I	-4402.2	-1101.0	259.6	-1222.1	-327.8	-8733.2

Sovrappasso di ingresso - Ponte strallato - Relazione di calcolo

			J	-4400.0	-1101.0	300.1	-1226.0	-682.4	-8328.2	
			INVSLE Max	I	-887.7	-17.4	2057.5	1706.9	6718.4	-589.4
				J	-880.5	-17.4	2130.6	1692.2	6075.9	-404.9
			Min	I	-2564.4	-491.6	527.1	-2050.0	-2831.4	-4502.2
				J	-2561.2	-491.6	590.9	-2121.8	-3403.2	-4370.4
			INVSLEQP Max	I	-2216.9	-206.9	614.3	-400.6	1434.7	-5393.6
				J	-2214.7	-206.9	654.7	-404.5	1083.3	-5271.1
			Min	I	-2299.6	-216.6	602.5	-461.5	1410.2	-5660.9
				J	-2297.4	-216.6	643.0	-465.4	1052.2	-5544.0
			INVSLEF Max	I	-1138.8	-89.7	1581.4	1111.9	4472.9	-2019.0
				J	-1136.6	-89.7	1640.4	1115.1	3807.4	-1864.0
			Min	I	-1858.9	-288.1	625.8	-967.0	-586.0	-4154.0
				J	-1856.3	-288.1	681.7	-1012.4	-1134.6	-4062.2
1063	2	102	INVSLE Max	I	-944.3	-25.9	2917.2	2492.5	7817.3	259.9
				J	-934.9	-25.9	3030.6	2474.0	6883.4	559.7
			Min	I	-3448.1	-744.1	294.0	-3527.9	-3974.0	-5593.7
				J	-3444.3	-744.1	374.8	-3638.6	-5008.6	-5350.9
			INVSLE Min	I	507.5	726.7	1049.0	461.1	3057.2	-960.6
				J	510.0	726.7	1095.1	456.7	2617.8	-1106.7
			Min	I	-4410.9	-1171.0	287.0	-1224.2	-667.2	-8331.5
				J	-4408.4	-1171.0	333.1	-1228.6	-1115.5	-7899.5
			INVSLE Max	I	-879.5	-33.5	2129.1	1758.4	6076.0	-405.6
				J	-872.6	-33.5	2213.0	1744.6	5316.3	-173.4
			Min	I	-2556.6	-526.9	589.5	-2101.6	-3394.9	-4373.8
				J	-2553.1	-526.9	661.3	-2184.8	-4079.7	-4217.9
			INVSLEQP Max	I	-2212.1	-238.7	652.7	-384.8	1089.0	-5273.4
				J	-2209.6	-238.7	698.8	-389.3	662.6	-5112.8
			Min	I	-2294.6	-249.7	640.9	-445.6	1056.9	-5546.1
				J	-2292.1	-249.7	687.0	-450.0	622.9	-5392.5
			INVSLEF Max	I	-1135.5	-107.1	1639.1	1164.1	3815.2	-1865.1
				J	-1133.1	-107.1	1706.7	1147.7	3029.3	-1670.8
			Min	I	-1853.1	-315.1	680.5	-987.8	-1134.1	-4065.3
				J	-1850.3	-315.1	743.6	-1040.3	-1792.7	-3949.9
1064	2	102	INVSLE Max	I	-933.5	-45.8	3028.5	2547.8	6916.9	559.7
				J	-923.9	-45.8	3140.8	2529.3	5950.6	896.5
			Min	I	-3434.2	-797.8	372.5	-3614.0	-4998.5	-5357.3
				J	-3430.6	-797.8	452.0	-3725.9	-6095.0	-5095.8
			INVSLE Min	I	526.1	740.9	1104.6	493.6	2612.4	-1107.7
				J	528.6	740.9	1150.5	489.2	2167.9	-1155.2
			Min	I	-4418.6	-1246.1	319.8	-1234.0	-1097.6	-7902.9
				J	-4416.2	-1246.1	365.7	-1238.4	-1594.7	-7531.4
			INVSLE Max	I	-871.4	-50.8	2211.4	1802.1	5317.8	-173.7
				J	-864.2	-50.8	2294.6	1788.4	4525.9	87.1
			Min	I	-2547.5	-565.2	659.8	-2176.3	-4069.4	-4221.3
				J	-2544.3	-565.2	730.6	-2260.4	-4788.7	-4058.7
			INVSLEQP Max	I	-2206.3	-273.2	696.6	-374.7	669.0	-5115.1
				J	-2203.9	-273.2	742.6	-379.1	215.8	-4932.1
			Min	I	-2288.7	-285.3	684.7	-435.1	628.2	-5394.6
				J	-2286.3	-285.3	730.7	-439.5	167.4	-5219.5
			INVSLEF Max	I	-1131.7	-125.8	1705.2	1188.7	3039.6	-1671.5
				J	-1129.3	-125.8	1772.0	1172.0	2221.8	-1458.6
			Min	I	-1846.5	-344.4	742.3	-1025.0	-1791.2	-3952.9
				J	-1843.7	-344.4	804.8	-1077.9	-2484.7	-3826.2
1065	2	102	INVSLE Max	I	-1463.1	-154.2	2688.4	605.6	6453.9	4648.3
				J	-1460.0	-154.2	2807.6	541.5	5768.9	5324.0
			Min	I	-4215.1	-1332.1	-103.9	-5538.2	-5794.6	-3094.8
				J	-4211.1	-1332.1	-11.5	-5630.3	-6839.1	-2692.0
			INVSLE Min	I	220.5	542.0	622.7	-781.2	2405.7	843.0
				J	222.8	542.0	669.3	-785.7	2172.0	1051.1
			Min	I	-4970.5	-1606.6	132.7	-3073.1	-1302.1	-5734.8
				J	-4968.2	-1606.6	179.3	-3077.6	-1588.6	-5252.0
			INVSLE Max	I	-1296.3	-170.0	1903.3	251.5	4810.4	3000.3
				J	-1294.0	-170.0	1991.6	216.2	4188.4	3532.0
			Min	I	-3237.0	-949.2	330.0	-3600.8	-4540.1	-2178.0
				J	-3233.4	-949.2	410.5	-3670.2	-5170.9	-1968.3
			INVSLEQP Max	I	-2738.8	-650.5	208.1	-2554.4	547.9	-2582.8
				J	-2736.6	-650.5	254.7	-2558.9	408.0	-2152.4
			Min	I	-2819.8	-663.2	192.4	-2630.7	496.5	-2864.6
				J	-2817.5	-663.2	239.0	-2635.1	346.4	-2442.5
			INVSLEF Max	I	-1538.7	-297.9	1424.5	-231.3	2541.4	955.3
				J	-1536.4	-297.9	1495.8	-266.5	1885.5	1358.0
			Min	I	-2406.0	-634.3	447.8	-2327.6	-2271.2	-1925.5
				J	-2403.2	-634.3	516.7	-2369.3	-2868.0	-1717.1
1066	2	102	INVSLE Max	I	-1460.4	-151.7	2807.8	541.3	5763.6	5324.4
				J	-1457.3	-151.7	2928.0	483.3	5048.8	6075.7
			Min	I	-4212.6	-1327.2	-11.3	-5632.2	-6841.2	-2691.6
				J	-4208.6	-1327.2	79.8	-5726.4	-7934.5	-2295.0
			INVSLE Min	I	244.1	569.0	678.5	-789.7	2167.3	1051.7
				J	246.4	569.0	724.8	-794.1	1912.0	1409.2
			Min	I	-4990.7	-1627.8	170.4	-3074.6	-1588.6	-5251.9

Sovrapasso di ingresso - Ponte strallato - Relazione di calcolo

			J	-4988.5	-1627.8	216.6	-3079.0	-1909.4	-4927.5	
			INVSLE Max	I	-1294.4	-167.9	1991.8	213.3	4186.5	3532.4
				J	-1292.1	-167.9	2080.8	180.9	3537.3	4113.7
			Min	I	-3234.3	-945.6	410.7	-3670.2	-5172.9	-1968.2
				J	-3230.8	-945.6	490.1	-3741.1	-5833.9	-1817.1
			INVSLEQP Max	I	-2737.3	-647.2	254.9	-2559.5	404.9	-2151.9
				J	-2735.0	-647.2	301.1	-2563.9	236.1	-1727.0
			Min	I	-2818.3	-659.8	239.2	-2635.8	343.4	-2442.0
				J	-2816.0	-659.8	285.4	-2640.2	164.5	-2025.2
			INVSLEF Max	I	-1536.7	-295.8	1496.0	-266.7	1882.9	1358.2
				J	-1534.5	-295.8	1567.6	-299.0	1200.0	1756.5
			Min	I	-2403.9	-631.4	516.9	-2369.6	-2869.3	-1717.0
				J	-2401.1	-631.4	585.3	-2411.9	-3496.6	-1512.4
1067	2	102	INVSLE Max	I	-1452.2	-181.9	2925.3	471.1	5111.6	6070.6
				J	-1449.3	-181.9	3030.7	420.5	4439.3	6779.8
			Min	I	-4190.7	-1386.3	77.1	-5716.1	-7907.4	-2299.0
				J	-4187.3	-1386.3	156.4	-5807.4	-8916.7	-2025.2
			INVSLE Min	I	263.7	576.1	729.5	-775.8	1927.0	1404.9
				J	265.7	576.1	770.2	-779.8	1683.5	1872.4
			Max	I	-4990.7	-1704.0	207.2	-3094.1	-1866.5	-4932.5
				J	-4988.8	-1704.0	247.9	-3098.0	-2177.3	-4760.0
			INVSLE Max	I	-1287.5	-193.1	2078.6	208.3	3559.4	4109.2
				J	-1285.4	-193.1	2156.7	179.8	2953.3	4656.8
			Min	I	-3219.9	-989.3	488.2	-3754.1	-5808.0	-1817.2
				J	-3216.9	-989.3	557.5	-3822.8	-6418.3	-1680.6
			INVSLEQP Max	I	-2725.7	-686.9	298.4	-2559.8	273.9	-1733.2
				J	-2723.7	-686.9	339.1	-2563.7	102.1	-1335.7
			Min	I	-2806.4	-700.6	282.6	-2635.2	201.1	-2031.2
				J	-2804.4	-700.6	323.3	-2639.2	20.4	-1641.5
			INVSLEF Max	I	-1529.9	-320.9	1565.7	-306.4	1231.0	1753.5
				J	-1528.0	-320.9	1628.4	-334.9	595.3	2124.7
			Min	I	-2392.8	-666.0	583.5	-2419.3	-3479.6	-1513.0
				J	-2390.4	-666.0	643.4	-2461.1	-4060.3	-1319.1
1068	2	103	INVSLE Max	I	-1443.2	-216.0	3027.6	393.0	4510.2	6774.2
				J	-1437.8	-216.0	3101.2	362.7	4001.1	7301.1
			Min	I	-4166.0	-1453.3	153.4	-5810.5	-8882.5	-2029.4
				J	-4163.8	-1453.3	208.3	-5873.8	-9621.2	-1883.4
			INVSLE Min	I	278.3	576.1	772.6	-760.9	1700.9	1866.0
				J	279.6	576.1	800.6	-763.7	1519.1	2285.4
			Max	I	-4983.2	-1782.1	240.1	-3121.8	-2127.7	-4764.4
				J	-4981.9	-1782.1	268.1	-3124.6	-2362.6	-4700.7
			INVSLE Max	I	-1280.0	-221.5	2154.2	202.5	2978.4	4651.8
				J	-1276.0	-221.5	2208.7	188.4	2525.4	5059.0
			Min	I	-3203.7	-1038.9	555.3	-3852.7	-6386.7	-1680.5
				J	-3201.7	-1038.9	603.2	-3900.3	-6833.1	-1573.5
			INVSLEQP Max	I	-2712.4	-731.7	336.0	-2561.6	145.7	-1342.9
				J	-2711.0	-731.7	364.0	-2564.4	11.9	-1043.8
			Min	I	-2792.9	-746.8	320.1	-2636.0	62.6	-1648.5
				J	-2791.5	-746.8	348.1	-2638.8	-77.5	-1355.4
			INVSLEF Max	I	-1522.5	-349.3	1626.2	-352.2	631.0	2121.3
				J	-1521.1	-349.3	1669.6	-366.4	157.2	2399.4
			Min	I	-2380.5	-705.2	641.4	-2481.2	-4039.3	-1319.6
				J	-2378.9	-705.2	682.9	-2509.8	-4464.9	-1171.6
1069	2	103	INVSLE Max	I	-1437.5	-216.0	3106.9	365.1	4001.1	7301.0
				J	-1431.1	-216.0	3180.9	349.2	3482.5	7828.3
			Min	I	-4163.6	-1453.3	212.5	-5872.0	-9621.3	-1883.5
				J	-4161.4	-1453.3	266.7	-5935.7	-10385.8	-1741.8
			INVSLE Min	I	294.4	593.4	810.8	-762.7	1516.6	2286.6
				J	295.7	593.4	838.8	-765.5	1325.6	2761.0
			Max	I	-4996.3	-1799.4	266.5	-3122.0	-2360.2	-4702.0
				J	-4994.9	-1799.4	294.5	-3124.8	-2611.7	-4693.4
			INVSLE Max	I	-1275.8	-221.5	2212.9	190.2	2525.3	5058.9
				J	-1271.0	-221.5	2267.7	180.3	2060.9	5466.5
			Min	I	-3201.5	-1038.9	607.5	-3898.5	-6833.1	-1573.6
				J	-3199.6	-1038.9	654.8	-3946.4	-7295.0	-1466.9
			INVSLEQP Max	I	-2710.8	-731.7	368.2	-2562.6	11.9	-1043.9
				J	-2709.5	-731.7	396.2	-2565.3	-134.8	-744.8
			Min	I	-2791.3	-746.8	352.4	-2637.0	-77.6	-1355.5
				J	-2790.0	-746.8	380.4	-2639.8	-230.6	-1062.4
			INVSLEF Max	I	-1520.9	-349.3	1673.9	-364.6	157.2	2399.4
				J	-1519.6	-349.3	1717.5	-374.5	-328.0	2677.7
			Min	I	-2378.7	-705.2	687.1	-2508.0	-4465.0	-1171.7
				J	-2377.1	-705.2	728.3	-2536.8	-4906.1	-1023.9
1070	2	102	INVSLE Max	I	-1427.3	-236.5	3179.1	338.8	3525.2	7825.4
				J	-1416.9	-236.5	3285.1	317.0	2761.9	8591.9
			Min	I	-4148.1	-1493.6	264.8	-5950.6	-10362.8	-1744.0
				J	-4145.0	-1493.6	341.6	-6042.2	-11482.1	-1532.2
			INVSLE Min	I	309.3	600.7	842.6	-757.2	1334.5	2757.0
				J	311.2	600.7	883.1	-761.1	1052.6	3521.3
			Max	I	-4997.0	-1853.5	287.4	-3144.6	-2579.1	-4695.8

Sovrapasso di ingresso - Ponte strallato - Relazione di calcolo

			J	-4995.1	-1853.5	328.0	-3148.5	-2958.6	-4751.8	
			INVSLE Max	I	-1267.7	-238.6	2266.2	196.3	2076.3	5463.7
				J	-1260.0	-238.6	2344.8	183.9	1393.9	6056.4
			Min	I	-3191.3	-1068.8	653.5	-3977.7	-7274.5	-1466.6
				J	-3188.5	-1068.8	720.9	-4046.5	-7983.6	-1306.9
			INVSLEQP Max	I	-2702.4	-758.6	394.3	-2567.0	-108.0	-749.2
				J	-2700.5	-758.6	434.9	-2570.9	-333.3	-311.3
			Min	I	-2782.7	-774.5	378.4	-2640.7	-204.6	-1066.7
				J	-2780.8	-774.5	419.0	-2644.5	-438.8	-637.8
			INVSLEF Max	I	-1516.1	-366.3	1716.2	-383.0	-305.9	2675.9
				J	-1514.2	-366.3	1778.8	-395.5	-1017.4	3082.4
			Min	I	-2370.9	-728.8	727.1	-2559.2	-4892.3	-1024.1
				J	-2368.6	-728.8	786.0	-2600.5	-5538.1	-806.1
1071	2	102	INVSLE Max	I	-1411.4	-265.7	3282.4	290.5	2823.2	8588.0
				J	-1401.4	-265.7	3404.5	301.6	1920.5	9497.4
			Min	I	-4125.2	-1551.5	339.0	-6077.8	-11446.0	-1535.3
				J	-4121.9	-1551.5	425.3	-6183.4	-12781.5	-1274.6
			INVSLE Min	I	327.9	607.9	889.1	-752.1	1065.4	3514.6
				J	330.0	607.9	935.3	-756.5	760.1	4504.6
			Min	I	-4994.6	-1927.9	317.3	-3183.2	-2910.4	-4754.3
				J	-4992.4	-1927.9	363.5	-3187.6	-3411.8	-4893.8
			INVSLE Max	I	-1255.1	-262.9	2342.6	198.9	1416.3	6052.7
				J	-1247.7	-262.9	2433.0	199.3	606.2	6756.5
			Min	I	-3176.2	-1111.6	719.0	-4105.8	-7953.9	-1306.4
				J	-3173.1	-1111.6	794.9	-4185.2	-8886.1	-1114.2
			INVSLEQP Max	I	-2689.8	-797.2	432.1	-2576.4	-294.1	-317.8
				J	-2687.7	-797.2	478.4	-2580.9	-577.0	206.7
			Min	I	-2769.9	-814.2	416.1	-2648.9	-400.8	-644.1
				J	-2767.8	-814.2	462.4	-2653.3	-694.0	-130.5
			INVSLEF Max	I	-1509.0	-390.7	1776.9	-416.2	-985.0	3080.0
				J	-1506.9	-390.7	1848.7	-415.8	-1828.2	3565.3
			Min	I	-2359.3	-762.7	784.2	-2643.7	-5516.8	-806.1
				J	-2356.8	-762.7	851.0	-2691.1	-6286.8	-546.8
1072	2	102	INVSLE Max	I	-1395.2	-297.3	3401.5	253.9	1989.5	9493.5
				J	-1387.2	-297.3	3522.7	265.7	1095.1	10442.5
			Min	I	-4099.4	-1614.4	422.4	-6241.4	-12737.9	-1278.0
				J	-4096.4	-1614.4	506.5	-6349.4	-14138.4	-996.7
			INVSLE Min	I	347.5	615.1	941.1	-751.0	779.3	4496.3
				J	349.6	615.1	987.3	-755.5	477.8	5592.4
			Min	I	-4990.1	-2008.0	352.5	-3233.5	-3362.7	-4895.8
				J	-4988.0	-2008.0	398.6	-3237.9	-3922.6	-5095.7
			INVSLE Max	I	-1242.1	-289.2	2430.6	204.0	632.3	6752.6
				J	-1236.2	-289.2	2520.3	204.2	-220.7	7487.4
			Min	I	-3159.0	-1158.1	792.8	-4268.8	-8850.7	-1113.0
				J	-3156.2	-1158.1	861.8	-4350.0	-9831.0	-908.1
			INVSLEQP Max	I	-2675.4	-839.0	475.3	-2591.3	-533.4	199.5
				J	-2673.4	-839.0	521.5	-2595.8	-843.6	750.9
			Min	I	-2755.2	-857.2	459.2	-2662.3	-651.6	-137.5
				J	-2753.2	-857.2	505.4	-2666.7	-972.1	402.2
			INVSLEF Max	I	-1500.9	-417.0	1846.6	-450.6	-1790.6	3562.8
				J	-1498.8	-417.0	1917.8	-450.3	-2676.3	4072.0
			Min	I	-2346.1	-799.4	849.0	-2752.5	-6261.4	-546.2
				J	-2343.7	-799.4	914.7	-2800.8	-7069.2	-273.4
1073	2	102	INVSLE Max	I	-1691.8	-222.8	3569.1	351.7	1260.5	12277.9
				J	-1689.2	-222.8	3692.5	358.3	745.4	13224.3
			Min	I	-4505.7	-1642.2	526.9	-6195.7	-13867.5	-519.5
				J	-4501.6	-1642.2	609.1	-6300.4	-15361.5	-270.2
			INVSLE Min	I	247.9	661.5	1018.9	-692.4	558.1	5738.9
				J	249.9	661.5	1065.0	-696.8	218.3	6875.9
			Min	I	-5067.9	-2048.8	408.4	-3185.7	-3792.6	-4487.7
				J	-5066.0	-2048.8	454.6	-3190.1	-4400.2	-4732.4
			INVSLE Max	I	-1438.1	-239.2	2553.6	262.4	-76.8	8735.8
				J	-1436.1	-239.2	2644.9	259.8	-976.7	9468.9
			Min	I	-3479.7	-1160.1	885.8	-4248.2	-9635.7	45.0
				J	-3476.7	-1160.1	950.7	-4327.0	-10684.5	219.1
			INVSLEQP Max	I	-2711.7	-842.5	540.1	-2539.9	-744.9	875.1
				J	-2709.7	-842.5	586.3	-2544.4	-1096.6	1427.0
			Min	I	-2786.4	-858.1	524.0	-2612.4	-873.3	548.7
				J	-2784.5	-858.1	570.2	-2616.8	-1235.4	1090.6
			INVSLEF Max	I	-1684.0	-393.3	1948.4	-385.0	-2499.0	5097.3
				J	-1682.0	-393.3	2020.5	-387.5	-3432.6	5594.9
			Min	I	-2587.5	-782.3	939.9	-2711.0	-6918.4	642.8
				J	-2585.1	-782.3	1004.8	-2757.5	-7782.5	910.6
1074	2	102	INVSLE Max	I	-1676.0	-298.9	3685.9	178.6	796.6	13217.3
				J	-1672.1	-298.9	3809.2	183.1	330.4	14256.4
			Min	I	-4463.5	-1775.8	603.3	-6492.5	-15256.8	-276.3
				J	-4459.7	-1775.8	685.0	-6601.8	-16835.7	19.4
			INVSLE Min	I	264.0	645.5	1065.3	-705.4	259.0	6854.4
				J	265.8	645.5	1111.7	-709.9	-103.1	8119.8
			Min	I	-5036.7	-2185.8	443.7	-3315.1	-4295.6	-4731.2

Sovrapasso di ingresso - Ponte strallato - Relazione di calcolo

			J	-5034.8	-2185.8	490.2	-3319.5	-4939.0	-5000.5	
			INVSLEP Max	I	-1424.2	-300.7	2639.6	218.7	-924.0	9461.7
				J	-1421.3	-300.7	2731.0	214.3	-1880.3	10267.0
			Min	I	-3446.3	-1262.7	946.5	-4571.6	-10601.2	221.8
				J	-3443.5	-1262.7	1011.4	-4653.7	-11712.3	433.0
			INVSLEQP Max	I	-2682.9	-928.1	580.3	-2584.2	-1005.5	1412.1
				J	-2681.0	-928.1	626.7	-2588.6	-1385.1	2023.9
			Min	I	-2757.1	-946.1	564.0	-2652.8	-1146.8	1076.2
				J	-2755.2	-946.1	610.4	-2657.2	-1536.9	1676.4
			INVSLEF Max	I	-1669.2	-453.7	2015.9	-510.5	-3354.7	5590.6
				J	-1667.3	-453.7	2087.8	-514.9	-4344.5	6144.5
			Min	I	-2562.2	-863.9	1000.7	-2940.6	-7722.0	911.4
				J	-2560.0	-863.9	1065.6	-2989.2	-8623.0	1218.2
1075	2	102	INVSLEP Max	I	-1672.8	-295.1	3809.5	194.5	327.8	14256.8
				J	-1664.5	-295.1	3917.1	201.8	-101.7	15155.9
			Min	I	-4461.7	-1769.1	685.3	-6589.9	-16841.7	19.7
				J	-4458.6	-1769.1	753.8	-6689.3	-18287.3	274.5
			INVSLEF Max	I	285.3	669.6	1119.7	-708.7	-106.3	8123.3
				J	286.9	669.6	1160.0	-712.6	-438.5	9257.0
			Min	I	-5056.6	-2202.2	482.8	-3312.4	-4943.4	-5003.0
				J	-5054.9	-2202.2	523.1	-3316.3	-5533.5	-5275.9
			INVSLEP Max	I	-1421.9	-297.6	2731.3	217.8	-1883.2	10267.3
				J	-1415.7	-297.6	2810.9	215.6	-2727.0	10964.1
			Min	I	-3445.1	-1257.5	1011.7	-4639.2	-11717.0	432.9
				J	-3442.8	-1257.5	1066.9	-4713.8	-12737.1	614.3
			INVSLEQP Max	I	-2682.4	-923.9	627.0	-2586.0	-1389.8	2024.7
				J	-2680.8	-923.9	667.3	-2589.9	-1744.1	2553.6
			Min	I	-2756.6	-941.7	610.7	-2654.8	-1541.5	1677.2
				J	-2755.0	-941.7	651.0	-2658.7	-1904.9	2196.1
			INVSLEF Max	I	-1668.0	-450.7	2088.1	-507.2	-4348.7	6144.7
				J	-1666.3	-450.7	2150.6	-509.4	-5221.6	6623.6
			Min	I	-2561.2	-859.8	1065.8	-2978.3	-8626.7	1218.1
				J	-2559.3	-859.8	1121.0	-3022.5	-9460.8	1479.4
1076	2	103	INVSLEP Max	I	-1660.4	-317.4	3915.1	121.7	-85.9	15154.4
				J	-1653.7	-317.4	3989.5	123.4	-407.5	15815.9
			Min	I	-4446.7	-1808.4	752.1	-6771.2	-18242.2	272.8
				J	-4444.7	-1808.4	791.3	-6847.0	-19344.5	464.1
			INVSLEF Max	I	300.0	675.3	1162.7	-722.4	-426.6	9251.2
				J	301.1	675.3	1190.9	-725.2	-675.1	10095.7
			Min	I	-5054.4	-2252.9	517.2	-3364.1	-5500.1	-5275.9
				J	-5053.3	-2252.9	545.4	-3366.9	-5940.3	-5484.3
			INVSLEP Max	I	-1412.1	-315.6	2809.4	187.0	-2710.8	10962.3
				J	-1407.1	-315.6	2864.5	183.2	-3334.4	11475.0
			Min	I	-3433.2	-1287.7	1065.6	-4810.7	-12702.1	615.3
				J	-3431.8	-1287.7	1104.2	-4867.5	-13482.1	752.1
			INVSLEQP Max	I	-2672.4	-949.0	665.5	-2608.8	-1716.1	2549.2
				J	-2671.3	-949.0	693.7	-2611.5	-1983.5	2939.3
			Min	I	-2746.5	-967.5	649.2	-2676.3	-1877.6	2191.8
				J	-2745.3	-967.5	677.4	-2679.1	-2151.6	2574.5
			INVSLEF Max	I	-1662.3	-468.4	2149.3	-562.9	-5197.5	6622.6
				J	-1661.2	-468.4	2192.3	-566.6	-5841.9	6976.2
			Min	I	-2552.1	-883.8	1119.8	-3095.6	-9438.1	1479.4
				J	-2550.9	-883.8	1158.4	-3129.6	-10056.7	1671.2
1077	2	103	INVSLEP Max	I	-1653.5	-317.4	3995.3	125.9	-407.5	15815.9
				J	-1644.4	-317.4	4071.4	128.4	-742.1	16477.5
			Min	I	-4444.5	-1808.4	795.5	-6845.2	-19344.5	464.0
				J	-4442.7	-1808.4	823.7	-6921.2	-20484.2	655.3
			INVSLEF Max	I	315.6	691.6	1199.8	-723.3	-675.9	10097.3
				J	316.7	691.6	1228.0	-726.0	-934.5	10955.9
			Min	I	-5067.4	-2269.2	545.0	-3365.2	-5939.5	-5486.0
				J	-5066.3	-2269.2	573.3	-3368.0	-6395.6	-5708.4
			INVSLEP Max	I	-1406.9	-315.6	2868.7	185.0	-3334.4	11474.9
				J	-1400.2	-315.6	2925.1	181.6	-3958.0	11987.7
			Min	I	-3431.6	-1287.7	1108.5	-4865.8	-13482.2	752.0
				J	-3430.3	-1287.7	1146.1	-4922.8	-14289.9	886.1
			INVSLEQP Max	I	-2671.1	-949.0	698.0	-2609.8	-1983.5	2939.2
				J	-2670.0	-949.0	726.2	-2612.5	-2264.0	3329.3
			Min	I	-2745.2	-967.5	681.7	-2677.3	-2151.6	2574.4
				J	-2744.0	-967.5	709.9	-2680.1	-2438.7	2957.1
			INVSLEF Max	I	-1661.0	-468.4	2196.6	-564.8	-5841.9	6976.2
				J	-1659.9	-468.4	2240.5	-568.3	-6486.3	7329.8
			Min	I	-2550.7	-883.8	1162.7	-3127.8	-10056.7	1671.1
				J	-2549.5	-883.8	1200.3	-3161.7	-10694.3	1862.9
1078	2	102	INVSLEP Max	I	-1636.9	-356.9	4067.8	-57.5	-711.8	16475.3
				J	-1625.0	-356.9	4173.3	-55.3	-1195.0	17439.5
			Min	I	-4419.5	-1881.7	820.6	-7107.0	-20391.0	652.2
				J	-4417.3	-1881.7	860.9	-7214.6	-22049.9	939.7
			INVSLEF Max	I	327.8	687.2	1227.6	-754.6	-910.6	10942.9
				J	329.4	687.2	1267.9	-758.4	-1284.2	12190.4
			Min	I	-5051.1	-2348.4	567.7	-3471.8	-6331.4	-5706.1

Sovrapasso di ingresso - Ponte strallato - Relazione di calcolo

			J	-5049.5	-2348.4	608.0	-3475.7	-6987.2	-6021.7	
			INVSLE Max	I	-1393.3	-347.6	2922.2	106.2	-3931.9	11984.7
				J	-1384.5	-347.6	3000.3	100.4	-4828.4	12732.0
			Min	I	-3411.8	-1344.0	1143.9	-5135.7	-14218.1	888.9
				J	-3410.2	-1344.0	1197.1	-5216.4	-15396.0	1090.0
			INVSLEQP Max	I	-2653.8	-995.8	722.8	-2657.7	-2210.1	3321.1
				J	-2652.2	-995.8	763.1	-2661.6	-2617.6	3890.8
			Min	I	-2727.5	-1015.6	706.4	-2722.6	-2386.1	2949.1
				J	-2725.9	-1015.6	746.7	-2726.4	-2802.8	3507.8
			INVSLEF Max	I	-1652.0	-501.2	2238.0	-690.8	-6444.9	7328.3
				J	-1650.4	-501.2	2299.1	-696.6	-7370.1	7846.3
			Min	I	-2535.6	-928.5	1198.1	-3323.0	-10647.8	1863.3
				J	-2534.0	-928.5	1251.3	-3370.9	-11572.3	2147.3
1079	2	102	INVSLE Max	I	-1622.5	-369.0	4172.1	-124.0	-1184.9	17438.8
				J	-1612.9	-369.0	4292.8	-107.8	-1753.5	18558.3
			Min	I	-4409.5	-1905.3	859.9	-7282.3	-22015.9	938.7
				J	-4407.0	-1905.3	905.9	-7408.3	-24195.4	1275.1
			INVSLEF Max	I	346.9	701.7	1271.1	-769.9	-1277.0	12187.6
				J	348.7	701.7	1317.1	-774.3	-1724.9	13651.0
			Min	I	-5058.2	-2389.9	602.8	-3512.8	-6964.9	-6022.3
				J	-5056.5	-2389.9	648.8	-3517.2	-7747.0	-6403.9
			INVSLEQP Max	I	-1382.2	-357.4	2999.4	70.9	-4820.4	12731.1
				J	-1375.1	-357.4	3088.8	71.5	-5762.2	13598.6
			Min	I	-3404.0	-1362.2	1196.3	-5292.7	-15370.0	1091.0
				J	-3402.1	-1362.2	1250.7	-5387.2	-16926.3	1326.6
			INVSLEQP Max	I	-2646.8	-1010.9	762.0	-2678.5	-2599.8	3888.1
				J	-2645.1	-1010.9	808.0	-2682.9	-3092.1	4548.8
			Min	I	-2720.4	-1031.1	745.5	-2742.5	-2785.3	3505.2
				J	-2718.6	-1031.1	791.6	-2746.9	-3288.3	4153.0
			INVSLEF Max	I	-1647.8	-511.8	2298.3	-741.6	-7357.0	7845.9
				J	-1646.0	-511.8	2368.0	-741.0	-8331.5	8447.7
			Min	I	-2529.3	-943.0	1250.6	-3428.8	-11555.3	2147.4
				J	-2527.5	-943.0	1304.9	-3484.6	-12764.8	2478.2
1080	2	102	INVSLE Max	I	-1602.4	-418.9	4287.9	-434.9	-1713.2	18555.2
				J	-1597.8	-418.9	4406.5	-423.4	-2310.2	19747.7
			Min	I	-4373.2	-2003.2	901.7	-7725.4	-24003.5	1271.0
				J	-4370.9	-2003.2	948.1	-7858.7	-26364.6	1642.8
			INVSLEF Max	I	363.3	695.8	1314.9	-834.0	-1690.3	13632.0
				J	365.0	695.8	1361.3	-838.5	-2163.9	15182.9
			Min	I	-5033.0	-2495.5	642.9	-3688.2	-7653.8	-6399.4
				J	-5031.2	-2495.5	689.3	-3692.6	-8473.8	-6788.3
			INVSLEQP Max	I	-1365.4	-398.1	3084.9	-76.5	-5728.5	13594.5
				J	-1362.1	-398.1	3172.7	-78.8	-6665.2	14518.7
			Min	I	-3375.3	-1437.4	1247.6	-5739.2	-16780.9	1330.6
				J	-3373.5	-1437.4	1299.9	-5839.1	-18471.2	1595.3
			INVSLEQP Max	I	-2621.8	-1073.3	803.4	-2765.1	-3015.9	4537.4
				J	-2620.1	-1073.3	849.8	-2769.5	-3538.7	5244.5
			Min	I	-2694.8	-1095.2	786.8	-2825.0	-3213.6	4142.0
				J	-2693.1	-1095.2	833.2	-2829.5	-3747.1	4835.0
			INVSLEF Max	I	-1634.5	-555.5	2364.6	-953.9	-8275.6	8445.8
				J	-1632.8	-555.5	2433.0	-956.3	-9207.0	9091.4
			Min	I	-2507.4	-1002.7	1301.9	-3753.1	-12666.8	2478.9
				J	-2505.7	-1002.7	1352.8	-3812.3	-13973.2	2838.6
1081	2	102	INVSLE Max	I	-1518.8	1956.5	-936.2	7784.9	-2280.3	16739.2
				J	-1520.3	1956.5	-889.8	7651.3	-1691.1	15583.7
			Min	I	-4639.5	328.0	-4384.5	411.2	-26095.4	1120.2
				J	-4636.4	328.0	-4265.1	423.8	-23815.9	747.5
			INVSLEF Max	I	239.0	2420.4	-673.2	3521.7	-2068.9	13891.0
				J	240.6	2420.4	-626.8	3517.2	-1603.4	12391.1
			Min	I	-5022.8	-620.0	-1353.0	861.8	-8509.6	-6713.2
				J	-5021.2	-620.0	-1306.7	857.3	-7697.3	-6375.0
			INVSLEQP Max	I	-1291.2	1402.2	-1289.5	5805.7	-6686.8	12267.2
				J	-1292.3	1402.2	-1236.7	5705.6	-5747.5	11370.0
			Min	I	-3562.8	331.0	-3156.0	50.2	-18276.0	1108.5
				J	-3560.5	331.0	-3067.6	48.4	-16646.1	867.5
			INVSLEQP Max	I	-2654.9	1094.3	-820.2	2721.3	-3502.4	4517.6
				J	-2653.3	1094.3	-773.8	2716.9	-2988.0	3811.5
			Min	I	-2724.2	1071.1	-837.1	2669.5	-3712.5	4121.5
				J	-2722.6	1071.1	-790.7	2665.0	-3187.2	3430.4
			INVSLEF Max	I	-1729.9	979.6	-1342.0	3777.1	-9192.0	7408.9
				J	-1728.3	979.6	-1290.6	3717.8	-8245.8	6780.3
			Min	I	-2663.4	554.7	-2419.7	932.8	-13860.8	2326.9
				J	-2661.5	554.7	-2350.8	931.1	-12597.7	1969.1
1082	2	102	INVSLE Max	I	-1529.4	1855.8	-892.3	7338.9	-1724.2	15625.1
				J	-1532.2	1855.8	-846.3	7212.8	-1167.4	14542.8
			Min	I	-4669.4	286.5	-4268.7	99.1	-23948.5	760.4
				J	-4666.4	286.5	-4147.2	116.6	-22008.1	423.1
			INVSLEF Max	I	223.4	2312.7	-632.9	3349.3	-1638.1	12420.1
				J	224.9	2312.7	-586.9	3344.9	-1198.4	11009.0
			Min	I	-5042.3	-623.1	-1305.7	798.1	-7778.9	-6372.3

Sovrapasso di ingresso - Ponte strallato - Relazione di calcolo

			J	-5040.7	-623.1	-1259.7	793.7	-7006.3	-6043.1	
			INVSLE Max	I	-1300.9	1324.8	-1238.6	5358.0	-5777.4	11400.8
				J	-1303.0	1324.8	-1183.8	5263.5	-4827.8	10560.3
			Min	I	-3586.9	296.7	-3070.4	-98.6	-16747.6	879.6
				J	-3584.6	296.7	-2980.4	-97.2	-15368.3	661.1
			INVSLEQP Max	I	-2676.6	1030.9	-776.7	2641.1	-3056.5	3828.8
				J	-2675.1	1030.9	-730.7	2636.7	-2573.7	3168.6
			Min	I	-2746.5	1009.3	-793.5	2585.1	-3254.9	3447.6
				J	-2745.0	1009.3	-747.5	2580.7	-2761.4	2801.2
			INVSLEF Max	I	-1739.8	918.7	-1292.6	3452.2	-8297.0	6803.0
				J	-1738.2	918.7	-1237.8	3396.3	-7317.8	6218.3
			Min	I	-2681.2	513.8	-2353.1	720.3	-12664.2	1983.3
				J	-2679.4	513.8	-2282.9	721.7	-11585.4	1654.4
1083	2	102	INVSLE Max	I	-1534.3	1831.4	-846.9	7146.3	-1175.2	14552.0
				J	-1537.3	1831.4	-806.6	7038.8	-704.8	13618.3
			Min	I	-4674.0	276.4	-4148.1	48.6	-22037.2	426.0
				J	-4671.3	276.4	-4041.9	52.0	-20410.1	137.6
			INVSLE Min	I	206.3	2271.3	-592.2	3307.7	-1205.4	11013.7
				J	207.7	2271.3	-551.9	3303.9	-838.7	9812.6
			Min	I	-5030.9	-608.5	-1255.7	783.0	-7026.4	-6040.6
				J	-5029.6	-608.5	-1215.4	779.1	-6379.7	-5771.5
			INVSLE Max	I	-1305.0	1306.1	-1184.3	5188.3	-4835.0	10567.2
				J	-1307.2	1306.1	-1130.6	5107.7	-3941.1	9842.2
			Min	I	-3590.7	288.4	-2981.1	-126.5	-15390.8	663.7
				J	-3588.7	288.4	-2902.4	-131.6	-14236.4	476.9
			INVSLEQP Max	I	-2680.5	1015.6	-731.4	2621.2	-2590.0	3172.6
				J	-2679.2	1015.6	-691.1	2617.3	-2191.2	2603.3
			Min	I	-2750.5	994.4	-748.2	2564.2	-2777.4	2805.1
				J	-2749.2	994.4	-707.9	2560.4	-2369.2	2247.7
			INVSLEF Max	I	-1740.9	904.0	-1238.3	3339.1	-7330.0	6223.4
				J	-1739.6	904.0	-1184.6	3291.3	-6410.2	5719.9
			Min	I	-2684.0	503.9	-2283.5	677.3	-11600.1	1657.5
				J	-2682.4	503.9	-2222.1	672.1	-10691.3	1375.1
1084	2	103	INVSLE Max	I	-1543.5	1755.8	-808.5	6856.4	-733.9	13645.1
				J	-1545.8	1755.8	-780.3	6780.5	-405.1	13004.5
			Min	I	-4694.0	245.2	-4044.8	-132.4	-20493.9	146.0
				J	-4692.1	245.2	-3968.0	-128.9	-19363.9	-46.0
			INVSLE Min	I	194.7	2190.7	-557.3	3201.6	-863.2	9831.8
				J	195.6	2190.7	-529.1	3198.9	-609.5	9007.2
			Min	I	-5043.1	-611.0	-1214.1	751.0	-6437.3	-5769.6
				J	-5042.2	-611.0	-1185.9	748.2	-5988.5	-5581.5
			INVSLE Max	I	-1313.1	1248.1	-1132.1	4897.9	-3964.1	9862.2
				J	-1314.8	1248.1	-1094.1	4840.9	-3342.1	9364.7
			Min	I	-3606.8	262.6	-2904.6	-206.4	-14301.4	484.4
				J	-3605.4	262.6	-2847.8	-209.3	-13500.9	360.3
			INVSLEQP Max	I	-2695.4	968.0	-693.4	2576.2	-2240.8	2615.0
				J	-2694.5	968.0	-665.2	2573.4	-1967.0	2225.0
			Min	I	-2765.7	948.0	-710.1	2516.5	-2418.1	2259.3
				J	-2764.8	948.0	-681.9	2513.8	-2137.6	1877.4
			INVSLEF Max	I	-1747.4	858.3	-1186.2	3131.9	-6447.8	5734.5
				J	-1746.5	858.3	-1148.3	3098.0	-5807.1	5391.2
			Min	I	-2695.9	473.4	-2223.9	550.9	-10733.7	1384.1
				J	-2694.9	473.4	-2179.6	548.0	-10100.1	1193.4
1085	2	103	INVSLE Max	I	-1545.6	1755.8	-776.1	6782.3	-405.2	13004.4
				J	-1547.9	1755.8	-732.9	6706.8	-89.5	12363.9
			Min	I	-4691.9	245.2	-3962.3	-126.5	-19364.0	-46.1
				J	-4690.0	245.2	-3887.4	-123.8	-18271.6	-238.0
			INVSLE Min	I	181.0	2175.0	-529.2	3199.9	-608.4	9005.2
				J	181.9	2175.0	-501.0	3197.1	-364.6	8194.9
			Min	I	-5027.4	-595.4	-1177.2	750.8	-5989.7	-5579.6
				J	-5026.5	-595.4	-1149.0	748.0	-5557.1	-5405.7
			INVSLE Max	I	-1314.7	1248.1	-1089.8	4842.7	-3342.1	9364.7
				J	-1316.4	1248.1	-1050.9	4786.1	-2721.5	8867.2
			Min	I	-3605.2	262.6	-2843.5	-207.5	-13500.9	360.3
				J	-3603.8	262.6	-2788.1	-210.7	-12728.3	236.0
			INVSLEQP Max	I	-2694.3	968.0	-660.9	2575.2	-1967.0	2225.0
				J	-2693.4	968.0	-632.7	2572.5	-1706.4	1834.9
			Min	I	-2764.7	948.0	-677.6	2515.6	-2137.6	1877.3
				J	-2763.8	948.0	-649.4	2512.8	-1870.2	1495.3
			INVSLEF Max	I	-1746.4	858.3	-1144.0	3099.8	-5807.1	5391.1
				J	-1745.5	858.3	-1105.0	3066.0	-5167.8	5047.8
			Min	I	-2694.7	473.4	-2175.3	549.8	-10100.1	1193.4
				J	-2693.6	473.4	-2132.0	546.6	-9485.6	1002.7
1086	2	102	INVSLE Max	I	-1551.1	1715.1	-734.0	6626.8	-104.8	12377.1
				J	-1554.3	1715.1	-664.5	6527.8	316.2	11508.1
			Min	I	-4701.6	228.4	-3889.0	-203.2	-18312.2	-234.0
				J	-4698.9	228.4	-3780.6	-194.3	-16881.5	-489.9
			INVSLE Min	I	167.7	2124.0	-506.5	3149.6	-376.9	8203.4
				J	169.0	2124.0	-466.1	3145.7	-50.9	7118.3
			Min	I	-5025.8	-589.1	-1145.8	738.7	-5587.7	-5403.7

Sovrapasso di ingresso - Ponte strallato - Relazione di calcolo

			J	-5024.6	-589.1	-1105.4	734.9	-5009.0	-5179.9		
		INVSLEP	Max	I	-1319.4	1216.9	-1051.7	4690.8	-2735.8	8877.1	
				J	-1321.8	1216.9	-996.0	4616.5	-1896.5	8202.2	
			Min	I	-3613.1	248.7	-2789.3	-239.1	-12760.1	239.6	
				J	-3611.1	248.7	-2709.1	-240.3	-11751.1	74.2	
		INVSLEQP	Max	I	-2701.8	942.4	-634.0	2555.5	-1732.6	1840.9	
				J	-2700.5	942.4	-593.6	2551.6	-1388.1	1312.1	
			Min	I	-2772.3	923.1	-650.6	2494.5	-1896.1	1501.2	
				J	-2771.1	923.1	-610.3	2490.6	-1542.2	983.3	
		INVSLEF	Max	I	-1749.5	833.8	-1105.9	2993.9	-5189.6	5055.0	
				J	-1748.2	833.8	-1050.2	2949.9	-4324.1	4590.8	
			Min	I	-2700.6	456.9	-2133.0	493.8	-9506.4	1007.0	
				J	-2699.0	456.9	-2070.0	492.5	-8678.3	750.7	
1087	2	102	INVSLEP	Max	I	-1553.8	1722.1	-664.3	6539.5	318.8	11506.0
				J	-1557.5	1722.1	-581.3	6430.7	775.4	10501.2	
			Min	I	-4697.0	231.3	-3780.4	-183.0	-16876.3	-490.5	
				J	-4693.9	231.3	-3656.2	-176.7	-15315.2	-787.4	
		INVSLEF	Max	I	149.1	2108.7	-472.8	3151.9	-47.2	7114.0	
				J	150.5	2108.7	-426.4	3147.4	308.4	5905.8	
			Min	I	-5002.4	-566.2	-1098.4	736.9	-5005.5	-5177.3	
				J	-5000.9	-566.2	-1051.9	732.4	-4375.7	-4965.7	
		INVSLEP	Max	I	-1321.3	1222.2	-995.8	4630.8	-1893.7	8200.6	
				J	-1324.1	1222.2	-930.3	4549.1	-942.0	7420.3	
			Min	I	-3609.6	251.0	-2708.8	-236.9	-11747.0	73.6	
				J	-3607.3	251.0	-2616.9	-240.2	-10649.1	-130.6	
		INVSLEQP	Max	I	-2699.1	946.7	-593.4	2553.9	-1383.6	1311.1	
				J	-2697.7	946.7	-547.0	2549.5	-1015.1	699.4	
			Min	I	-2769.6	927.3	-610.1	2493.1	-1537.8	982.3	
				J	-2768.2	927.3	-563.7	2488.7	-1158.5	383.1	
		INVSLEF	Max	I	-1747.6	838.0	-1050.0	2960.6	-4320.0	4589.6	
				J	-1746.1	838.0	-984.5	2912.3	-3338.2	4052.6	
			Min	I	-2697.9	459.7	-2069.8	500.1	-8674.9	750.0	
				J	-2696.1	459.7	-1997.4	496.8	-7781.3	453.0	
1088	2	102	INVSLEP	Max	I	-1567.6	1583.7	-585.1	6245.1	723.9	10540.5
				J	-1571.4	1583.7	-501.7	6141.1	1290.9	9630.6	
			Min	I	-4730.6	173.9	-3661.8	-355.3	-15405.7	-775.2	
				J	-4727.8	173.9	-3537.6	-346.9	-13928.9	-1026.0	
		INVSLEF	Max	I	133.5	1969.2	-436.3	3024.0	264.7	5934.8	
				J	134.9	1969.2	-390.1	3019.5	597.9	4855.7	
			Min	I	-5027.3	-578.7	-1049.8	724.0	-4473.5	-4962.4	
				J	-5026.0	-578.7	-1003.7	719.5	-3881.3	-4776.6	
		INVSLEP	Max	I	-1333.7	1116.0	-933.2	4309.9	-992.8	7449.9	
				J	-1336.6	1116.0	-867.8	4231.6	-98.9	6743.1	
			Min	I	-3636.8	203.6	-2621.2	-281.0	-10722.4	-119.5	
				J	-3634.6	203.6	-2529.2	-282.4	-9686.6	-316.5	
		INVSLEQP	Max	I	-2724.5	859.6	-551.4	2515.0	-1102.8	718.2	
				J	-2723.1	859.6	-505.2	2510.6	-763.3	165.9	
			Min	I	-2795.6	842.5	-567.9	2450.3	-1244.8	401.6	
				J	-2794.2	842.5	-521.8	2445.9	-894.7	-139.7	
		INVSLEF	Max	I	-1758.8	754.6	-987.6	2732.2	-3413.2	4073.9	
				J	-1757.5	754.6	-922.1	2686.0	-2488.9	3593.9	
			Min	I	-2718.2	403.9	-2001.0	375.2	-7836.8	465.6	
				J	-2716.6	403.9	-1928.4	373.8	-6980.3	206.1	
1089	2	102	INVSLEP	Max	I	-1293.4	1561.9	-482.5	6292.2	1074.8	7819.6
				J	-1297.3	1561.9	-397.2	6184.7	2014.6	6911.9	
			Min	I	-4274.8	236.0	-3494.7	-257.4	-14194.8	-1485.8	
				J	-4272.7	236.0	-3372.9	-244.2	-12807.4	-1768.6	
		INVSLEF	Max	I	230.4	1931.8	-380.5	3066.8	517.6	4730.3	
				J	231.6	1931.8	-334.4	3062.3	812.1	3696.3	
			Min	I	-4944.9	-534.9	-973.2	786.5	-4003.4	-5376.5	
				J	-4943.7	-534.9	-927.1	782.1	-3457.6	-5239.8	
		INVSLEP	Max	I	-1154.7	1118.7	-845.2	4323.0	-239.0	5513.8	
				J	-1157.6	1118.7	-773.3	4242.3	607.1	4809.0	
			Min	I	-3312.8	244.4	-2498.5	-221.4	-9877.8	-1230.5	
				J	-3310.9	244.4	-2408.3	-220.2	-8907.6	-1478.2	
		INVSLEQP	Max	I	-2687.3	859.2	-487.0	2565.9	-857.1	56.6	
				J	-2686.1	859.2	-440.8	2561.4	-559.0	-495.4	
			Min	I	-2763.6	839.4	-503.5	2502.5	-988.9	-271.6	
				J	-2762.4	839.4	-457.3	2498.0	-680.2	-810.9	
		INVSLEF	Max	I	-1573.9	774.3	-898.3	2772.8	-2661.6	2591.8	
				J	-1572.6	774.3	-832.0	2724.8	-1785.3	2101.9	
			Min	I	-2473.7	425.1	-1899.8	435.5	-7127.6	-618.4	
				J	-2472.3	425.1	-1828.2	436.7	-6326.7	-934.1	
1090	2	102	INVSLEP	Max	I	-1301.9	1496.8	-399.1	6130.8	1945.2	6928.0
				J	-1305.9	1496.8	-311.6	6025.7	2832.9	6062.1	
			Min	I	-4294.7	212.9	-3375.2	-292.2	-12847.2	-1763.2	
				J	-4292.6	212.9	-3252.5	-286.0	-11524.2	-2025.5	
		INVSLEF	Max	I	212.5	1851.2	-343.9	3016.6	791.1	3706.8	
				J	213.7	1851.2	-297.7	3012.2	1064.4	2778.7	
			Min	I	-4944.4	-526.9	-921.2	787.8	-3505.7	-5236.3	

Sovrapasso di ingresso - Ponte strallato - Relazione di calcolo

			J	-4943.2	-526.9	-875.0	783.3	-2994.6	-5160.1	
			INVSLE Max	I	-1162.0	1070.5	-774.7	4161.9	580.1	4821.2
				J	-1165.0	1070.5	-697.9	4082.9	1381.9	4149.0
			Min	I	-3324.7	224.4	-2410.1	-215.6	-8940.3	-1472.8
				J	-3322.9	224.4	-2319.2	-214.3	-8017.9	-1719.0
			INVSLEQP Max	I	-2698.4	816.5	-442.9	2553.0	-602.2	-486.9
				J	-2697.2	816.5	-396.7	2548.5	-332.1	-1012.2
			Min	I	-2775.0	797.9	-459.4	2488.0	-722.6	-802.6
				J	-2773.8	797.9	-413.2	2483.5	-441.9	-1315.9
			INVSLEF Max	I	-1578.6	736.7	-833.4	2664.9	-1823.3	2110.7
				J	-1577.4	736.7	-766.0	2617.8	-991.0	1645.6
			Min	I	-2482.7	400.4	-1829.8	402.2	-6351.4	-928.0
				J	-2481.2	400.4	-1757.5	403.6	-5587.5	-1241.5
1091	2	102	INVSLE Max	I	-1310.0	1436.7	-313.3	5993.5	2771.0	6075.6
				J	-1313.6	1436.7	-235.4	5902.6	3518.4	5353.3
			Min	I	-4312.0	191.5	-3254.6	-316.6	-11557.3	-2020.9
				J	-4310.2	191.5	-3148.0	-337.7	-10448.7	-2234.1
			INVSLE Min	I	195.5	1776.4	-307.0	2977.4	1044.9	2787.2
				J	196.5	1776.4	-266.5	2973.5	1319.5	2073.5
			Min	I	-4942.4	-519.1	-869.2	792.3	-3037.7	-5156.4
				J	-4941.4	-519.1	-828.6	788.4	-2671.2	-5152.3
			INVSLE Max	I	-1168.8	1026.0	-699.2	4026.4	1358.6	4159.4
				J	-1171.5	1026.0	-631.0	3958.0	2032.4	3598.8
			Min	I	-3335.0	206.0	-2320.9	-201.7	-8045.5	-1714.5
				J	-3333.4	206.0	-2241.9	-215.2	-7323.8	-1919.2
			INVSLEQP Max	I	-2707.9	777.2	-398.7	2544.5	-371.5	-1004.9
				J	-2706.9	777.2	-358.2	2540.6	-157.8	-1443.5
			Min	I	-2784.8	759.7	-415.2	2478.2	-480.6	-1308.7
				J	-2783.8	759.7	-374.6	2474.3	-257.6	-1737.5
			INVSLEF Max	I	-1582.6	702.0	-767.3	2575.9	-1024.0	1653.1
				J	-1581.6	702.0	-707.8	2535.0	-323.2	1266.5
			Min	I	-2490.3	377.7	-1759.0	380.7	-5608.5	-1236.4
				J	-2489.1	377.7	-1696.0	367.2	-4968.1	-1499.6
1092	2	103	INVSLE Max	I	-1316.3	1394.7	-236.7	5890.0	3475.0	5362.1
				J	-1318.9	1394.7	-181.7	5826.6	3981.1	4868.4
			Min	I	-4323.2	176.6	-3149.5	-349.2	-10469.9	-2231.1
				J	-4322.0	176.6	-3075.1	-379.0	-9712.2	-2373.8
			INVSLE Min	I	181.8	1722.2	-274.0	2953.6	1309.0	2078.6
				J	182.5	1722.2	-246.0	2950.8	1495.1	1635.1
			Min	I	-4938.3	-511.6	-823.5	796.7	-2703.7	-5149.4
				J	-4937.6	-511.6	-795.5	793.9	-2461.9	-5190.1
			INVSLE Max	I	-1174.1	994.9	-631.9	3928.5	2016.2	3605.6
				J	-1176.0	994.9	-584.0	3880.8	2474.2	3222.5
			Min	I	-3341.5	193.1	-2243.2	-199.5	-7344.0	-1916.3
				J	-3340.4	193.1	-2188.0	-213.8	-6887.5	-2056.0
			INVSLEQP Max	I	-2714.1	749.7	-359.6	2539.8	-185.1	-1438.6
				J	-2713.4	749.7	-331.6	2537.0	-46.8	-1738.4
			Min	I	-2791.1	732.9	-376.0	2472.7	-284.4	-1732.6
				J	-2790.4	732.9	-348.0	2469.9	-139.6	-2025.8
			INVSLEF Max	I	-1585.1	677.7	-708.8	2513.4	-345.9	1271.3
				J	-1584.4	677.7	-667.2	2484.8	131.2	1008.0
			Min	I	-2495.2	361.8	-1697.0	358.5	-4981.9	-1496.3
				J	-2494.3	361.8	-1653.1	344.2	-4544.5	-1677.0
1093	2	103	INVSLE Max	I	-1318.7	1394.7	-177.4	5828.4	3981.1	4868.4
				J	-1321.3	1394.7	-121.7	5765.6	4476.7	4376.2
			Min	I	-4321.9	176.6	-3069.4	-376.6	-9712.3	-2373.9
				J	-4320.7	176.6	-2995.4	-412.5	-8979.9	-2666.6
			INVSLE Min	I	167.7	1705.8	-248.3	2953.0	1497.7	1634.0
				J	168.4	1705.8	-220.3	2950.3	1673.7	1240.2
			Min	I	-4922.7	-495.2	-784.7	795.3	-2464.5	-5189.1
				J	-4922.0	-495.2	-756.7	792.5	-2238.5	-5279.5
			INVSLE Max	I	-1175.9	994.9	-579.7	3882.6	2474.2	3222.5
				J	-1177.8	994.9	-531.2	3835.3	2920.4	2840.5
			Min	I	-3340.3	193.1	-2183.8	-212.0	-6887.5	-2056.0
				J	-3339.2	193.1	-2129.0	-232.4	-6446.2	-2196.1
			INVSLEQP Max	I	-2713.3	749.7	-327.4	2538.8	-46.8	-1738.5
				J	-2712.6	749.7	-299.3	2536.0	78.5	-2038.4
			Min	I	-2790.3	732.9	-343.7	2471.7	-139.6	-2025.8
				J	-2789.6	732.9	-315.7	2468.9	-7.7	-2319.0
			INVSLEF Max	I	-1584.3	677.7	-662.9	2486.6	131.2	1007.9
				J	-1583.6	677.7	-621.1	2458.2	596.5	745.1
			Min	I	-2494.2	361.8	-1648.8	346.0	-4544.5	-1677.1
				J	-2493.4	361.8	-1605.1	325.7	-4122.4	-1858.3
1094	2	102	INVSLE Max	I	-1325.6	1324.8	-123.9	5766.3	4403.8	4389.6
				J	-1329.3	1324.8	-43.4	5675.5	5055.0	3785.7
			Min	I	-4341.5	151.6	-2998.0	-443.3	-9012.0	-2659.3
				J	-4339.8	151.6	-2892.1	-493.4	-8011.3	-3095.0
			INVSLE Min	I	154.3	1627.1	-228.3	2926.3	1653.7	1247.7
				J	155.3	1627.1	-187.6	2922.4	1887.9	801.5
			Min	I	-4926.2	-494.2	-752.8	810.7	-2289.2	-5274.4

Sovrappasso di ingresso - Ponte strallato - Relazione di calcolo

			J	-4925.2	-494.2	-712.1	806.7	-1990.6	-5469.8		
		INVSLEP	Max	I	-1181.9	943.2	-532.8	3808.4	2893.5	2850.8	
				J	-1184.6	943.2	-462.6	3740.1	3489.0	2379.9	
			Min	I	-3351.9	171.5	-2131.1	-211.1	-6477.8	-2192.4	
				J	-3350.5	171.5	-2052.6	-239.4	-5874.9	-2383.4	
		INVSLEQP	Max	I	-2724.0	703.9	-301.8	2539.0	33.5	-2030.5	
				J	-2723.0	703.9	-261.1	2535.1	192.9	-2429.1	
			Min	I	-2801.3	688.4	-318.1	2470.8	-51.8	-2311.3	
				J	-2800.3	688.4	-277.4	2466.9	116.8	-2701.2	
		INVSLEF	Max	I	-1589.0	637.4	-622.6	2439.4	559.5	752.4	
				J	-1588.1	637.4	-562.1	2398.0	1182.2	428.4	
			Min	I	-2503.0	335.4	-1606.9	307.3	-4143.7	-1853.9	
				J	-2501.8	335.4	-1543.8	279.0	-3568.1	-2096.3	
1095	2	102	INVSLEP	Max	I	-1332.8	1263.1	-45.4	5688.9	4990.1	3795.1
				J	-1337.0	1263.1	47.2	5595.7	5678.0	3236.2	
			Min	I	-4357.1	129.5	-2894.4	-508.6	-8036.9	-3088.8	
				J	-4355.3	129.5	-2773.6	-566.0	-6952.4	-3562.7	
		INVSLEF	Max	I	136.6	1550.8	-197.6	2907.0	1870.6	806.9	
				J	137.6	1550.8	-151.4	2902.6	2113.9	451.2	
			Min	I	-4921.7	-486.8	-705.9	824.3	-2035.1	-5464.6	
				J	-4920.6	-486.8	-659.7	819.9	-1727.1	-5792.9	
		INVSLEP	Max	I	-1188.0	897.4	-464.1	3729.5	3465.1	2387.3	
				J	-1191.1	897.4	-383.6	3659.2	4101.0	1941.8	
			Min	I	-3361.0	152.4	-2054.5	-213.3	-5900.9	-2380.0	
				J	-3359.3	152.4	-1965.0	-245.4	-5248.1	-2641.0	
		INVSLEQP	Max	I	-2732.4	663.4	-263.3	2539.8	153.4	-2422.5	
				J	-2731.4	663.4	-217.1	2535.4	307.8	-2849.0	
			Min	I	-2810.0	649.1	-279.5	2470.7	78.1	-2694.7	
				J	-2809.0	649.1	-233.3	2466.2	243.0	-3112.0	
		INVSLEF	Max	I	-1592.6	601.8	-563.6	2391.4	1149.8	433.9	
				J	-1591.5	601.8	-494.5	2349.6	1816.8	89.9	
			Min	I	-2509.8	312.1	-1545.4	270.5	-3585.7	-2092.7	
				J	-2508.5	312.1	-1473.4	238.4	-2963.9	-2354.3	
1096	2	102	INVSLEP	Max	I	-1336.8	1268.2	47.3	5593.5	5683.5	3235.4
				J	-1341.0	1268.2	141.1	5502.3	6339.0	2674.9	
			Min	I	-4353.9	131.4	-2773.4	-566.0	-6950.4	-3563.2	
				J	-4352.1	131.4	-2653.7	-629.5	-5913.3	-4070.6	
		INVSLEF	Max	I	116.0	1531.1	-161.1	2905.3	2118.9	451.1	
				J	117.0	1531.1	-114.5	2900.8	2338.9	226.5	
			Min	I	-4897.7	-461.3	-649.7	816.3	-1727.1	-5793.7	
				J	-4896.7	-461.3	-603.1	811.9	-1451.9	-6262.0	
		INVSLEP	Max	I	-1190.9	901.2	-383.5	3659.0	4103.0	1941.2	
				J	-1194.0	901.2	-302.0	3590.2	4710.7	1494.1	
			Min	I	-3358.5	154.0	-1964.8	-248.3	-5246.0	-2641.3	
				J	-3356.9	154.0	-1876.2	-283.2	-4623.0	-2926.1	
		INVSLEQP	Max	I	-2730.6	666.8	-216.9	2534.8	311.1	-2849.5	
				J	-2729.6	666.8	-170.3	2530.3	436.6	-3281.5	
			Min	I	-2808.2	652.4	-233.1	2465.7	246.2	-3112.5	
				J	-2807.1	652.4	-186.6	2461.3	382.2	-3535.1	
		INVSLEF	Max	I	-1591.2	604.8	-494.4	2349.3	1819.6	89.5	
				J	-1590.1	604.8	-424.8	2308.1	2458.5	-256.7	
			Min	I	-2507.9	314.0	-1473.2	238.4	-2962.5	-2354.5	
				J	-2506.6	314.0	-1401.5	203.5	-2370.8	-2621.9	
1097	2	102	INVSLEP	Max	I	-860.6	761.3	-424.6	3653.4	5848.4	78.1
				J	-864.9	761.3	-344.4	3541.3	6791.2	-162.6	
			Min	I	-3618.4	-17.6	-3111.0	-2531.0	-6195.6	-7070.8	
				J	-3616.9	-17.6	-2998.5	-2548.9	-5116.4	-7366.5	
		INVSLEF	Max	I	391.2	1174.9	-353.3	1103.2	2107.5	-1423.1	
				J	392.0	1174.9	-307.3	1098.8	2537.8	-1429.2	
			Min	I	-4384.7	-658.0	-1125.5	-498.5	-1731.2	-8074.4	
				J	-4383.8	-658.0	-1079.5	-503.0	-1245.0	-8398.8	
		INVSLEP	Max	I	-809.8	537.1	-711.3	2216.1	4432.5	-544.0	
				J	-813.0	537.1	-640.0	2131.9	5214.6	-734.8	
			Min	I	-2701.9	4.5	-2272.0	-1805.8	-4860.1	-5535.5	
				J	-2700.6	4.5	-2188.7	-1819.0	-4152.6	-5726.6	
		INVSLEQP	Max	I	-2242.4	290.8	-712.9	320.6	117.6	-5422.1	
				J	-2241.5	290.8	-666.9	316.1	558.8	-5608.0	
			Min	I	-2321.8	276.8	-725.3	267.2	65.3	-5683.2	
				J	-2320.9	276.8	-679.3	262.8	514.5	-5860.2	
		INVSLEF	Max	I	-1206.1	323.9	-788.6	1031.3	2147.1	-2075.5	
				J	-1205.3	323.9	-725.7	978.3	2951.9	-2243.2	
			Min	I	-1974.9	126.2	-1753.7	-1199.6	-2574.7	-4903.1	
				J	-1973.9	126.2	-1686.8	-1216.0	-1889.9	-5027.6	
1098	2	102	INVSLEP	Max	I	-865.3	706.2	-346.2	3563.8	6751.2	-158.7
				J	-869.7	706.2	-264.6	3453.0	7659.1	-373.6	
			Min	I	-3626.6	-33.1	-3000.4	-2475.3	-5129.3	-7363.1	
				J	-3625.1	-33.1	-2886.7	-2492.9	-4111.0	-7639.8	
		INVSLEF	Max	I	374.5	1100.0	-320.5	1091.3	2539.3	-1428.2	
				J	375.3	1100.0	-274.4	1086.9	2963.7	-1344.8	
			Min	I	-4372.5	-644.1	-1069.9	-466.9	-1268.4	-8396.2	

Sovrappasso di ingresso - Ponte strallato - Relazione di calcolo

			J	-4371.6	-644.1	-1023.8	-471.4	-830.5	-8771.9	
			INVSLE Max	I	-813.4	497.7	-641.2	2138.8	5208.5	-731.8
				J	-816.7	497.7	-568.9	2055.6	5957.4	-901.7
			Min	I	-2705.9	-9.5	-2190.2	-1761.8	-4165.9	-5724.9
				J	-2704.6	-9.5	-2106.0	-1774.9	-3492.8	-5903.7
			INVSLEQP Max	I	-2244.9	255.3	-668.9	329.7	547.6	-5605.9
				J	-2244.0	255.3	-622.8	325.3	961.8	-5769.6
			Min	I	-2324.5	242.6	-681.3	275.9	503.9	-5858.2
				J	-2323.7	242.6	-635.2	271.5	926.1	-6013.7
			INVSLEF Max	I	-1206.6	293.9	-726.9	992.2	2937.1	-2241.1
				J	-1205.8	293.9	-663.4	939.7	3708.9	-2391.9
			Min	I	-1977.4	107.4	-1688.1	-1175.7	-1894.6	-5026.6
				J	-1976.4	107.4	-1620.3	-1191.6	-1244.2	-5139.0
1099	2	102	INVSLE Max	I	-869.9	655.1	-266.3	3485.5	7625.0	-370.6
				J	-873.9	655.1	-193.7	3390.0	8528.0	-537.7
			Min	I	-3633.4	-47.5	-2888.5	-2407.0	-4121.6	-7637.0
				J	-3632.2	-47.5	-2789.5	-2426.2	-3278.7	-7863.9
			INVSLE Min	I	358.5	1030.6	-287.2	1086.2	2964.4	-1344.2
				J	359.2	1030.6	-246.7	1082.4	3329.2	-1216.4
			Min	I	-4359.8	-631.0	-1014.2	-432.1	-851.1	-8769.7
				J	-4359.1	-631.0	-973.7	-436.0	-505.6	-9122.4
			INVSLE Max	I	-817.0	461.3	-570.1	2074.2	5953.2	-899.4
				J	-820.0	461.3	-505.8	2002.4	6585.6	-1031.2
			Min	I	-2709.0	-22.4	-2107.4	-1709.0	-3504.0	-5902.5
				J	-2707.9	-22.4	-2034.1	-1723.2	-2942.3	-6049.2
			INVSLEQP Max	I	-2246.7	222.5	-624.7	343.7	951.6	-5767.9
				J	-2246.0	222.5	-584.2	339.8	1292.1	-5893.2
			Min	I	-2326.5	210.8	-637.0	289.6	916.5	-6012.1
				J	-2325.8	210.8	-596.6	285.7	1264.0	-6130.9
			INVSLEF Max	I	-1206.8	266.2	-664.5	962.9	3697.2	-2390.3
				J	-1206.1	266.2	-608.3	917.5	4349.8	-2508.6
			Min	I	-1979.4	90.0	-1621.5	-1143.3	-1247.9	-5138.4
				J	-1978.5	90.0	-1562.3	-1145.5	-706.5	-5227.1
1100	2	103	INVSLE Max	I	-874.0	623.8	-194.7	3416.4	8514.7	-536.2
				J	-876.9	623.8	-143.2	3347.9	9250.2	-645.6
			Min	I	-3637.0	-56.4	-2790.6	-2364.6	-3284.7	-7862.4
				J	-3636.1	-56.4	-2720.0	-2314.7	-2711.3	-8017.6
			INVSLE Min	I	345.2	983.9	-257.2	1085.0	3329.5	-1215.7
				J	345.6	983.9	-229.0	1082.2	3584.6	-1102.2
			Min	I	-4347.7	-618.8	-965.2	-408.9	-518.0	-9121.6
				J	-4347.3	-618.8	-937.1	-411.7	-292.8	-9381.8
			INVSLE Max	I	-820.1	438.9	-506.5	2020.5	6582.9	-1030.0
				J	-822.2	438.9	-461.0	1969.0	7009.9	-1116.2
			Min	I	-2710.4	-30.4	-2035.0	-1676.4	-2948.7	-6048.5
				J	-2709.6	-30.4	-1982.7	-1639.4	-2564.4	-6148.9
			INVSLEQP Max	I	-2247.5	202.4	-585.4	354.0	1285.9	-5892.3
				J	-2247.0	202.4	-557.2	351.2	1515.7	-5973.7
			Min	I	-2327.4	191.4	-597.7	299.8	1258.1	-6130.1
				J	-2326.9	191.4	-569.5	297.0	1492.9	-6207.0
			INVSLEF Max	I	-1206.6	249.2	-609.0	937.2	4342.7	-2507.8
				J	-1206.2	249.2	-569.5	904.5	4784.2	-2586.0
			Min	I	-1980.1	79.4	-1563.1	-1109.6	-708.6	-5226.9
				J	-1979.5	79.4	-1521.0	-1131.8	-338.7	-5285.9
1101	2	103	INVSLE Max	I	-876.8	623.8	-138.9	3349.7	9250.1	-645.7
				J	-879.7	623.8	-86.7	3281.8	9996.6	-754.0
			Min	I	-3636.1	-56.4	-2714.2	-2312.3	-2711.3	-8017.6
				J	-3635.2	-56.4	-2646.0	-2354.4	-2163.5	-8174.3
			INVSLE Min	I	330.3	966.1	-234.7	1083.4	3586.0	-1100.3
				J	330.8	966.1	-206.5	1080.7	3833.8	-975.3
			Min	I	-4331.8	-601.1	-922.9	-409.3	-294.2	-9383.8
				J	-4331.4	-601.1	-894.7	-412.1	-87.8	-9655.4
			INVSLE Max	I	-822.1	438.9	-456.8	1970.8	7009.9	-1116.3
				J	-824.3	438.9	-410.8	1919.8	7479.8	-1201.7
			Min	I	-2709.5	-30.4	-1978.4	-1637.6	-2564.4	-6149.0
				J	-2708.8	-30.4	-1927.9	-1668.8	-2195.6	-6250.4
			INVSLEQP Max	I	-2246.9	202.4	-553.0	353.0	1515.7	-5973.7
				J	-2246.5	202.4	-524.8	350.3	1732.4	-6055.0
			Min	I	-2326.8	191.4	-565.3	298.8	1492.8	-6207.0
				J	-2326.4	191.4	-537.1	296.1	1714.5	-6284.0
			INVSLEF Max	I	-1206.1	249.2	-565.2	906.2	4784.2	-2586.0
				J	-1205.6	249.2	-525.4	873.7	5228.6	-2663.8
			Min	I	-1979.5	79.4	-1516.7	-1130.0	-338.7	-5286.0
				J	-1978.9	79.4	-1475.8	-1153.0	15.7	-5345.5
1102	2	102	INVSLE Max	I	-879.7	554.2	-89.1	3360.5	9955.1	-751.4
				J	-883.8	554.2	-14.6	3267.9	10932.6	-874.9
			Min	I	-3644.9	-76.2	-2648.5	-2187.7	-2179.2	-8171.3
				J	-3643.8	-76.2	-2549.8	-2244.7	-1747.2	-8366.0
			INVSLE Min	I	319.1	885.7	-217.7	1096.6	3831.0	-976.4
				J	319.7	885.7	-177.3	1092.8	4167.2	-780.9
			Min	I	-4324.7	-597.5	-888.1	-344.0	-111.7	-9651.7

Sovrapasso di ingresso - Ponte strallato - Relazione di calcolo

			J	-4324.1	-597.5	-847.7	-347.8	150.5	-10009.0		
		INVSLEP	Max	I	-824.3	389.2	-412.4	1980.2	7447.5	-1199.6	
				J	-827.4	389.2	-346.8	1910.6	8152.9	-1296.4	
			Min	I	-2713.6	-48.2	-1929.9	-1543.2	-2208.6	-6249.4	
				J	-2712.6	-48.2	-1856.8	-1585.5	-1715.7	-6375.3	
		INVSLEQP	Max	I	-2249.1	157.6	-527.4	390.5	1718.7	-6053.5	
				J	-2248.5	157.6	-487.1	386.6	2003.6	-6142.0	
			Min	I	-2329.2	148.3	-539.6	336.2	1701.7	-6282.6	
				J	-2328.6	148.3	-499.3	332.3	1993.4	-6365.8	
		INVSLEF	Max	I	-1206.6	211.4	-527.0	933.9	5206.5	-2662.4	
				J	-1205.9	211.4	-470.2	889.5	5786.9	-2752.3	
			Min	I	-1982.0	55.7	-1477.6	-1057.2	11.7	-5345.3	
				J	-1981.3	55.7	-1418.2	-1088.2	484.2	-5414.0	
1103	2	102	INVSLEP	Max	I	-883.8	569.2	-14.1	3248.3	10939.1	-875.4
				J	-888.5	569.2	73.3	3150.1	12022.0	-1021.4	
			Min	I	-3641.8	-71.9	-2549.2	-2283.6	-1742.1	-8366.3	
				J	-3640.5	-71.9	-2435.9	-2354.6	-1289.9	-8600.9	
		INVSLEP	Max	I	298.2	875.0	-191.4	1087.5	4169.8	-777.1	
				J	298.9	875.0	-145.0	1083.1	4539.9	-541.5	
			Min	I	-4301.5	-570.2	-832.6	-363.2	153.6	-10013.3	
				J	-4300.8	-570.2	-786.1	-367.7	415.5	-10445.8	
		INVSLEF	Max	I	-827.4	399.9	-346.5	1894.8	8158.1	-1296.8	
				J	-830.8	399.9	-269.6	1821.0	8938.7	-1411.6	
			Min	I	-2711.7	-44.3	-1856.3	-1614.6	-1713.0	-6375.3	
				J	-2710.5	-44.3	-1772.4	-1667.3	-1179.1	-6527.5	
		INVSLEQP	Max	I	-2248.0	167.3	-486.5	376.7	2006.5	-6142.3	
				J	-2247.2	167.3	-440.0	372.3	2306.0	-6250.3	
			Min	I	-2328.1	157.6	-498.7	322.4	1996.2	-6366.1	
				J	-2327.3	157.6	-452.2	318.0	2303.6	-6467.9	
		INVSLEF	Max	I	-1205.8	219.5	-469.9	874.2	5790.3	-2752.5	
				J	-1205.0	219.5	-403.7	827.2	6427.9	-2859.6	
			Min	I	-1980.6	60.8	-1417.8	-1110.8	485.0	-5413.9	
				J	-1979.7	60.8	-1349.5	-1148.9	995.5	-5498.0	
1104	2	102	INVSLEP	Max	I	-888.2	473.8	69.9	3291.9	11981.5	-1019.2
				J	-893.0	473.8	156.1	3196.0	12977.0	-1121.1	
			Min	I	-3652.2	-99.4	-2439.4	-2086.6	-1321.7	-8598.8	
				J	-3651.0	-99.4	-2327.9	-2168.5	-916.8	-8793.8	
		INVSLEP	Max	I	282.6	766.3	-161.5	1121.9	4532.9	-543.2	
				J	283.3	766.3	-115.5	1117.5	4879.9	-293.4	
			Min	I	-4289.7	-566.6	-775.8	-259.2	386.1	-10441.6	
				J	-4289.0	-566.6	-729.8	-263.6	609.8	-10819.1	
		INVSLEF	Max	I	-830.6	331.8	-272.0	1939.6	8906.6	-1409.7	
				J	-834.1	331.8	-196.3	1867.4	9623.7	-1488.8	
			Min	I	-2716.0	-68.9	-1775.3	-1466.9	-1195.3	-6527.7	
				J	-2714.9	-68.9	-1692.7	-1527.6	-699.4	-6654.0	
		INVSLEQP	Max	I	-2249.9	106.1	-443.7	442.6	2287.4	-6248.8	
				J	-2249.2	106.1	-397.6	438.2	2563.3	-6316.7	
			Min	I	-2330.2	98.5	-455.7	388.6	2286.2	-6466.6	
				J	-2329.6	98.5	-409.7	384.2	2556.8	-6529.6	
		INVSLEF	Max	I	-1205.8	167.8	-406.0	939.6	6407.3	-2858.5	
				J	-1205.2	167.8	-340.9	893.6	6993.4	-2935.6	
			Min	I	-1983.2	28.4	-1351.9	-992.1	990.6	-5499.1	
				J	-1982.4	28.4	-1284.5	-1035.2	1456.5	-5560.1	
1105	2	102	INVSLEP	Max	I	-520.0	212.5	-301.3	1789.4	12616.8	-2458.9
				J	-523.5	212.5	-225.3	1682.6	13901.2	-2490.8	
			Min	I	-2904.9	-248.0	-2801.2	-4458.6	-1038.9	-12102.9	
				J	-2904.2	-248.0	-2692.3	-4486.6	-551.8	-12090.7	
		INVSLEP	Max	I	375.9	577.6	-237.4	249.0	4707.2	-1264.5	
				J	376.4	577.6	-191.4	244.6	5247.7	-965.4	
			Min	I	-3818.5	-659.7	-1139.3	-1611.6	523.8	-12290.5	
				J	-3818.0	-659.7	-1093.3	-1616.0	835.4	-12536.9	
		INVSLEF	Max	I	-548.3	133.8	-544.8	741.8	9350.9	-2516.0	
				J	-550.9	133.8	-476.5	661.5	10294.0	-2536.8	
			Min	I	-2091.7	-189.5	-2062.0	-3297.0	-817.8	-9365.1	
				J	-2091.0	-189.5	-1981.3	-3317.8	-248.1	-9333.4	
		INVSLEQP	Max	I	-1920.5	-53.2	-708.6	-852.0	2415.7	-7741.2	
				J	-1920.0	-53.2	-662.6	-856.5	2860.9	-7707.1	
			Min	I	-2001.6	-63.0	-718.3	-894.9	2408.1	-7957.8	
				J	-2001.1	-63.0	-672.2	-899.3	2847.1	-7917.4	
		INVSLEF	Max	I	-941.0	21.6	-642.9	-132.9	6789.1	-3997.0	
				J	-940.5	21.6	-582.5	-185.9	7546.1	-4006.6	
			Min	I	-1518.6	-90.3	-1591.4	-2401.9	1358.7	-7600.0	
				J	-1518.0	-90.3	-1525.7	-2423.2	1900.8	-7546.4	
1106	2	102	INVSLEP	Max	I	-518.6	150.8	-227.8	1821.1	13913.1	-2491.7
				J	-523.0	150.8	-150.1	1713.9	15121.6	-2497.1	
			Min	I	-2905.0	-263.2	-2694.0	-4200.2	-564.0	-12093.9	
				J	-2904.3	-263.2	-2583.4	-4227.7	-126.2	-12053.0	
		INVSLEP	Max	I	361.0	491.4	-210.5	276.6	5268.7	-967.6	
				J	361.4	491.4	-164.2	272.2	5805.8	-662.2	
			Min	I	-3798.2	-650.8	-1078.7	-1492.7	827.4	-12538.9	

Sovrapasso di ingresso - Ponte strallato - Relazione di calcolo

			J	-3797.7	-650.8	-1032.4	-1497.2	1091.1	-12741.5	
			INVSLE Max	I	-546.9	91.6	-478.3	785.1	10302.6	-2537.4
				J	-550.2	91.6	-408.8	704.6	11189.6	-2536.2
			Min	I	-2089.4	-204.2	-1982.8	-3104.8	-246.6	-9337.3
				J	-2088.8	-204.2	-1900.9	-3125.2	290.7	-9287.9
			INVSLEQP Max	I	-1917.1	-98.1	-665.3	-781.9	2871.6	-7709.5
				J	-1916.7	-98.1	-619.0	-786.3	3291.5	-7646.3
			Min	I	-1998.5	-106.1	-674.8	-824.1	2857.0	-7920.0
				J	-1998.0	-106.1	-628.5	-828.5	3270.7	-7851.6
			INVSLEF Max	I	-937.8	-10.6	-583.9	-67.2	7555.9	-4008.1
				J	-937.3	-10.6	-522.6	-120.5	8267.2	-3998.0
			Min	I	-1516.0	-112.2	-1527.3	-2260.1	1910.2	-7550.2
				J	-1515.4	-112.2	-1460.9	-2240.0	2419.6	-7481.2
1107	2	102	INVSLE Max	I	-521.7	134.2	-150.8	1755.4	15125.8	-2497.5
				J	-526.0	134.2	-82.4	1666.1	16158.0	-2495.8
			Min	I	-2904.3	-267.4	-2583.9	-4142.4	-129.8	-12054.0
				J	-2903.7	-267.4	-2488.1	-4169.1	217.7	-12011.4
			INVSLE Min	I	342.2	451.2	-183.0	278.6	5811.4	-659.9
				J	342.6	451.2	-142.4	274.7	6270.8	-393.3
			Min	I	-3777.0	-631.4	-1014.9	-1456.7	1088.8	-12745.1
				J	-3776.6	-631.4	-974.3	-1460.6	1284.1	-12909.7
			INVSLE Max	I	-549.1	80.2	-409.2	742.2	11192.7	-2536.5
				J	-552.3	80.2	-348.0	675.0	11950.1	-2530.0
			Min	I	-2088.2	-208.3	-1901.3	-3061.8	291.1	-9289.1
				J	-2087.6	-208.3	-1830.4	-3081.6	734.6	-9241.6
			INVSLEQP Max	I	-1915.8	-110.3	-619.7	-763.6	3294.3	-7647.0
				J	-1915.4	-110.3	-579.1	-767.5	3638.7	-7584.6
			Min	I	-1997.2	-117.7	-629.2	-805.6	3273.3	-7852.3
				J	-1996.8	-117.7	-588.6	-809.5	3612.3	-7785.7
			INVSLEF Max	I	-936.5	-19.3	-523.0	-84.7	8270.3	-3998.4
				J	-936.1	-19.3	-469.2	-129.2	8876.3	-3984.8
			Min	I	-1514.8	-118.2	-1461.3	-2191.7	2421.9	-7482.3
				J	-1514.3	-118.2	-1403.7	-2233.7	2840.8	-7418.2
1108	2	103	INVSLE Max	I	-523.5	107.4	-83.6	1747.6	16166.1	-2496.5
				J	-526.7	107.4	-36.0	1683.2	16842.3	-2487.2
			Min	I	-2903.4	-275.0	-2489.0	-4007.6	210.9	-12013.1
				J	-2903.0	-275.0	-2420.9	-4026.8	442.3	-11974.3
			INVSLE Min	I	329.0	403.8	-158.1	293.3	6279.9	-393.1
				J	329.3	403.8	-130.0	290.5	6596.4	-205.0
			Min	I	-3760.1	-621.7	-960.9	-1387.3	1280.7	-12912.3
				J	-3759.9	-621.7	-932.8	-1390.0	1401.7	-13013.0
			INVSLE Max	I	-550.3	59.7	-348.9	749.6	11956.0	-2530.6
				J	-552.6	59.7	-306.4	701.3	12451.8	-2519.3
			Min	I	-2086.4	-215.6	-1831.1	-2961.7	735.4	-9243.6
				J	-2086.1	-215.6	-1780.7	-2976.0	1035.9	-9204.7
			INVSLEQP Max	I	-1913.6	-132.2	-580.4	-722.7	3643.7	-7586.0
				J	-1913.3	-132.2	-552.3	-725.5	3874.7	-7532.9
			Min	I	-1995.1	-138.7	-589.9	-764.3	3616.9	-7787.2
				J	-1994.8	-138.7	-561.8	-767.1	3844.1	-7731.5
			INVSLEF Max	I	-934.7	-35.0	-470.0	-58.7	8882.1	-3985.7
				J	-934.4	-35.0	-432.7	-90.8	9279.9	-3970.1
			Min	I	-1513.0	-129.0	-1404.4	-2143.7	2845.0	-7420.1
				J	-1512.7	-129.0	-1363.6	-2174.6	3128.0	-7370.1
1109	2	103	INVSLE Max	I	-526.6	107.4	-31.8	1685.0	16842.2	-2487.2
				J	-529.7	107.4	17.1	1622.8	17524.0	-2477.9
			Min	I	-2903.0	-275.0	-2415.1	-4024.4	442.3	-11974.3
				J	-2902.6	-275.0	-2349.0	-4004.1	659.7	-11935.6
			INVSLE Min	I	313.6	385.8	-140.7	288.3	6596.4	-201.9
				J	313.9	385.8	-112.6	285.5	6901.0	-17.2
			Min	I	-3744.2	-603.7	-913.6	-1384.2	1401.7	-13016.1
				J	-3743.9	-603.7	-885.5	-1387.0	1508.7	-13113.4
			INVSLE Max	I	-552.6	59.7	-302.1	703.1	12451.8	-2519.3
				J	-554.9	59.7	-258.6	656.2	12951.7	-2507.9
			Min	I	-2086.0	-215.6	-1776.4	-2974.2	1035.9	-9204.7
				J	-2085.7	-215.6	-1727.5	-2959.2	1323.1	-9165.8
			INVSLEQP Max	I	-1913.3	-132.2	-548.0	-723.7	3874.6	-7532.9
				J	-1913.1	-132.2	-519.9	-726.5	4092.6	-7479.9
			Min	I	-1994.8	-138.7	-557.5	-765.3	3844.1	-7731.5
				J	-1994.5	-138.7	-529.4	-768.1	4058.3	-7675.9
			INVSLEF Max	I	-934.4	-35.0	-428.5	-89.1	9279.8	-3970.1
				J	-934.1	-35.0	-390.5	-120.3	9679.5	-3954.5
			Min	I	-1512.7	-129.0	-1359.3	-2172.8	3128.0	-7370.1
				J	-1512.4	-129.0	-1319.6	-2204.2	3397.7	-7320.2
1110	2	102	INVSLE Max	I	-523.3	42.9	14.0	1851.4	17536.0	-2480.1
				J	-527.8	42.9	82.7	1761.2	18401.1	-2438.7
			Min	I	-2900.6	-294.9	-2351.3	-3580.4	642.2	-11941.7
				J	-2900.1	-294.9	-2255.3	-3660.5	928.4	-11855.9
			INVSLE Min	I	304.8	298.5	-129.4	346.7	6921.1	-21.1
				J	305.1	298.5	-89.0	342.8	7330.9	238.2
			Min	I	-3725.6	-612.5	-874.5	-1189.4	1500.4	-13116.0

Sovrapasso di ingresso - Ponte strallato - Relazione di calcolo

			J	-3725.4	-612.5	-834.1	-1193.2	1632.1	-13198.8		
		INVSLE	Max	I	-549.6	8.0	-260.9	868.5	12960.5	-2509.8	
				J	-552.9	8.0	-199.5	800.7	13594.4	-2470.3	
			Min	I	-2081.6	-234.6	-1729.4	-2645.0	1325.2	-9172.2	
				J	-2081.2	-234.6	-1658.3	-2704.3	1709.2	-9098.4	
		INVSLEQP	Max	I	-1907.5	-188.1	-523.3	-599.6	4104.0	-7483.8	
				J	-1907.2	-188.1	-482.9	-603.5	4392.1	-7378.1	
			Min	I	-1989.1	-192.3	-532.7	-639.9	4068.7	-7679.9	
				J	-1988.9	-192.3	-492.3	-643.8	4351.5	-7571.8	
		INVSLEF	Max	I	-929.9	-74.7	-392.4	78.9	9688.8	-3957.1	
				J	-929.6	-74.7	-338.1	33.7	10198.0	-3914.0	
			Min	I	-1508.3	-156.8	-1321.5	-1953.4	3407.1	-7326.0	
				J	-1508.0	-156.8	-1263.5	-1994.3	3766.4	-7239.5	
1111	2	102	INVSLE	Max	I	-528.6	50.9	83.1	1731.1	18399.3	-2438.4
				J	-533.7	50.9	166.8	1638.8	19342.2	-2395.0	
			Min	I	-2900.5	-292.3	-2255.0	-3715.9	930.5	-11855.2	
				J	-2899.9	-292.3	-2145.8	-3813.0	1228.8	-11761.7	
		INVSLE	Max	I	283.1	283.1	-110.2	328.7	7328.2	243.5	
				J	283.4	283.1	-64.0	324.2	7765.6	530.5	
			Min	I	-3704.6	-585.1	-812.2	-1213.2	1633.6	-13203.2	
				J	-3704.3	-585.1	-766.0	-1217.7	1758.7	-13296.2	
		INVSLE	Max	I	-553.6	14.4	-199.2	772.5	13593.0	-2470.1	
				J	-557.4	14.4	-125.3	702.9	14283.5	-2428.3	
			Min	I	-2081.8	-232.2	-1658.1	-2745.4	1708.9	-9097.6	
				J	-2081.3	-232.2	-1577.1	-2817.3	2119.3	-9016.1	
		INVSLEQP	Max	I	-1908.0	-181.1	-482.5	-620.3	4390.7	-7377.6	
				J	-1907.6	-181.1	-436.4	-624.7	4691.7	-7261.2	
			Min	I	-1989.6	-185.7	-491.9	-660.7	4350.3	-7571.2	
				J	-1989.3	-185.7	-445.7	-665.2	4645.2	-7452.0	
		INVSLEF	Max	I	-930.2	-69.8	-337.9	7.4	10196.7	-3913.6	
				J	-929.8	-69.8	-274.0	-38.9	10751.7	-3867.4	
			Min	I	-1508.5	-153.3	-1263.3	-2027.1	3765.4	-7238.7	
				J	-1508.1	-153.3	-1197.1	-2076.3	4147.6	-7142.3	
1112	2	102	INVSLE	Max	I	-530.4	17.7	165.0	1772.5	19352.6	-2396.4
				J	-535.6	17.7	248.8	1681.4	20213.0	-2335.8	
			Min	I	-2898.2	-303.0	-2147.0	-3567.9	1220.0	-11765.9	
				J	-2897.7	-303.0	-2037.7	-3666.0	1490.7	-11653.1	
		INVSLE	Max	I	264.5	224.6	-87.9	357.3	7774.3	531.6	
				J	264.8	224.6	-41.6	352.9	8179.0	813.4	
			Min	I	-3679.9	-576.9	-745.2	-1099.2	1755.2	-13301.1	
				J	-3679.6	-576.9	-698.8	-1103.6	1858.1	-13355.6	
		INVSLE	Max	I	-554.5	-12.3	-126.5	829.1	14291.2	-2429.4	
				J	-558.4	-12.3	-52.4	760.4	14920.6	-2373.2	
			Min	I	-2078.7	-242.4	-1578.2	-2635.9	2120.6	-9020.1	
				J	-2078.2	-242.4	-1497.3	-2708.5	2503.8	-8926.7	
		INVSLEQP	Max	I	-1904.3	-210.4	-438.2	-549.9	4697.2	-7263.4	
				J	-1904.0	-210.4	-391.8	-554.3	4970.9	-7127.7	
			Min	I	-1986.0	-213.7	-447.4	-589.4	4650.2	-7454.3	
				J	-1985.7	-213.7	-401.1	-593.9	4918.0	-7316.4	
		INVSLEF	Max	I	-927.4	-90.4	-275.1	78.7	10758.5	-3868.9	
				J	-927.1	-90.4	-211.2	32.9	11266.5	-3809.7	
			Min	I	-1505.7	-168.0	-1198.1	-1930.6	4152.2	-7145.8	
				J	-1505.3	-168.0	-1131.8	-1980.1	4507.0	-7039.0	
1113	2	102	INVSLE	Max	I	190.4	-94.1	-61.9	786.4	19774.8	-4848.4
				J	186.2	-94.1	14.7	689.4	20811.2	-4752.3	
			Min	I	-2102.8	-490.4	-2403.4	-5098.7	1274.0	-16259.7	
				J	-2102.7	-490.4	-2292.7	-5129.9	1590.7	-15983.9	
		INVSLE	Max	I	523.5	110.3	-83.3	117.3	7903.7	-797.5	
				J	523.6	110.3	-37.2	112.9	8424.0	-517.5	
			Min	I	-2973.5	-635.5	-949.2	-2001.0	1730.6	-15932.0	
				J	-2973.4	-635.5	-903.0	-2005.5	1843.6	-15874.8	
		INVSLE	Max	I	-25.8	-90.5	-281.5	65.6	14597.3	-4206.8	
				J	-29.0	-90.5	-212.8	-7.4	15351.8	-4124.9	
			Min	I	-1374.5	-380.1	-1759.8	-3732.8	2302.3	-12560.3	
				J	-1374.4	-380.1	-1677.8	-3755.9	2717.5	-12342.5	
		INVSLEQP	Max	I	-1480.6	-279.3	-492.7	-927.7	4802.0	-8968.9	
				J	-1480.4	-279.3	-446.5	-932.2	5108.0	-8789.6	
			Min	I	-1561.1	-284.7	-499.7	-956.0	4747.2	-9152.5	
				J	-1561.0	-284.7	-453.5	-960.4	5048.7	-8969.7	
		INVSLEF	Max	I	-402.5	-155.8	-398.7	-529.3	11000.1	-5732.3	
				J	-401.5	-155.8	-338.2	-579.2	11593.1	-5632.2	
			Min	I	-928.7	-297.7	-1334.6	-2685.4	4327.7	-9935.3	
				J	-928.5	-297.7	-1268.2	-2735.0	4713.0	-9745.8	
1114	2	102	INVSLE	Max	I	192.5	-109.2	13.5	833.7	20835.8	-4754.4
				J	187.5	-109.2	91.6	738.0	21796.8	-4647.1	
			Min	I	-2099.6	-499.3	-2293.0	-4843.3	1588.3	-15989.5	
				J	-2099.5	-499.3	-2181.2	-4852.2	1877.8	-15708.0	
		INVSLE	Max	I	504.9	66.7	-63.6	138.7	8444.4	-515.9	
				J	505.0	66.7	-17.2	134.2	8932.3	-244.4	
			Min	I	-2945.9	-627.5	-878.7	-1866.8	1842.9	-15881.8	

Sovrapasso di ingresso - Ponte strallato - Relazione di calcolo

			J	-2945.8	-627.5	-832.3	-1871.3	1933.4	-15791.2		
		INVSLEP	Max	I	-24.0	-104.3	-213.5	130.8	15369.5	-4126.5	
				J	-27.7	-104.3	-143.6	58.7	16068.2	-4034.6	
			Min	I	-1371.2	-388.7	-1678.2	-3544.1	2724.6	-12346.8	
				J	-1371.1	-388.7	-1595.3	-3550.7	3112.6	-12123.4	
		INVSLEQP	Max	I	-1475.7	-302.1	-447.9	-850.7	5118.2	-8792.4	
				J	-1475.6	-302.1	-401.5	-855.1	5396.8	-8597.4	
			Min	I	-1556.3	-306.3	-454.8	-877.9	5058.5	-8972.5	
				J	-1556.2	-306.3	-408.4	-882.4	5332.6	-8774.8	
		INVSLEF	Max	I	-396.7	-168.6	-338.7	-450.7	11606.8	-5634.2	
				J	-396.2	-168.6	-277.4	-500.1	12156.6	-5525.4	
			Min	I	-925.4	-304.2	-1268.7	-2574.5	4722.3	-9749.3	
				J	-925.3	-304.2	-1201.6	-2624.0	5080.2	-9554.8	
1115	2	102	INVSLEP	Max	I	192.2	-120.6	90.7	853.5	21819.6	-4648.6
				J	187.8	-120.6	158.5	772.6	22595.1	-4548.8	
			Min	I	-2096.9	-506.1	-2181.4	-4636.8	1876.1	-15712.0	
				J	-2096.9	-506.1	-2085.2	-4727.4	2102.7	-15466.0	
		INVSLEF	Max	I	486.7	32.0	-42.7	153.0	8946.7	-242.0	
				J	486.7	32.0	-2.6	149.2	9337.3	-15.9	
			Min	I	-2920.5	-620.0	-808.5	-1758.2	1933.2	-15797.8	
				J	-2920.4	-620.0	-768.4	-1762.1	1995.1	-15695.8	
		INVSLEP	Max	I	-23.9	-114.7	-144.1	169.7	16084.7	-4035.8	
				J	-27.2	-114.7	-83.6	108.8	16647.9	-3950.1	
			Min	I	-1368.5	-395.1	-1595.6	-3391.6	3117.9	-12126.5	
				J	-1368.4	-395.1	-1524.3	-3458.7	3429.5	-11930.6	
		INVSLEQP	Max	I	-1471.8	-319.4	-402.6	-789.9	5404.1	-8599.5	
				J	-1471.8	-319.4	-362.5	-793.8	5621.3	-8421.3	
			Min	I	-1552.5	-322.7	-409.4	-816.3	5339.6	-8777.0	
				J	-1552.4	-322.7	-369.3	-820.2	5553.1	-8597.0	
		INVSLEF	Max	I	-392.6	-178.2	-277.8	-397.0	12169.1	-5526.9	
				J	-392.2	-178.2	-224.8	-438.9	12612.6	-5427.5	
			Min	I	-922.8	-309.2	-1201.9	-2496.0	5087.0	-9557.3	
				J	-922.7	-309.2	-1144.0	-2540.9	5372.4	-9386.5	
1116	2	103	INVSLEP	Max	I	193.1	-133.8	157.5	915.8	22621.0	-4550.6
				J	189.8	-133.8	205.6	856.8	23135.6	-4472.4	
			Min	I	-2093.5	-514.0	-2085.5	-4459.5	2100.5	-15471.4	
				J	-2093.5	-514.0	-2016.9	-4523.8	2251.0	-15291.4	
		INVSLEF	Max	I	473.2	1.3	-23.2	176.4	9353.6	-14.8	
				J	473.2	1.3	5.1	173.7	9617.4	143.6	
			Min	I	-2898.2	-621.7	-749.8	-1625.7	1994.4	-15701.9	
				J	-2898.2	-621.7	-721.6	-1628.5	2030.9	-15610.2	
		INVSLEP	Max	I	-22.9	-126.9	-84.2	246.8	16666.6	-3951.6	
				J	-25.4	-126.9	-41.2	202.4	17039.7	-3884.2	
			Min	I	-1365.2	-402.7	-1524.7	-3261.0	3435.5	-11934.7	
				J	-1365.2	-402.7	-1473.9	-3308.6	3647.1	-11790.7	
		INVSLEQP	Max	I	-1467.0	-340.0	-363.7	-713.0	5629.4	-8423.9	
				J	-1467.0	-340.0	-335.5	-715.8	5773.0	-8286.9	
			Min	I	-1547.7	-342.2	-370.5	-738.4	5560.8	-8599.7	
				J	-1547.7	-342.2	-342.3	-741.2	5701.8	-8461.7	
		INVSLEF	Max	I	-388.0	-189.5	-225.2	-310.8	12626.7	-5429.3	
				J	-387.9	-189.5	-187.8	-341.4	12921.2	-5352.7	
			Min	I	-919.6	-315.0	-1144.4	-2381.6	5379.9	-9389.9	
				J	-919.6	-315.0	-1103.2	-2413.4	5572.6	-9264.3	
1117	2	103	INVSLEP	Max	I	189.8	-133.8	209.9	858.6	23135.6	-4472.4
				J	186.3	-133.8	259.1	801.2	23645.0	-4394.2	
			Min	I	-2093.5	-514.0	-2011.1	-4521.4	2251.0	-15291.4	
				J	-2093.4	-514.0	-1943.3	-4587.1	2388.3	-15111.4	
		INVSLEF	Max	I	457.2	-11.8	-10.4	168.2	9616.4	147.5	
				J	457.2	-11.8	17.9	165.4	9861.1	300.8	
			Min	I	-2882.1	-608.5	-697.6	-1619.5	2031.8	-15614.1	
				J	-2882.1	-608.5	-669.4	-1622.3	2061.2	-15517.3	
		INVSLEP	Max	I	-25.4	-126.9	-36.9	204.2	17039.7	-3884.2	
				J	-28.0	-126.9	6.8	161.0	17408.9	-3816.9	
			Min	I	-1365.2	-402.7	-1469.6	-3306.9	3647.1	-11790.7	
				J	-1365.1	-402.7	-1419.4	-3355.5	3845.6	-11646.8	
		INVSLEQP	Max	I	-1467.0	-340.0	-331.2	-714.0	5773.0	-8286.9	
				J	-1467.0	-340.0	-303.0	-716.8	5903.6	-8149.8	
			Min	I	-1547.7	-342.2	-338.0	-739.4	5701.8	-8461.7	
				J	-1547.7	-342.2	-309.8	-742.1	5829.6	-8323.7	
		INVSLEF	Max	I	-387.9	-189.5	-183.5	-339.6	12921.2	-5352.8	
				J	-387.8	-189.5	-145.5	-369.6	13211.8	-5276.2	
			Min	I	-919.6	-315.0	-1098.9	-2411.6	5572.6	-9264.3	
				J	-919.6	-315.0	-1058.0	-2443.9	5752.1	-9138.7	
1118	2	102	INVSLEP	Max	I	190.8	-144.5	258.2	931.0	23658.7	-4395.8
				J	185.9	-144.5	328.2	853.6	24303.3	-4279.1	
			Min	I	-2090.2	-520.9	-1943.6	-4344.3	2386.5	-15115.7	
				J	-2090.2	-520.9	-1850.0	-4434.9	2559.8	-14861.4	
		INVSLEF	Max	I	442.9	-36.6	-3.1	189.1	9874.0	302.6	
				J	442.9	-36.6	37.4	185.2	10188.2	509.6	
			Min	I	-2860.1	-611.7	-650.1	-1497.8	2060.8	-15523.3	

Sovrapasso di ingresso - Ponte strallato - Relazione di calcolo

			J	-2860.1	-611.7	-609.6	-1501.7	2091.9	-15365.0		
		INVSLE	Max	I	-24.3	-136.8	6.3	286.7	17418.6	-3818.1	
				J	-28.0	-136.8	68.7	228.4	17884.9	-3717.5	
			Min	I	-1362.1	-409.3	-1419.7	-3176.5	3850.7	-11650.1	
				J	-1362.1	-409.3	-1350.4	-3243.7	4109.2	-11445.9	
		INVSLEQP	Max	I	-1462.7	-357.8	-304.1	-643.9	5910.1	-8152.1	
				J	-1462.7	-357.8	-263.6	-647.8	6073.8	-7950.4	
			Min	I	-1543.4	-359.1	-310.8	-668.2	5835.9	-8326.0	
				J	-1543.4	-359.1	-270.3	-672.1	5995.8	-8123.7	
		INVSLEF	Max	I	-384.2	-199.0	-145.9	-253.2	13219.0	-5277.7	
				J	-384.1	-199.0	-91.8	-293.5	13586.9	-5165.2	
			Min	I	-916.8	-320.0	-1058.4	-2299.7	5758.1	-9141.4	
				J	-916.8	-320.0	-1000.5	-2344.2	5990.1	-8963.1	
1119	2	102	INVSLE	Max	I	188.1	-149.8	327.8	919.8	24313.9	-4279.8
				J	182.4	-149.8	409.5	838.2	24983.9	-4141.9	
			Min	I	-2088.5	-524.3	-1850.1	-4310.8	2558.9	-14863.8	
				J	-2088.5	-524.3	-1741.8	-4416.4	2729.7	-14571.0	
		INVSLE	Max	I	422.7	-56.3	10.7	191.4	10193.4	513.9	
				J	422.7	-56.3	57.0	186.9	10511.2	740.0	
			Min	I	-2835.9	-605.8	-583.7	-1432.4	2092.6	-15371.3	
				J	-2835.9	-605.8	-537.3	-1436.8	2114.7	-15170.2	
		INVSLE	Max	I	-26.2	-141.7	68.4	292.6	17892.5	-3718.1	
				J	-30.4	-141.7	141.0	231.0	18376.0	-3599.0	
			Min	I	-1360.6	-412.5	-1350.5	-3152.3	4111.6	-11447.8	
				J	-1360.6	-412.5	-1270.3	-3230.5	4379.8	-11212.3	
		INVSLEQP	Max	I	-1460.5	-366.7	-264.1	-610.6	6076.9	-7951.5	
				J	-1460.6	-366.7	-217.7	-615.1	6236.7	-7714.9	
			Min	I	-1541.3	-367.5	-270.8	-634.5	5998.7	-8124.8	
				J	-1541.3	-367.5	-224.4	-639.0	6154.2	-7887.6	
		INVSLEF	Max	I	-382.3	-203.7	-92.0	-234.0	13592.5	-5165.9	
				J	-382.3	-203.7	-29.2	-276.7	13974.5	-5033.7	
			Min	I	-915.4	-322.5	-1000.7	-2270.5	5992.9	-8964.6	
				J	-915.4	-322.5	-934.6	-2322.0	6230.6	-8758.9	
1120	2	102	INVSLE	Max	I	192.9	-172.2	407.5	1164.5	25028.4	-4145.4
				J	187.1	-172.2	488.2	1079.6	25586.5	-3988.2	
			Min	I	-2079.6	-542.3	-1742.3	-3802.6	2724.8	-14581.5	
				J	-2079.7	-542.3	-1634.0	-3903.0	2866.9	-14282.9	
		INVSLE	Max	I	405.6	-88.9	28.4	256.3	10537.4	741.2	
				J	405.5	-88.9	74.6	251.9	10809.4	955.6	
			Min	I	-2798.8	-639.5	-512.7	-1133.8	2112.5	-15181.1	
				J	-2798.9	-639.5	-466.5	-1138.3	2121.8	-14927.8	
		INVSLE	Max	I	-21.7	-163.0	139.8	549.3	18408.1	-3601.9	
				J	-26.0	-163.0	211.6	485.2	18808.9	-3465.5	
			Min	I	-1352.7	-429.7	-1271.0	-2778.6	4390.2	-11220.4	
				J	-1352.8	-429.7	-1190.7	-2853.0	4628.3	-10978.3	
		INVSLEQP	Max	I	-1449.5	-407.6	-220.3	-432.5	6249.3	-7720.2	
				J	-1449.6	-407.6	-174.1	-436.9	6380.2	-7457.5	
			Min	I	-1530.2	-409.0	-226.8	-453.7	6166.3	-7893.0	
				J	-1530.3	-409.0	-180.7	-458.2	6292.9	-7631.2	
		INVSLEF	Max	I	-373.5	-224.4	-30.1	17.7	13997.8	-5037.1	
				J	-373.6	-224.4	31.8	-26.5	14316.4	-4890.3	
			Min	I	-908.4	-335.7	-935.4	-1957.7	6242.1	-8765.5	
				J	-908.4	-335.7	-869.4	-2006.7	6449.8	-8553.6	
1121	2	102	INVSLE	Max	I	673.2	-250.3	240.9	272.2	25342.2	-5570.9
				J	667.3	-250.3	319.4	187.1	25999.3	-5392.2	
			Min	I	-1620.8	-716.1	-1909.6	-4829.6	2711.6	-17611.5	
				J	-1621.0	-716.1	-1800.0	-4930.1	2911.1	-17191.3	
		INVSLE	Max	I	490.3	-131.2	20.3	81.2	10622.7	231.4	
				J	490.1	-131.2	66.1	76.8	10965.8	437.3	
			Min	I	-2268.1	-709.4	-641.6	-1927.8	2076.5	-16879.8	
				J	-2268.3	-709.4	-595.8	-1932.2	2100.3	-16549.7	
		INVSLE	Max	I	325.5	-218.3	41.2	-119.3	18630.2	-4597.1	
				J	321.1	-218.3	111.2	-183.5	19101.4	-4444.9	
			Min	I	-974.6	-543.4	-1389.7	-3518.3	4509.0	-13389.5	
				J	-974.8	-543.4	-1308.6	-3592.8	4773.6	-13059.7	
		INVSLEQP	Max	I	-1200.6	-455.9	-257.4	-780.4	6288.8	-8549.7	
				J	-1200.8	-455.9	-211.5	-784.8	6440.7	-8259.0	
			Min	I	-1278.8	-457.4	-261.1	-788.2	6200.0	-8712.3	
				J	-1279.0	-457.4	-215.3	-792.6	6349.5	-8420.7	
		INVSLEF	Max	I	0.2	-272.9	-102.7	-485.3	14169.7	-6040.5	
				J	-0.0	-272.9	-41.7	-530.4	14535.5	-5864.8	
			Min	I	-608.8	-427.7	-1018.8	-2540.3	6350.1	-10350.2	
				J	-609.0	-427.7	-952.7	-2588.6	6579.7	-10081.1	
1122	2	102	INVSLE	Max	I	669.5	-252.4	319.3	234.3	26009.2	-5392.8
				J	662.3	-252.4	400.7	151.8	26608.4	-5210.4	
			Min	I	-1619.4	-717.8	-1800.1	-4839.3	2912.4	-17192.5	
				J	-1619.7	-717.8	-1689.4	-4945.5	3084.5	-16768.8	
		INVSLE	Max	I	468.2	-136.5	36.5	74.6	10970.4	442.7	
				J	468.0	-136.5	82.8	70.2	11271.3	639.3	
			Min	I	-2243.1	-711.0	-566.6	-1876.1	2102.2	-16556.8	

Sovrapasso di ingresso - Ponte strallato - Relazione di calcolo

			J	-2243.3	-711.0	-520.3	-1880.6	2113.0	-16207.3	
			INVSLE Max	I	322.9	-220.5	111.3	-137.2	19108.6	-4445.4
				J	317.6	-220.5	183.5	-199.4	19536.7	-4289.8
			Min	I	-973.6	-543.4	-1308.6	-3526.1	4776.4	-13060.6
				J	-973.9	-543.4	-1226.7	-3604.7	5014.2	-12727.7
			INVSLEQP Max	I	-1199.0	-460.8	-211.8	-758.5	6443.5	-8259.8
				J	-1199.2	-460.8	-165.5	-763.0	6567.5	-7962.9
			Min	I	-1277.2	-462.0	-215.6	-765.9	6352.2	-8421.5
				J	-1277.5	-462.0	-169.3	-770.4	6473.8	-8123.9
			INVSLEF Max	I	1.8	-274.9	-41.7	-487.5	14540.6	-5865.3
				J	0.6	-274.9	21.0	-531.5	14872.7	-5686.4
			Min	I	-607.9	-427.8	-952.8	-2534.9	6582.4	-10081.8
				J	-608.1	-427.8	-885.9	-2585.8	6784.8	-9809.9
1123	2	102	INVSLE Max	I	676.8	-263.8	400.0	451.4	26678.1	-5213.8
				J	673.9	-263.8	470.8	378.0	27113.8	-5043.5
			Min	I	-1609.7	-727.9	-1689.5	-4368.1	3092.1	-16776.8
				J	-1609.9	-727.9	-1592.3	-4460.6	3220.0	-16409.0
			INVSLE Min	I	452.0	-139.4	55.1	124.0	11305.9	641.8
				J	451.7	-139.4	95.8	120.1	11532.4	804.1
			Min	I	-2205.9	-750.2	-495.0	-1592.4	2115.0	-16219.5
				J	-2206.2	-750.2	-454.3	-1596.4	2114.6	-15878.1
			INVSLE Max	I	329.1	-233.3	183.7	95.2	19587.3	-4292.6
				J	327.0	-233.3	246.6	39.8	19896.3	-4146.1
			Min	I	-966.1	-544.1	-1227.0	-3180.6	5030.6	-12733.9
				J	-966.4	-544.1	-1155.0	-3249.1	5215.5	-12442.7
			INVSLEQP Max	I	-1187.6	-490.5	-167.3	-596.9	6583.2	-7968.0
				J	-1187.9	-490.5	-126.6	-600.9	6668.5	-7689.9
			Min	I	-1265.9	-491.2	-170.9	-601.9	6489.4	-8129.0
				J	-1266.1	-491.2	-130.2	-605.8	6572.6	-7851.2
			INVSLEF Max	I	11.8	-286.7	20.8	-259.1	14908.8	-5689.5
				J	10.2	-286.7	75.3	-298.1	15149.1	-5524.4
			Min	I	-600.7	-428.9	-886.0	-2244.8	6799.9	-9814.8
				J	-600.9	-428.9	-827.1	-2289.3	6953.6	-9575.8
1124	2	103	INVSLE Max	I	676.4	-265.3	470.7	428.1	27123.4	-5044.0
				J	675.1	-265.3	521.2	377.5	27408.9	-4922.2
			Min	I	-1608.2	-729.5	-1592.3	-4363.9	3221.1	-16410.1
				J	-1608.4	-729.5	-1524.6	-4429.9	3298.0	-16150.3
			INVSLE Min	I	435.5	-139.5	74.3	121.8	11536.4	808.3
				J	435.3	-139.5	102.3	119.1	11674.7	917.9
			Min	I	-2186.3	-757.0	-433.2	-1541.0	2116.0	-15883.9
				J	-2186.5	-757.0	-405.1	-1543.7	2110.3	-15634.1
			INVSLE Max	I	329.0	-235.1	246.7	89.1	19903.3	-4146.5
				J	328.0	-235.1	291.4	50.9	20105.1	-4041.6
			Min	I	-965.1	-544.5	-1155.0	-3178.1	5218.0	-12443.6
				J	-965.2	-544.5	-1104.8	-3227.0	5335.1	-12237.6
			INVSLEQP Max	I	-1185.9	-495.1	-126.9	-573.2	6670.8	-7690.8
				J	-1186.1	-495.1	-98.8	-576.0	6717.5	-7491.9
			Min	I	-1264.2	-496.1	-130.5	-577.8	6574.9	-7852.1
				J	-1264.3	-496.1	-102.4	-580.5	6620.1	-7653.6
			INVSLEF Max	I	12.0	-288.4	75.3	-252.5	15154.0	-5524.9
				J	11.3	-288.4	113.8	-279.5	15310.7	-5407.0
			Min	I	-599.7	-429.3	-827.2	-2232.3	6955.7	-9576.5
				J	-599.9	-429.3	-786.1	-2263.9	7050.8	-9407.4
1125	2	103	INVSLE Max	I	675.1	-265.3	525.5	379.3	27408.9	-4922.2
				J	673.1	-265.3	575.7	330.7	27674.8	-4800.4
			Min	I	-1608.4	-729.5	-1518.8	-4427.5	3298.0	-16150.3
				J	-1608.6	-729.5	-1451.5	-4493.7	3361.9	-15890.5
			INVSLE Min	I	419.2	-139.0	86.9	112.1	11673.3	922.3
				J	419.0	-139.0	114.9	109.3	11790.5	1026.8
			Min	I	-2170.4	-757.5	-381.1	-1533.2	2111.7	-15638.5
				J	-2170.6	-757.5	-353.0	-1536.0	2101.2	-15383.7
			INVSLE Max	I	328.0	-235.1	295.7	52.7	20105.1	-4041.6
				J	326.6	-235.1	340.1	16.0	20292.4	-3936.7
			Min	I	-965.3	-544.5	-1100.5	-3225.3	5335.1	-12237.6
				J	-965.5	-544.5	-1050.7	-3274.3	5439.3	-12031.6
			INVSLEQP Max	I	-1186.1	-495.1	-94.6	-574.2	6717.5	-7491.9
				J	-1186.3	-495.1	-66.5	-577.0	6751.2	-7293.0
			Min	I	-1264.4	-496.1	-98.2	-578.7	6620.2	-7653.6
				J	-1264.5	-496.1	-70.1	-581.5	6652.4	-7455.1
			INVSLEF Max	I	11.2	-288.4	118.0	-277.7	15310.7	-5407.0
				J	10.1	-288.4	156.2	-303.9	15455.6	-5289.1
			Min	I	-599.9	-429.3	-781.9	-2262.1	7050.8	-9407.4
				J	-600.1	-429.3	-741.0	-2293.7	7132.9	-9238.2
1126	2	102	INVSLE Max	I	684.9	-272.7	575.2	589.4	27714.8	-4802.7
				J	681.6	-272.7	647.7	519.3	28012.1	-4623.5
			Min	I	-1599.6	-737.7	-1451.6	-3998.6	3367.6	-15896.8
				J	-1599.9	-737.7	-1355.8	-4089.9	3438.9	-15536.6
			INVSLE Min	I	406.1	-136.2	94.6	157.1	11814.6	1029.5
				J	405.8	-136.2	135.0	153.2	11948.4	1168.2
			Min	I	-2139.3	-795.0	-334.7	-1289.7	2102.6	-15393.9

Sovrappasso di ingresso - Ponte strallato - Relazione di calcolo

			J	-2139.6	-795.0	-294.3	-1293.5	2081.1	-15009.5	
			INVSLE Max	I	336.1	-244.0	340.3	275.1	20321.3	-3938.7
				J	333.6	-244.0	404.5	222.2	20528.1	-3783.4
			Min	I	-958.6	-546.0	-1051.0	-2910.9	5451.3	-12036.5
				J	-958.9	-546.0	-980.0	-2978.5	5578.5	-11749.2
			INVSLEQP Max	I	-1176.1	-518.7	-67.9	-435.7	6761.9	-7297.1
				J	-1176.5	-518.7	-27.5	-439.6	6790.7	-7004.3
			Min	I	-1254.3	-521.2	-71.4	-438.0	6663.0	-7459.2
				J	-1254.6	-521.2	-31.1	-441.9	6689.8	-7167.8
			INVSLEF Max	I	18.7	-296.7	156.2	-68.1	15475.1	-5291.4
				J	16.9	-296.7	211.2	-105.6	15635.6	-5119.6
			Min	I	-593.7	-431.1	-741.2	-1998.7	7142.9	-9242.1
				J	-594.0	-431.1	-682.8	-2042.3	7239.1	-9005.1
1127	2	102	INVSLE Max	I	687.9	-276.6	647.5	667.0	28038.5	-4624.7
				J	687.0	-276.6	732.2	591.3	28298.9	-4412.8
			Min	I	-1594.6	-742.4	-1355.9	-3806.7	3441.8	-15539.6
				J	-1595.0	-742.4	-1245.8	-3910.3	3496.4	-15127.9
			INVSLE Min	I	386.4	-129.8	110.3	175.3	11959.1	1173.4
				J	386.0	-129.8	156.7	170.8	12067.5	1322.4
			Min	I	-2109.5	-820.8	-270.6	-1148.1	2082.8	-15018.8
				J	-2109.9	-820.8	-224.2	-1152.6	2048.1	-14553.3
			INVSLE Max	I	338.8	-248.8	404.6	370.9	20547.3	-3784.5
				J	338.1	-248.8	479.4	313.6	20724.8	-3600.3
			Min	I	-954.9	-547.0	-980.1	-2770.7	5584.6	-11751.5
				J	-955.3	-547.0	-898.6	-2847.5	5703.1	-11421.8
			INVSLEQP Max	I	-1170.5	-531.9	-28.4	-359.4	6795.7	-7006.6
				J	-1170.9	-531.9	18.1	-363.9	6801.3	-6660.6
			Min	I	-1248.7	-535.3	-31.8	-360.6	6694.9	-7170.1
				J	-1249.1	-535.3	14.6	-365.0	6698.2	-6826.3
			INVSLEF Max	I	21.6	-301.3	211.2	29.3	15648.6	-5120.8
				J	21.1	-301.3	275.1	-11.3	15786.5	-4918.8
			Min	I	-590.3	-432.1	-682.8	-1873.3	7243.7	-9007.0
				J	-590.7	-432.1	-615.5	-1922.6	7326.6	-8734.5
1128	2	102	INVSLE Max	I	692.7	-279.9	732.0	730.0	28333.5	-4413.8
				J	691.8	-279.9	816.4	657.1	28503.0	-4197.1
			Min	I	-1589.8	-747.0	-1245.9	-3644.6	3498.9	-15130.4
				J	-1590.2	-747.0	-1136.9	-3749.9	3524.0	-14722.5
			INVSLE Min	I	364.9	-121.2	132.2	191.0	12076.0	1328.3
				J	364.5	-121.2	178.5	186.6	12135.3	1465.9
			Min	I	-2078.6	-847.5	-200.6	-1016.1	2050.0	-14562.9
				J	-2079.0	-847.5	-154.3	-1020.6	2004.9	-14076.3
			INVSLE Max	I	342.7	-253.0	479.5	453.7	20750.0	-3601.2
				J	342.1	-253.0	554.1	398.5	20860.3	-3412.4
			Min	I	-951.5	-548.0	-898.7	-2652.7	5708.4	-11423.8
				J	-951.9	-548.0	-818.0	-2730.7	5796.9	-11096.0
			INVSLEQP Max	I	-1165.3	-544.1	17.4	-289.2	6805.4	-6662.7
				J	-1165.7	-544.1	63.7	-293.7	6781.5	-6309.3
			Min	I	-1243.4	-548.4	14.0	-289.3	6702.4	-6828.3
				J	-1243.8	-548.4	60.3	-293.8	6676.2	-6477.7
			INVSLEF Max	I	25.4	-305.4	275.1	115.7	15804.1	-4919.8
				J	24.9	-305.4	338.7	76.5	15890.0	-4714.3
			Min	I	-587.2	-433.0	-615.6	-1764.3	7330.3	-8736.1
				J	-587.7	-433.0	-548.7	-1814.3	7383.2	-8464.6
1129	2	102	INVSLE Max	I	1066.8	-335.2	656.1	132.1	28411.2	-5389.2
				J	1065.7	-335.2	740.6	56.7	28585.6	-5165.0
			Min	I	-1212.7	-873.1	-1308.2	-4249.0	3365.4	-16548.8
				J	-1213.3	-873.1	-1199.1	-4351.7	3450.6	-16054.5
			INVSLE Min	I	407.6	-129.5	120.7	68.6	11992.5	1023.7
				J	407.1	-129.5	166.7	64.2	12081.0	1150.6
			Min	I	-1631.5	-914.7	-264.5	-1606.8	1959.5	-15768.5
				J	-1632.0	-914.7	-218.5	-1611.2	1933.6	-15227.1
			INVSLE Max	I	616.5	-293.2	471.3	150.7	20792.3	-4279.3
				J	615.6	-293.2	545.9	110.7	20905.5	-4084.3
			Min	I	-696.8	-624.6	-942.7	-3090.8	5705.9	-12411.5
				J	-697.4	-624.6	-861.9	-3166.9	5804.0	-12021.4
			INVSLEQP Max	I	-987.0	-580.8	6.8	-510.3	6712.5	-7114.9
				J	-987.6	-580.8	52.8	-514.7	6693.4	-6742.6
			Min	I	-1058.1	-581.8	6.7	-527.5	6604.2	-7252.7
				J	-1058.7	-581.8	52.7	-532.0	6585.2	-6881.0
			INVSLEF Max	I	254.9	-343.5	274.3	-109.8	15822.6	-5510.1
				J	254.3	-343.5	337.9	-149.9	15906.7	-5284.7
			Min	I	-397.8	-494.1	-630.5	-2061.1	7309.6	-9403.6
				J	-398.3	-494.1	-564.0	-2109.3	7366.0	-9095.1
1130	2	102	INVSLE Max	I	1078.3	-337.8	740.7	408.7	28642.5	-5166.6
				J	1075.9	-337.8	826.2	331.4	28732.1	-4937.0
			Min	I	-1203.4	-873.1	-1198.8	-3923.7	3464.0	-16056.9
				J	-1204.0	-873.1	-1089.2	-4024.6	3520.5	-15571.8
			INVSLE Min	I	388.3	-117.3	143.6	110.1	12103.5	1156.4
				J	387.7	-117.3	189.6	105.6	12144.8	1272.0
			Min	I	-1594.7	-948.2	-196.5	-1397.3	1938.6	-15239.4

Sovrapasso di ingresso - Ponte strallato - Relazione di calcolo

			J	-1595.3	-948.2	-150.4	-1401.8	1901.7	-14672.6	
			INVSLE Max	I	625.8	-298.1	546.4	355.9	20947.0	-4085.9
				J	624.0	-298.1	621.7	314.9	20997.4	-3885.0
			Min	I	-690.7	-620.3	-861.8	-2854.1	5817.0	-12023.5
				J	-691.3	-620.3	-780.6	-2928.9	5886.0	-11638.4
			INVSLEQP Max	I	-977.4	-597.9	51.9	-390.5	6703.3	-6746.2
				J	-977.9	-597.9	98.0	-395.0	6655.3	-6361.7
			Min	I	-1048.4	-600.1	51.7	-409.8	6595.4	-6884.5
				J	-1049.0	-600.1	97.7	-414.2	6547.5	-6501.5
			INVSLEF Max	I	263.2	-347.4	338.2	73.8	15935.2	-5286.2
				J	261.8	-347.4	402.3	32.8	15970.8	-5057.4
			Min	I	-392.0	-492.0	-563.8	-1849.2	7375.1	-9096.6
				J	-392.5	-492.0	-496.8	-1896.5	7402.3	-8788.8
1131	2	102	INVSLE Max	I	1090.1	-339.8	826.5	748.0	28790.9	-4938.5
				J	1084.3	-339.8	902.2	678.9	28781.2	-4729.4
			Min	I	-1192.1	-874.2	-1088.8	-3590.5	3535.3	-15573.1
				J	-1192.7	-874.2	-991.9	-3679.3	3561.4	-15152.4
			INVSLE Min	I	370.6	-104.7	174.8	168.8	12167.3	1277.8
				J	370.0	-104.7	215.7	164.9	12164.3	1371.2
			Min	I	-1556.3	-985.1	-136.8	-1161.0	1906.8	-14685.5
				J	-1556.9	-985.1	-96.0	-1165.0	1864.9	-14159.6
			INVSLE Max	I	635.5	-302.9	622.4	602.6	21040.3	-3886.5
				J	631.2	-302.9	689.1	566.1	21019.1	-3702.2
			Min	I	-683.1	-616.0	-780.6	-2563.8	5899.4	-11639.8
				J	-683.7	-616.0	-708.8	-2630.6	5936.1	-11303.6
			INVSLEQP Max	I	-965.7	-617.8	96.9	-250.8	6664.6	-6365.8
				J	-966.2	-617.8	137.8	-254.7	6598.0	-6012.7
			Min	I	-1036.7	-621.4	96.6	-272.4	6557.3	-6505.5
				J	-1037.3	-621.4	137.4	-276.3	6490.8	-6154.4
			INVSLEF Max	I	272.0	-351.4	402.7	296.1	15999.6	-5059.0
				J	268.8	-351.4	459.3	259.5	15980.6	-4851.4
			Min	I	-385.0	-489.7	-496.7	-1592.4	7410.5	-8789.8
				J	-385.6	-489.7	-437.2	-1634.9	7410.2	-8519.9
1132	2	103	INVSLE Max	I	1082.2	-339.6	902.1	617.2	28770.7	-4729.2
				J	1077.4	-339.6	960.3	570.7	28732.5	-4553.2
			Min	I	-1194.5	-874.0	-992.0	-3737.0	3559.3	-15152.1
				J	-1194.9	-874.0	-924.4	-3802.6	3563.8	-14854.4
			INVSLE Min	I	352.4	-96.4	213.0	145.1	12159.2	1376.4
				J	352.0	-96.4	241.0	142.4	12134.7	1437.7
			Min	I	-1542.5	-989.9	-93.1	-1189.9	1866.2	-14163.8
				J	-1542.9	-989.9	-65.0	-1192.7	1831.5	-13789.9
			INVSLE Max	I	629.5	-302.3	689.0	523.7	21011.4	-3702.0
				J	625.9	-302.3	736.1	498.8	20973.2	-3572.5
			Min	I	-684.9	-616.6	-708.8	-2684.4	5934.2	-11303.3
				J	-685.3	-616.6	-658.8	-2733.7	5946.3	-11065.6
			INVSLEQP Max	I	-968.1	-614.8	137.9	-275.8	6596.7	-6012.1
				J	-968.5	-614.8	166.0	-278.5	6535.8	-5764.4
			Min	I	-1039.1	-618.3	137.6	-297.0	6489.5	-6153.9
				J	-1039.5	-618.3	165.7	-299.8	6428.7	-5907.5
			INVSLEF Max	I	267.3	-350.8	459.3	220.6	15975.3	-4851.2
				J	264.6	-350.8	499.0	195.8	15943.7	-4705.1
			Min	I	-386.7	-490.1	-437.3	-1679.7	7409.1	-8519.7
				J	-387.1	-490.1	-395.9	-1711.0	7395.0	-8329.0
1133	2	103	INVSLE Max	I	1077.3	-339.6	966.0	573.1	28732.6	-4553.1
				J	1075.0	-339.6	1029.5	528.6	28672.9	-4370.3
			Min	I	-1195.0	-874.0	-918.7	-3800.8	3563.9	-14854.4
				J	-1195.4	-874.0	-852.3	-3866.4	3555.5	-14556.7
			INVSLE Min	I	336.0	-88.0	244.1	136.3	12133.1	1442.6
				J	335.6	-88.0	272.1	133.5	12087.5	1499.4
			Min	I	-1527.1	-998.3	-59.6	-1183.0	1833.1	-13794.7
				J	-1527.5	-998.3	-31.5	-1185.8	1793.5	-13416.3
			INVSLE Max	I	625.9	-302.3	740.3	500.6	20973.2	-3572.4
				J	624.1	-302.3	787.4	476.7	20919.2	-3442.8
			Min	I	-685.4	-616.6	-654.5	-2731.9	5946.3	-11065.6
				J	-685.8	-616.6	-605.3	-2781.2	5945.4	-10827.9
			INVSLEQP Max	I	-968.5	-614.8	170.2	-276.8	6535.8	-5764.4
				J	-968.9	-614.8	198.3	-279.5	6462.0	-5516.6
			Min	I	-1039.6	-618.3	169.9	-298.0	6428.7	-5907.5
				J	-1040.0	-618.3	198.0	-300.8	6355.0	-5661.1
			INVSLEF Max	I	264.5	-350.8	503.2	197.6	15943.7	-4705.1
				J	263.2	-350.8	542.8	173.6	15899.3	-4558.9
			Min	I	-387.1	-490.1	-391.7	-1709.2	7395.1	-8329.0
				J	-387.5	-490.1	-350.9	-1740.3	7368.1	-8138.4
1134	2	102	INVSLE Max	I	1091.8	-338.6	1031.3	1087.6	28744.5	-4373.9
				J	1084.2	-338.6	1123.2	1020.1	28578.9	-4108.4
			Min	I	-1178.9	-876.4	-851.9	-3345.5	3574.3	-14558.6
				J	-1179.6	-876.4	-768.6	-3435.4	3544.0	-14152.0
			INVSLE Min	I	324.3	-76.9	272.1	237.4	12113.1	1504.4
				J	323.6	-76.9	312.7	233.5	12018.0	1577.9
			Min	I	-1486.4	-1041.5	-32.9	-890.1	1799.1	-13430.2

Sovrapasso di ingresso - Ponte strallato - Relazione di calcolo

			J	-1487.1	-1041.5	7.7	-894.0	1736.1	-12871.9	
			INVSLEP Max	I	638.0	-306.1	788.4	858.3	20971.5	-3444.6
				J	632.4	-306.1	856.5	822.4	20835.0	-3254.0
			Min	I	-674.7	-611.6	-605.3	-2296.1	5961.1	-10829.9
				J	-675.4	-611.6	-534.2	-2363.7	5940.8	-10502.2
			INVSLEQP Max	I	-952.1	-641.0	197.0	-93.4	6471.9	-5522.0
				J	-952.7	-641.0	237.6	-97.3	6349.1	-5156.8
			Min	I	-1023.0	-646.4	196.5	-117.8	6365.5	-5666.3
				J	-1023.6	-646.4	237.1	-121.7	6242.9	-5304.2
			INVSLEF Max	I	275.8	-355.5	543.4	524.8	15933.2	-4560.6
				J	271.6	-355.5	600.7	488.9	15824.5	-4348.7
			Min	I	-377.4	-487.3	-350.6	-1336.5	7376.0	-8139.7
				J	-378.0	-487.3	-291.4	-1379.4	7318.8	-7875.2
1135	2	102	INVSLEP Max	I	1084.7	-338.5	1123.3	1036.2	28580.8	-4108.5
				J	1080.7	-338.5	1229.4	968.3	28327.4	-3807.1
			Min	I	-1179.1	-876.5	-768.6	-3420.7	3544.6	-14152.0
				J	-1179.8	-876.5	-676.7	-3523.0	3482.5	-13691.5
			INVSLEF Max	I	302.6	-65.5	315.3	228.4	12016.4	1584.6
				J	301.8	-65.5	361.3	224.0	11863.8	1659.4
			Min	I	-1465.1	-1053.7	5.0	-877.6	1738.5	-12878.8
				J	-1465.8	-1053.7	51.1	-882.0	1656.3	-12236.4
			INVSLEP Max	I	632.7	-306.1	856.5	833.3	20836.4	-3254.0
				J	629.8	-306.1	935.2	796.9	20633.0	-3037.1
			Min	I	-675.0	-611.4	-534.2	-2349.9	5941.2	-10502.2
				J	-675.8	-611.4	-454.2	-2426.9	5884.8	-10130.9
			INVSLEQP Max	I	-952.2	-641.7	237.5	-92.0	6349.3	-5156.9
				J	-953.0	-641.7	283.6	-96.4	6182.3	-4742.2
			Min	I	-1023.2	-647.2	237.1	-116.5	6243.2	-5304.3
				J	-1023.9	-647.2	283.2	-121.0	6076.5	-4893.1
			INVSLEF Max	I	271.9	-355.6	600.7	499.0	15825.4	-4348.7
				J	269.7	-355.6	666.6	462.5	15664.3	-4108.0
			Min	I	-377.7	-487.2	-291.4	-1368.0	7318.9	-7875.2
				J	-378.4	-487.2	-224.5	-1416.4	7226.3	-7575.4
1136	2	102	INVSLEP Max	I	1090.1	-334.7	1230.6	1321.7	28379.1	-3809.2
				J	1088.5	-334.7	1336.3	1252.5	28027.1	-3501.8
			Min	I	-1169.0	-878.3	-676.9	-3200.4	3493.6	-13691.5
				J	-1169.8	-878.3	-585.3	-3305.1	3402.5	-13239.7
			INVSLEF Max	I	282.7	-52.5	365.7	300.0	11874.5	1666.7
				J	281.9	-52.5	411.9	295.6	11674.5	1733.0
			Min	I	-1427.5	-1086.6	45.8	-712.6	1661.1	-12249.1
				J	-1428.3	-1086.6	91.9	-717.0	1567.2	-11584.0
			INVSLEP Max	I	637.7	-306.2	935.9	1036.0	20671.0	-3038.1
				J	636.5	-306.2	1014.1	998.9	20394.6	-2814.5
			Min	I	-668.6	-608.5	-454.2	-2128.2	5889.6	-10131.3
				J	-669.3	-608.5	-374.3	-2206.9	5787.9	-9764.7
			INVSLEQP Max	I	-942.0	-658.1	282.8	15.8	6186.7	-4745.6
				J	-942.8	-658.1	328.9	11.4	5990.3	-4318.8
			Min	I	-1012.8	-664.7	282.3	-10.7	6081.2	-4896.3
				J	-1013.6	-664.7	328.4	-15.1	5885.1	-4473.8
			INVSLEF Max	I	277.1	-358.2	667.0	681.2	15688.9	-4108.8
				J	276.2	-358.2	732.4	644.2	15471.6	-3862.9
			Min	I	-371.9	-485.5	-224.3	-1166.0	7229.0	-7575.7
				J	-372.7	-485.5	-157.3	-1215.8	7106.8	-7278.5
1137	2	102	INVSLEP Max	I	1223.6	-346.4	1273.5	1242.1	28039.4	-4775.7
				J	1221.6	-346.4	1380.5	1166.9	27634.5	-4486.0
			Min	I	-610.7	-958.8	-808.5	-3929.9	3186.5	-13895.8
				J	-611.6	-958.8	-716.9	-4027.8	3206.8	-13381.6
			INVSLEF Max	I	440.2	-47.1	294.9	-41.8	11521.5	792.3
				J	439.3	-47.1	341.0	-46.2	11366.6	843.9
			Min	I	-898.2	-1129.8	-70.3	-1511.3	1452.7	-13608.9
				J	-899.2	-1129.8	-24.2	-1515.7	1434.3	-12906.4
			INVSLEP Max	I	784.9	-316.2	945.1	894.1	20382.6	-3938.8
				J	783.4	-316.2	1024.3	854.0	20081.6	-3735.2
			Min	I	-316.6	-674.8	-511.2	-2567.9	5644.3	-10432.5
				J	-317.5	-674.8	-431.4	-2641.5	5599.3	-10021.3
			INVSLEQP Max	I	-507.6	-678.8	140.3	-772.5	5810.4	-6240.5
				J	-508.5	-678.8	186.3	-777.0	5705.8	-5803.7
			Min	I	-568.0	-681.8	135.4	-820.6	5701.9	-6349.9
				J	-568.9	-681.8	181.5	-825.0	5600.4	-5914.9
			INVSLEF Max	I	454.7	-383.3	659.7	467.2	15422.9	-4909.0
				J	453.6	-383.3	725.9	427.0	15197.4	-4657.2
			Min	I	-116.5	-524.7	-257.7	-1470.9	6998.6	-7891.6
				J	-117.4	-524.7	-190.8	-1517.1	6912.1	-7568.3
1138	2	102	INVSLEP Max	I	1230.5	-341.5	1381.5	1421.8	27661.4	-4487.5
				J	1225.3	-341.5	1490.9	1346.0	27166.8	-4193.8
			Min	I	-602.9	-954.5	-716.6	-3808.1	3226.1	-13379.8
				J	-603.9	-954.5	-624.1	-3908.6	3216.9	-12869.7
			INVSLEF Max	I	419.7	-32.5	355.4	26.7	11379.0	851.3
				J	418.7	-32.5	401.8	22.3	11175.3	893.3
			Min	I	-864.7	-1150.2	-38.7	-1415.0	1445.7	-12918.3

Sovrapasso di ingresso - Ponte strallato - Relazione di calcolo

			J	-865.7	-1150.2	7.8	-1419.5	1414.6	-12195.8	
			INVSLEP Max	I	790.7	-314.1	1025.0	1025.5	20102.6	-3735.3
				J	786.8	-314.1	1106.0	984.9	19735.2	-3530.2
			Min	I	-312.0	-669.5	-431.1	-2437.8	5609.4	-10020.3
				J	-312.9	-669.5	-350.5	-2513.4	5534.2	-9611.1
			INVSLEQP Max	I	-500.0	-685.2	186.1	-699.1	5717.9	-5806.7
				J	-500.9	-685.2	232.5	-703.6	5582.5	-5361.3
			Min	I	-560.3	-689.0	181.2	-748.6	5613.0	-5917.8
				J	-561.2	-689.0	227.7	-753.1	5480.9	-5474.9
			INVSLEF Max	I	460.1	-381.8	726.3	582.9	15211.4	-4657.7
				J	457.1	-381.8	793.6	542.2	14938.3	-4402.8
			Min	I	-112.3	-521.0	-190.5	-1344.9	6918.2	-7567.6
				J	-113.2	-521.0	-122.7	-1392.3	6801.0	-7245.2
1139	2	102	INVSLEP Max	I	1234.9	-335.9	1492.1	1681.7	27193.7	-4195.5
				J	1225.7	-335.9	1587.4	1626.0	26689.3	-3939.0
			Min	I	-593.9	-949.8	-623.8	-3703.1	3238.1	-12868.1
				J	-594.8	-949.8	-543.9	-3794.0	3205.9	-12434.0
			INVSLEF Max	I	401.0	-18.8	417.9	112.9	11187.7	900.5
				J	400.1	-18.8	458.2	109.0	10972.4	929.1
			Min	I	-831.2	-1170.1	-8.3	-1318.2	1427.0	-12207.8
				J	-832.1	-1170.1	32.0	-1322.1	1389.8	-11569.3
			INVSLEP Max	I	794.8	-311.6	1106.8	1202.4	19756.4	-3530.3
				J	788.0	-311.6	1177.4	1171.9	19381.9	-3352.3
			Min	I	-306.7	-663.4	-350.2	-2316.0	5544.7	-9610.4
				J	-307.6	-663.4	-280.5	-2384.3	5455.2	-9260.6
			INVSLEQP Max	I	-491.2	-692.3	232.3	-618.0	5595.3	-5364.6
				J	-492.1	-692.3	272.6	-621.9	5453.6	-4973.5
			Min	I	-551.4	-697.0	227.4	-669.1	5494.3	-5478.1
				J	-552.3	-697.0	267.7	-673.0	5355.3	-5089.6
			INVSLEF Max	I	464.3	-380.1	794.1	742.9	14949.7	-4403.2
				J	459.1	-380.1	852.6	712.4	14661.6	-4181.0
			Min	I	-107.5	-516.8	-122.4	-1221.9	6806.9	-7244.5
				J	-108.4	-516.8	-63.6	-1265.2	6680.7	-6968.4
1140	2	103	INVSLEP Max	I	1230.3	-333.0	1588.0	1792.5	26702.0	-3939.8
				J	1223.4	-333.0	1655.8	1752.9	26270.5	-3755.6
			Min	I	-589.8	-947.4	-543.7	-3695.4	3216.4	-12433.1
				J	-590.5	-947.4	-487.2	-3761.8	3179.6	-12125.5
			INVSLEF Max	I	385.4	-9.1	472.0	156.0	10977.2	934.8
				J	384.7	-9.1	500.1	153.2	10801.3	951.3
			Min	I	-809.0	-1182.8	18.3	-1275.3	1396.6	-11577.3
				J	-809.6	-1182.8	46.4	-1278.1	1364.1	-11114.7
			INVSLEP Max	I	791.8	-310.3	1177.8	1278.8	19391.9	-3352.3
				J	786.7	-310.3	1228.1	1257.0	19071.7	-3224.3
			Min	I	-304.5	-660.4	-280.3	-2289.2	5460.1	-9260.2
				J	-305.1	-660.4	-231.2	-2339.1	5382.2	-9011.8
			INVSLEQP Max	I	-487.2	-695.8	272.5	-580.4	5459.6	-4975.2
				J	-487.8	-695.8	300.7	-583.2	5344.3	-4693.4
			Min	I	-547.4	-700.9	267.6	-632.2	5361.7	-5091.2
				J	-548.0	-700.9	295.7	-635.0	5248.4	-4811.5
			INVSLEF Max	I	462.6	-379.2	852.9	811.2	14665.0	-4181.2
				J	458.7	-379.2	894.3	789.3	14447.1	-4021.1
			Min	I	-105.5	-514.7	-63.4	-1182.5	6683.2	-6968.0
				J	-106.1	-514.7	-22.0	-1214.0	6579.1	-6771.7
1141	2	103	INVSLEP Max	I	1223.2	-333.0	1661.6	1755.3	26270.6	-3755.6
				J	1218.4	-333.0	1730.0	1717.3	25862.0	-3571.4
			Min	I	-590.6	-947.4	-483.0	-3760.1	3179.7	-12125.4
				J	-591.2	-947.4	-427.0	-3827.1	3129.9	-11818.0
			INVSLEF Max	I	369.2	-1.2	518.0	153.3	10799.5	956.6
				J	368.6	-1.2	546.2	150.5	10603.0	969.7
			Min	I	-794.3	-1190.7	37.1	-1274.6	1365.9	-11119.9
				J	-794.9	-1190.7	65.2	-1277.4	1327.9	-10653.8
			INVSLEP Max	I	786.6	-310.3	1232.3	1258.7	19071.7	-3224.2
				J	783.0	-310.3	1283.0	1237.6	18768.5	-3095.2
			Min	I	-305.2	-660.4	-226.9	-2337.3	5382.2	-9011.8
				J	-305.8	-660.4	-178.2	-2387.7	5291.3	-8763.6
			INVSLEQP Max	I	-487.9	-695.8	304.9	-581.4	5344.3	-4693.4
				J	-488.5	-695.8	333.1	-584.2	5216.1	-4411.6
			Min	I	-548.1	-700.9	300.0	-633.2	5248.4	-4811.5
				J	-548.7	-700.9	328.1	-635.9	5122.2	-4531.8
			INVSLEF Max	I	458.6	-379.2	898.5	791.1	14447.2	-4021.1
				J	455.9	-379.2	940.1	770.0	14212.2	-3860.0
			Min	I	-106.2	-514.7	-17.7	-1212.3	6579.1	-6771.7
				J	-106.8	-514.7	23.5	-1243.9	6462.0	-6575.4
1142	2	102	INVSLEP Max	I	1228.8	-325.8	1731.4	2116.2	25864.7	-3573.3
				J	1218.1	-325.8	1828.4	2143.7	25227.0	-3315.4
			Min	I	-578.8	-941.3	-426.6	-3591.6	3155.3	-11815.4
				J	-579.8	-941.3	-347.7	-3685.5	3067.1	-11398.7
			INVSLEF Max	I	356.6	9.7	561.2	275.1	10615.4	975.9
				J	355.7	9.7	601.4	271.2	10312.2	988.6
			Min	I	-762.3	-1208.7	50.2	-1179.0	1342.2	-10665.6

Sovrapasso di ingresso - Ponte strallato - Relazione di calcolo

			J	-763.2	-1208.7	90.4	-1182.9	1281.1	-10008.0	
			INVSLE Max	I	791.8	-307.0	1283.9	1493.1	18772.2	-3095.1
				J	783.9	-307.0	1355.8	1492.9	18299.1	-2915.7
			Min	I	-298.1	-652.8	-177.8	-2160.7	5302.7	-8762.2
				J	-299.1	-652.8	-108.9	-2231.2	5157.2	-8424.0
			INVSLEQP Max	I	-476.5	-704.2	332.9	-486.3	5230.0	-4415.7
				J	-477.4	-704.2	373.0	-490.2	5032.7	-4018.5
			Min	I	-536.5	-710.4	327.8	-539.9	5137.0	-4535.7
				J	-537.5	-710.4	368.0	-543.8	4942.4	-4142.0
			INVSLEF Max	I	464.0	-376.9	940.8	1006.6	14215.6	-3860.4
				J	458.0	-376.9	999.8	975.4	13849.3	-3635.2
			Min	I	-99.8	-509.3	24.0	-1046.6	6467.1	-6574.3
				J	-100.7	-509.3	82.5	-1090.9	6285.1	-6306.1
1143	2	102	INVSLE Max	I	1223.7	-321.6	1829.3	2379.0	25225.6	-3316.5
				J	1219.3	-321.6	1943.0	2356.7	24399.9	-3017.9
			Min	I	-572.7	-937.8	-347.4	-3555.4	3081.3	-11396.9
				J	-573.8	-937.8	-256.9	-3664.6	2951.8	-10923.4
			INVSLE Min	I	338.0	21.0	620.5	345.2	10316.6	996.1
				J	336.9	21.0	666.9	340.7	9923.0	1004.0
			Min	I	-733.8	-1223.9	71.3	-1133.5	1290.6	-10018.6
				J	-734.9	-1223.9	117.6	-1138.0	1207.8	-9250.6
			INVSLE Max	I	788.7	-305.0	1356.3	1663.3	18299.0	-2915.6
				J	785.4	-305.0	1440.6	1646.8	17686.5	-2700.0
			Min	I	-294.7	-648.5	-108.7	-2105.6	5163.1	-8423.1
				J	-295.8	-648.5	-29.6	-2187.6	4967.4	-8037.5
			INVSLEQP Max	I	-470.4	-709.0	372.9	-436.5	5040.1	-4020.8
				J	-471.6	-709.0	419.3	-440.9	4784.5	-3559.1
			Min	I	-530.5	-715.7	367.9	-491.1	4950.3	-4144.2
				J	-531.6	-715.7	414.2	-495.5	4698.0	-3686.8
			INVSLEF Max	I	462.5	-375.5	1000.2	1106.9	13849.6	-3635.4
				J	460.0	-375.5	1069.1	1108.4	13375.6	-3374.1
			Min	I	-96.7	-506.2	82.7	-981.6	6287.3	-6305.3
				J	-97.8	-506.2	150.2	-1033.1	6049.2	-5999.0
1144	2	102	INVSLE Max	I	1222.4	-319.0	1943.5	2492.8	24401.2	-3018.6
				J	1220.1	-319.0	2057.8	2472.3	23478.6	-2718.0
			Min	I	-569.5	-935.7	-256.8	-3589.6	2960.3	-10922.4
				J	-570.6	-935.7	-166.6	-3703.6	2800.1	-10451.0
			INVSLE Min	I	317.2	32.0	687.4	385.6	9924.1	1011.9
				J	316.0	32.0	734.0	381.1	9482.1	1013.7
			Min	I	-708.1	-1237.2	97.2	-1111.9	1214.7	-9260.2
				J	-709.2	-1237.2	143.7	-1116.4	1117.8	-8480.9
			INVSLE Max	I	788.1	-303.8	1440.9	1745.2	17688.1	-2700.2
				J	786.3	-303.8	1525.6	1730.0	17003.8	-2468.5
			Min	I	-293.1	-645.9	-29.5	-2115.2	4970.8	-8036.9
				J	-294.2	-645.9	49.4	-2200.8	4744.0	-7652.3
			INVSLEQP Max	I	-467.4	-711.8	419.2	-410.4	4788.7	-3560.5
				J	-468.5	-711.8	465.8	-414.8	4501.9	-3094.5
			Min	I	-527.3	-718.9	414.1	-465.5	4702.6	-3688.2
				J	-528.5	-718.9	460.7	-470.0	4419.0	-3226.8
			INVSLEF Max	I	462.5	-374.7	1069.4	1186.6	13377.0	-3374.2
				J	461.1	-374.7	1138.5	1169.0	12847.5	-3110.2
			Min	I	-95.4	-504.3	150.4	-969.9	6050.4	-5998.5
				J	-96.6	-504.3	217.9	-1023.6	5781.0	-5692.7
1145	2	102	INVSLE Max	I	1064.8	-297.1	2039.3	2653.2	23508.9	-4180.2
				J	1061.2	-297.1	2153.3	2628.3	22510.9	-3967.3
			Min	I	170.8	-962.0	-410.3	-4521.8	2534.0	-10364.0
				J	169.6	-962.0	-323.0	-4629.8	2531.3	-9792.1
			INVSLE Min	I	603.0	75.8	587.2	-111.5	9321.9	-558.4
				J	601.7	75.8	633.0	-115.9	8947.0	-594.9
			Min	I	-75.3	-1220.9	-91.1	-2248.3	932.8	-10880.0
				J	-76.5	-1220.9	-45.3	-2252.7	962.7	-10114.7
			INVSLE Max	I	778.9	-279.9	1468.0	1661.5	16985.4	-3450.3
				J	776.2	-279.9	1552.5	1643.0	16273.3	-3260.5
			Min	I	157.5	-674.6	-101.5	-2695.8	4566.5	-7811.3
				J	156.2	-674.6	-25.0	-2776.9	4431.8	-7414.1
			INVSLEQP Max	I	261.8	-658.7	157.9	-1758.9	4217.6	-6314.1
				J	260.6	-658.7	203.7	-1763.3	4102.5	-5893.1
			Min	I	215.7	-661.5	147.8	-1839.1	4131.2	-6386.0
				J	214.4	-661.5	193.6	-1843.5	4022.5	-5966.8
			INVSLEF Max	I	576.4	-365.1	1056.6	932.8	12783.2	-4222.7
				J	574.3	-365.1	1125.2	912.8	12256.3	-3988.5
			Min	I	237.5	-508.9	99.5	-1425.3	5640.8	-6072.4
				J	236.2	-508.9	165.3	-1476.5	5438.6	-5770.0
1146	2	102	INVSLE Max	I	1069.1	-289.8	2154.3	2893.6	22503.1	-3964.5
				J	1059.6	-289.8	2271.6	2867.7	21385.8	-3750.3
			Min	I	178.0	-953.0	-322.3	-4482.0	2565.5	-9793.2
				J	176.7	-953.0	-233.2	-4593.9	2532.3	-9217.2
			INVSLE Min	I	583.8	90.8	652.6	-20.4	8959.8	-586.9
				J	582.4	90.8	699.3	-24.9	8531.3	-633.5
			Min	I	-44.1	-1228.7	-64.2	-2209.1	987.3	-10127.4

Sovrapasso di ingresso - Ponte strallato - Relazione di calcolo

			J	-45.4	-1228.7	-17.5	-2213.6	1002.9	-9341.3		
			INVSLE	Max	I	782.8	-274.7	1553.3	1834.6	16271.4	-3259.2
					J	775.7	-274.7	1640.1	1815.5	15471.4	-3067.3
				Min	I	161.1	-667.1	-24.4	-2634.3	4449.4	-7412.8
					J	159.8	-667.1	53.7	-2718.3	4281.7	-7014.1
			INVSLEQP	Max	I	269.0	-655.2	204.1	-1704.4	4128.5	-5896.8
					J	267.7	-655.2	250.8	-1708.8	3980.6	-5468.8
				Min	I	222.9	-658.6	194.0	-1785.7	4049.6	-5970.4
					J	221.6	-658.6	240.7	-1790.2	3908.3	-5544.6
			INVSLEF	Max	I	580.1	-360.7	1125.8	1064.0	12258.1	-3988.1
					J	574.8	-360.7	1196.1	1043.0	11663.8	-3751.6
				Min	I	241.1	-503.0	165.8	-1352.1	5448.4	-5768.6
					J	239.8	-503.0	233.2	-1405.0	5211.6	-5465.0
1147	2	102	INVSLE	Max	I	1067.8	-281.9	2272.7	3147.4	21374.2	-3747.3
					J	1054.7	-281.9	2374.0	3124.4	20331.2	-3566.0
				Min	I	185.8	-943.2	-232.3	-4440.7	2568.9	-9218.9
					J	184.6	-943.2	-156.4	-4542.9	2515.9	-8731.3
			INVSLE	Max	I	567.3	104.9	717.9	76.3	8543.9	-625.7
					J	566.1	104.9	758.0	72.4	8139.2	-673.1
				Min	I	-14.8	-1234.7	-35.1	-2170.6	1029.1	-9354.0
					J	-16.0	-1234.7	5.1	-2174.5	1030.0	-8675.8
			INVSLE	Max	I	782.6	-268.9	1641.0	2017.8	15467.1	-3065.9
					J	772.9	-268.9	1716.0	2000.7	14718.2	-2901.7
				Min	I	164.9	-659.0	54.3	-2571.1	4300.1	-7013.1
					J	163.7	-659.0	121.0	-2647.8	4131.5	-6676.8
			INVSLEQP	Max	I	276.7	-651.2	251.4	-1647.3	4008.2	-5472.8
					J	275.5	-651.2	291.5	-1651.2	3856.6	-5106.8
				Min	I	230.7	-655.3	241.2	-1729.8	3936.9	-5548.5
					J	229.5	-655.3	281.3	-1733.6	3791.0	-5184.8
			INVSLEF	Max	I	580.9	-355.8	1196.8	1200.7	11664.1	-3751.1
					J	573.6	-355.8	1257.3	1182.1	11106.1	-3550.2
				Min	I	245.0	-496.6	233.8	-1277.0	5221.4	-5463.9
					J	243.8	-496.6	291.6	-1325.6	4993.5	-5207.9
1148	2	103	INVSLE	Max	I	1058.5	-278.2	2374.5	3252.2	20325.9	-3564.6
					J	1050.4	-278.2	2446.8	3235.2	19530.6	-3435.6
				Min	I	188.9	-938.4	-156.0	-4472.6	2533.3	-8732.2
					J	188.1	-938.4	-102.2	-4548.5	2481.5	-8385.1
			INVSLE	Max	I	553.8	113.8	772.3	120.5	8143.9	-667.1
					J	552.9	113.8	800.4	117.8	7833.1	-666.3
				Min	I	3.7	-1239.8	-8.7	-2156.5	1043.3	-8684.1
					J	2.8	-1239.8	19.3	-2159.3	1036.7	-8233.6
			INVSLE	Max	I	776.1	-266.2	1716.4	2093.2	14716.4	-2901.0
					J	770.1	-266.2	1769.9	2080.6	14144.3	-2782.9
				Min	I	166.2	-655.1	121.2	-2580.6	4140.2	-6676.4
					J	165.3	-655.1	168.4	-2637.5	4005.4	-6437.5
			INVSLEQP	Max	I	279.8	-649.3	291.7	-1622.9	3869.5	-5108.7
					J	279.0	-649.3	319.8	-1625.6	3746.9	-4846.7
				Min	I	233.8	-653.7	281.5	-1705.7	3804.4	-5186.6
					J	233.0	-653.7	309.6	-1708.5	3685.9	-4926.4
			INVSLEF	Max	I	576.5	-353.4	1257.6	1253.9	11106.4	-3550.0
					J	571.9	-353.4	1300.5	1240.3	10679.2	-3406.6
				Min	I	246.2	-493.5	291.8	-1267.3	4997.9	-5207.4
					J	245.4	-493.5	332.7	-1303.4	4820.6	-5025.5
1149	2	103	INVSLE	Max	I	1050.2	-278.2	2452.5	3237.6	19530.6	-3435.5
					J	1042.8	-278.2	2525.3	3221.7	18706.8	-3289.8
				Min	I	187.9	-938.4	-97.9	-4546.7	2481.6	-8385.0
					J	187.1	-938.4	-45.0	-4623.3	2416.8	-8055.7
			INVSLE	Max	I	539.5	119.8	817.8	121.9	7831.3	-660.4
					J	538.6	119.8	845.9	119.1	7501.6	-652.6
				Min	I	16.0	-1245.8	10.4	-2159.8	1038.6	-8239.4
					J	15.2	-1245.8	38.5	-2162.6	1025.0	-7795.9
			INVSLE	Max	I	769.9	-266.2	1774.2	2082.4	14144.4	-2782.8
					J	764.4	-266.2	1828.0	2070.6	13551.2	-2664.6
				Min	I	165.2	-655.1	172.6	-2635.7	4005.4	-6437.4
					J	164.4	-655.1	219.1	-2693.1	3857.7	-6199.3
			INVSLEQP	Max	I	278.8	-649.3	324.1	-1623.8	3746.9	-4846.6
					J	278.0	-649.3	352.1	-1626.6	3611.4	-4584.6
				Min	I	232.8	-653.7	313.9	-1706.7	3686.0	-4926.3
					J	232.0	-653.7	341.9	-1709.5	3554.5	-4666.1
			INVSLEF	Max	I	571.8	-353.4	1304.8	1242.1	10679.3	-3406.5
					J	567.6	-353.4	1347.9	1228.9	10235.4	-3263.2
				Min	I	245.3	-493.5	336.9	-1301.6	4820.6	-5025.4
					J	244.4	-493.5	377.4	-1337.9	4630.3	-4844.0
1150	2	102	INVSLE	Max	I	1052.3	-267.3	2526.8	3552.6	18685.3	-3291.1
					J	1039.4	-267.3	2631.1	3527.1	17448.3	-3043.6
				Min	I	199.2	-924.7	-43.9	-4438.0	2465.8	-8053.2
					J	197.9	-924.7	32.1	-4548.1	2354.8	-7646.4
			INVSLE	Max	I	533.2	132.3	860.6	243.7	7517.0	-646.3
					J	532.0	132.3	901.2	239.8	7024.1	-639.7
				Min	I	41.0	-1246.9	25.1	-2113.0	1059.3	-7808.8

Sovrapasso di ingresso - Ponte strallato - Relazione di calcolo

			J	39.8	-1246.9	65.6	-2116.9	1029.1	-7186.1	
			INVSLE Max	I	772.5	-258.3	1829.2	2310.3	13541.2	-2662.7
				J	763.0	-258.3	1906.4	2291.4	12648.8	-2498.7
			Min	I	171.2	-643.8	219.9	-2516.6	3881.6	-6198.4
				J	169.9	-643.8	286.7	-2599.2	3653.9	-5872.3
			INVSLEQP Max	I	290.0	-643.6	352.8	-1551.4	3647.5	-4589.9
				J	288.7	-643.6	393.4	-1555.3	3436.7	-4223.6
			Min	I	244.1	-648.9	342.6	-1635.4	3592.1	-4671.2
				J	242.8	-648.9	383.1	-1639.3	3387.1	-4307.8
			INVSLEF Max	I	575.0	-346.6	1348.8	1415.3	10232.6	-3262.6
				J	567.8	-346.6	1410.7	1395.0	9563.8	-3064.0
			Min	I	251.2	-484.5	378.1	-1185.1	4642.1	-4842.7
				J	250.0	-484.5	436.5	-1237.4	4354.4	-4594.1
1151	2	102	INVSLE Max	I	1043.2	-262.5	2631.7	3665.2	17437.1	-3044.2
				J	1040.2	-262.5	2752.5	3636.9	15937.5	-2763.1
			Min	I	202.0	-918.5	32.5	-4470.0	2376.5	-7645.4
				J	200.6	-918.5	118.6	-4598.6	2221.7	-7188.0
			INVSLE Min	I	521.1	142.3	918.4	295.1	7028.5	-631.7
				J	519.6	142.3	964.7	290.7	6426.3	-625.9
			Min	I	59.8	-1251.7	49.0	-2099.0	1046.1	-7197.0
				J	58.3	-1251.7	95.3	-2103.4	995.1	-6488.2
			INVSLE Max	I	766.3	-254.7	1906.9	2391.4	12643.2	-2497.8
				J	764.1	-254.7	1996.4	2370.5	11559.8	-2311.9
			Min	I	172.9	-638.7	287.0	-2525.0	3664.2	-5871.9
				J	171.5	-638.7	362.7	-2621.4	3376.3	-5504.9
			INVSLEQP Max	I	294.0	-641.0	393.7	-1523.4	3452.5	-4225.9
				J	292.6	-641.0	440.0	-1527.9	3183.9	-3809.3
			Min	I	248.2	-646.7	383.5	-1607.9	3403.6	-4310.1
				J	246.7	-646.7	429.7	-1612.4	3141.6	-3897.1
			INVSLEF Max	I	570.9	-343.5	1411.1	1472.8	9561.7	-3063.7
				J	569.1	-343.5	1482.4	1449.9	8748.1	-2838.8
			Min	I	253.0	-480.5	436.8	-1173.4	4359.2	-4593.5
				J	251.5	-480.5	503.3	-1234.3	4002.8	-4313.5
1152	2	102	INVSLE Max	I	1047.2	-253.2	2753.7	3875.8	15916.1	-2764.3
				J	1044.0	-253.2	2873.4	3845.7	14316.0	-2487.2
			Min	I	207.0	-906.6	119.5	-4461.7	2262.6	-7186.4
				J	205.5	-906.6	204.1	-4595.9	2078.9	-6743.6
			INVSLE Min	I	515.0	154.3	982.3	385.8	6435.6	-617.3
				J	513.5	154.3	1028.3	381.4	5795.7	-613.0
			Min	I	79.9	-1253.6	78.8	-2070.1	1025.4	-6502.3
				J	78.4	-1253.6	124.8	-2074.5	956.1	-5802.8
			INVSLE Max	I	770.2	-247.9	1997.3	2543.7	11549.1	-2310.4
				J	767.8	-247.9	2086.0	2521.4	10391.0	-2128.0
			Min	I	177.1	-628.9	363.4	-2491.9	3395.5	-5504.4
				J	175.6	-628.9	438.0	-2592.5	3079.5	-5148.2
			INVSLEQP Max	I	302.6	-635.9	440.6	-1471.8	3213.4	-3813.7
				J	301.1	-635.9	486.7	-1476.2	2916.5	-3402.4
			Min	I	256.8	-642.4	430.3	-1557.1	3172.4	-3901.4
				J	255.3	-642.4	476.3	-1561.5	2882.0	-3494.2
			INVSLEF Max	I	574.8	-337.6	1483.2	1584.9	8744.2	-2838.4
				J	573.0	-337.6	1553.7	1560.8	7873.0	-2618.2
			Min	I	257.1	-472.7	503.9	-1122.7	4011.4	-4312.7
				J	255.6	-472.7	569.7	-1186.5	3627.3	-4041.1
1153	2	102	INVSLE Max	I	539.1	-254.3	2907.9	3959.7	14471.0	-1583.3
				J	527.7	-254.3	3032.3	3928.5	12737.0	-1391.1
			Min	I	71.3	-956.0	227.1	-4454.5	2141.0	-5044.5
				J	69.7	-956.0	311.9	-4588.1	1908.9	-4492.3
			INVSLE Min	I	391.9	157.4	1074.7	458.4	5873.6	-314.9
				J	390.3	157.4	1121.2	454.0	5165.3	-310.8
			Min	I	32.3	-1274.2	125.5	-2044.2	1010.1	-5395.2
				J	30.7	-1274.2	172.1	-2048.7	910.9	-4676.4
			INVSLE Max	I	409.7	-249.3	2111.7	2604.4	10507.9	-1342.1
				J	401.3	-249.3	2203.9	2581.3	9250.9	-1161.3
			Min	I	51.7	-666.1	460.4	-2521.9	3140.5	-3710.3
				J	50.1	-666.1	535.3	-2622.0	2775.4	-3330.4
			INVSLEQP Max	I	249.9	-644.2	510.5	-1421.2	2986.5	-3186.0
				J	248.3	-644.2	557.0	-1425.6	2640.8	-2767.5
			Min	I	202.1	-646.5	500.4	-1507.2	2955.6	-3286.5
				J	200.5	-646.5	546.9	-1511.7	2616.5	-2869.4
			INVSLEF Max	I	310.9	-348.4	1579.5	1624.1	7961.6	-1977.4
				J	304.5	-348.4	1652.4	1599.4	7010.0	-1750.4
			Min	I	140.0	-491.1	592.0	-1107.4	3685.8	-2856.6
				J	138.4	-491.1	658.2	-1170.6	3252.3	-2572.4
1154	2	102	INVSLE Max	I	541.5	-246.7	3033.3	4177.5	12700.9	-1387.2
				J	523.7	-246.7	3157.0	4140.8	10872.4	-1199.1
			Min	I	77.7	-944.9	313.0	-4438.8	1961.6	-4496.9
				J	76.0	-944.9	397.3	-4577.5	1702.0	-3963.4
			INVSLE Min	I	397.5	167.0	1136.3	557.1	5175.2	-301.8
				J	395.8	167.0	1182.3	552.7	4435.6	-294.2
			Min	I	46.0	-1273.4	158.4	-2012.3	950.2	-4693.1

Sovrapasso di ingresso - Ponte strallato - Relazione di calcolo

			J	44.4	-1273.4	204.4	-2016.7	831.3	-3992.5	
			INVSLE Max	I	412.5	-243.3	2204.7	2762.1	9231.1	-1159.5
				J	399.3	-243.3	2296.3	2734.9	7903.7	-981.0
			Min	I	55.0	-658.4	535.9	-2482.3	2800.0	-3330.7
				J	53.3	-658.4	610.3	-2586.2	2409.1	-2964.7
			INVSLEQP Max	I	261.5	-638.2	557.8	-1363.8	2678.6	-2773.4
				J	259.9	-638.2	603.8	-1368.3	2306.7	-2362.7
			Min	I	213.8	-641.6	547.6	-1450.5	2656.0	-2875.2
				J	212.1	-641.6	593.6	-1455.0	2290.6	-2466.7
			INVSLEF Max	I	312.7	-343.5	1653.1	1740.7	7001.0	-1750.1
				J	302.7	-343.5	1725.4	1712.9	5995.2	-1528.1
			Min	I	145.6	-485.2	658.8	-1051.0	3262.0	-2571.9
				J	143.9	-485.2	724.8	-1116.8	2803.4	-2297.8
1155	2	102	INVSLE Max	I	525.6	-245.5	3157.2	4171.8	10866.9	-1198.6
				J	514.8	-245.5	3267.0	4141.8	9183.9	-1033.2
			Min	I	77.2	-943.2	397.5	-4558.6	1709.7	-3964.2
				J	75.7	-943.2	461.1	-4687.3	1456.6	-3498.3
			INVSLE Min	I	399.6	173.3	1193.9	568.4	4434.6	-286.0
				J	398.2	173.3	1234.4	564.5	3752.8	-268.0
			Min	I	43.8	-1278.1	193.0	-2014.8	839.3	-4001.9
				J	42.4	-1278.1	233.5	-2018.7	716.2	-3397.2
			INVSLE Max	I	400.9	-242.4	2296.4	2757.5	7900.7	-980.8
				J	392.8	-242.4	2377.8	2735.3	6677.8	-822.1
			Min	I	54.0	-657.2	610.4	-2568.6	2412.6	-2964.9
				J	52.6	-657.2	668.0	-2664.9	2044.0	-2645.6
			INVSLEQP Max	I	261.8	-637.3	603.9	-1360.4	2312.2	-2363.6
				J	260.3	-637.3	644.4	-1364.3	1960.2	-2002.4
			Min	I	214.1	-640.8	593.8	-1447.2	2296.3	-2467.6
				J	212.6	-640.8	634.3	-1451.0	1950.0	-2108.3
			INVSLEF Max	I	303.9	-342.7	1725.5	1730.5	5993.8	-1528.1
				J	296.4	-342.7	1789.5	1707.1	5066.3	-1324.7
			Min	I	144.9	-484.3	724.9	-1101.7	2804.8	-2297.8
				J	143.5	-484.3	777.3	-1162.8	2376.5	-2058.0
1156	2	103	INVSLE Max	I	523.7	-238.9	3267.9	4293.6	9153.0	-1030.7
				J	515.6	-238.9	3344.3	4267.6	7890.1	-875.3
			Min	I	82.4	-933.2	461.9	-4593.3	1501.4	-3503.8
				J	81.4	-933.2	492.3	-4687.8	1288.2	-3176.9
			INVSLE Min	I	425.7	179.4	1243.1	629.5	3759.7	-261.8
				J	424.6	179.4	1271.4	626.7	3254.5	-236.1
			Min	I	33.8	-1274.8	226.0	-1995.6	750.0	-3410.7
				J	32.7	-1274.8	254.3	-1998.3	650.6	-2994.3
			INVSLE Max	I	400.3	-237.2	2378.5	2845.6	6660.9	-821.1
				J	394.2	-237.2	2435.1	2826.3	5742.4	-677.7
			Min	I	56.6	-650.3	668.4	-2577.5	2063.8	-2647.2
				J	55.6	-650.3	698.3	-2648.2	1767.3	-2449.2
			INVSLEQP Max	I	271.5	-631.9	645.2	-1324.9	1991.9	-2007.8
				J	270.4	-631.9	673.4	-1327.7	1725.7	-1751.0
			Min	I	223.9	-636.3	634.9	-1412.0	1983.3	-2113.6
				J	222.8	-636.3	663.2	-1414.8	1721.2	-1858.5
			INVSLEF Max	I	302.7	-338.3	1790.1	1793.6	5058.7	-1325.2
				J	296.7	-338.3	1834.4	1774.2	4361.7	-1168.3
			Min	I	149.4	-479.1	777.8	-1088.2	2384.1	-2058.5
				J	148.4	-479.1	806.7	-1133.0	2053.6	-1890.4
1157	2	103	INVSLE Max	I	515.4	-238.9	3350.1	4270.0	7890.1	-875.2
				J	510.9	-238.9	3428.8	4246.9	6600.9	-706.7
			Min	I	81.2	-933.2	496.5	-4686.0	1288.2	-3176.8
				J	80.2	-933.2	526.6	-4785.2	1040.2	-2924.8
			INVSLE Min	I	432.0	183.5	1282.1	630.4	3252.4	-230.1
				J	431.0	183.5	1310.3	627.6	2732.0	-178.4
			Min	I	25.0	-1278.8	252.1	-1998.5	652.8	-3000.1
				J	24.0	-1278.8	280.3	-2001.2	542.3	-2609.8
			INVSLE Max	I	394.1	-237.2	2439.4	2828.1	5742.5	-677.6
				J	390.8	-237.2	2497.7	2810.9	4804.5	-519.7
			Min	I	55.4	-650.3	702.5	-2646.4	1767.3	-2449.1
				J	54.4	-650.3	732.1	-2720.7	1445.6	-2261.3
			INVSLEQP Max	I	270.3	-631.9	677.7	-1325.9	1725.8	-1750.9
				J	269.2	-631.9	705.9	-1328.7	1446.4	-1494.1
			Min	I	222.6	-636.3	667.5	-1413.0	1721.3	-1858.5
				J	221.6	-636.3	695.7	-1415.7	1446.0	-1603.5
			INVSLEF Max	I	296.5	-338.3	1838.7	1776.0	4361.8	-1168.2
				J	293.2	-338.3	1884.2	1758.1	3649.2	-1005.6
			Min	I	148.2	-479.1	810.9	-1131.2	2053.6	-1890.3
				J	147.2	-479.1	839.7	-1178.4	1697.8	-1722.8
1158	2	102	INVSLE Max	I	519.7	-231.9	3429.7	4357.5	6569.1	-705.2
				J	517.1	-231.9	3538.4	4318.0	4714.8	-474.9
			Min	I	87.0	-922.6	527.4	-4714.3	1073.5	-2927.0
				J	85.5	-922.6	569.4	-4852.5	694.5	-2623.7
			INVSLE Min	I	462.6	188.7	1317.1	676.9	2738.0	-174.1
				J	461.1	188.7	1357.1	673.0	1998.8	-23.4
			Min	I	11.6	-1273.8	274.9	-1983.5	577.5	-2622.3

Sovrapasso di ingresso - Ponte strallato - Relazione di calcolo

			J	10.0	-1273.8	314.9	-1987.4	407.3	-2168.6		
		INVSLEP	Max	I	398.1	-231.7	2498.4	2891.5	4787.3	-519.4	
				J	396.2	-231.7	2578.9	2862.2	3438.0	-298.9	
			Min	I	58.5	-642.9	732.5	-2655.1	1458.5	-2263.8	
				J	56.9	-642.9	774.0	-2758.5	982.3	-2011.1	
		INVSLEQP	Max	I	280.6	-626.0	706.7	-1298.5	1480.0	-1499.8	
				J	279.0	-626.0	746.7	-1302.4	1080.8	-1148.2	
			Min	I	233.0	-631.4	696.4	-1385.7	1478.9	-1609.1	
				J	231.5	-631.4	736.5	-1389.5	1073.9	-1260.4	
		INVSLEF	Max	I	299.4	-333.6	1884.8	1821.4	3641.7	-1006.4	
				J	297.5	-333.6	1947.7	1792.4	2616.8	-779.9	
			Min	I	153.2	-473.5	840.2	-1122.5	1697.1	-1724.2	
				J	151.7	-473.5	880.8	-1188.0	1171.2	-1497.8	
1159	2	102	INVSLEP	Max	I	518.2	-231.0	3538.5	4327.9	4710.8	-474.7
				J	515.2	-231.0	3667.9	4304.5	2485.2	-63.5	
			Min	I	86.4	-921.2	569.5	-4845.9	698.8	-2624.1	
				J	84.6	-921.2	617.4	-5017.9	229.1	-2298.0	
		INVSLEQP	Max	I	477.1	193.6	1362.8	679.3	1996.7	-17.9	
				J	475.2	193.6	1409.3	674.8	1112.7	275.3	
			Min	I	-3.5	-1277.5	309.4	-1987.3	414.6	-2175.1	
				J	-5.3	-1277.5	356.0	-1991.8	184.9	-1766.4	
		INVSLEF	Max	I	397.1	-231.0	2579.0	2869.4	3435.9	-298.9	
				J	394.9	-231.0	2674.8	2852.1	1814.6	-22.8	
			Min	I	57.4	-642.0	774.0	-2752.5	983.5	-2011.5	
				J	51.5	-642.0	821.6	-2881.0	387.9	-1735.8	
		INVSLEQP	Max	I	280.5	-625.3	746.8	-1299.5	1085.1	-1148.9	
				J	278.7	-625.3	793.4	-1304.0	592.8	-740.4	
			Min	I	233.0	-630.7	736.5	-1386.7	1078.1	-1261.1	
				J	231.2	-630.7	783.1	-1391.1	579.1	-856.2	
		INVSLEF	Max	I	298.3	-333.0	1947.8	1798.0	2615.9	-780.0	
				J	296.1	-333.0	2022.4	1776.5	1377.6	-511.5	
			Min	I	152.4	-472.7	880.8	-1182.8	1171.0	-1498.1	
				J	146.5	-472.7	927.8	-1264.3	532.3	-1236.8	
1160	2	102	INVSLEP	Max	I	525.0	-222.7	3668.8	4351.1	2455.1	-69.0
				J	522.5	-222.7	3795.7	4336.2	231.7	353.3	
			Min	I	92.4	-908.4	618.3	-4986.2	267.4	-2302.2	
				J	90.4	-908.4	664.9	-5164.3	-388.4	-2053.3	
		INVSLEQP	Max	I	517.5	198.9	1414.2	698.4	1118.0	275.5	
				J	515.7	198.9	1460.3	693.9	299.5	856.4	
			Min	I	-25.6	-1270.4	352.7	-1983.7	227.2	-1777.5	
				J	-27.5	-1270.4	398.8	-1988.2	-117.6	-1671.2	
		INVSLEF	Max	I	403.1	-224.4	2675.6	2886.2	1799.5	-24.5	
				J	401.1	-224.4	2769.6	2875.1	178.2	295.8	
			Min	I	55.7	-633.1	822.1	-2852.2	397.0	-1739.9	
				J	52.1	-633.1	868.5	-2985.2	-277.2	-1526.6	
		INVSLEQP	Max	I	291.6	-618.1	794.3	-1289.4	632.0	-747.7	
				J	289.8	-618.1	840.4	-1293.8	114.3	-347.1	
			Min	I	244.2	-624.7	783.9	-1376.4	616.6	-863.3	
				J	242.4	-624.7	830.0	-1380.8	92.1	-466.9	
		INVSLEF	Max	I	303.1	-327.4	2023.1	1803.6	1371.3	-513.4	
				J	301.1	-327.4	2096.1	1786.7	101.3	-242.9	
			Min	I	152.9	-466.0	928.3	-1239.6	530.4	-1240.2	
				J	149.3	-466.0	974.5	-1324.0	-154.8	-987.8	
1161	2	102	INVSLEP	Max	I	30.3	0.0	-40.2	1208.4	-11.1	12.6
				J	0.2	0.0	-4.3	-1.8	-0.0	-0.1	
			Min	I	1.6	-0.0	-756.0	-285.0	-359.1	0.1	
				J	0.2	-0.0	-5.8	-2.4	-0.1	-0.1	
		INVSLEQP	Max	I	13.8	11.0	-33.2	5.5	-6.8	6.7	
				J	12.3	11.0	2.7	2.1	2.8	5.0	
			Min	I	-10.5	-11.0	-47.1	-2.2	-15.5	-6.6	
				J	-12.0	-11.0	-11.2	-5.7	-2.8	-5.2	
		INVSLEF	Max	I	22.5	0.0	-40.2	895.1	-11.1	9.3	
				J	0.2	0.0	-4.3	-1.8	-0.0	-0.1	
			Min	I	1.6	-0.0	-560.0	-210.7	-266.0	0.1	
				J	0.2	-0.0	-4.3	-1.8	-0.0	-0.1	
		INVSLEQP	Max	I	1.6	0.0	-40.2	1.7	-11.1	0.1	
				J	0.2	0.0	-4.3	-1.8	-0.0	-0.1	
			Min	I	1.6	0.0	-40.2	1.7	-11.1	0.1	
				J	0.2	0.0	-4.3	-1.8	-0.0	-0.1	
		INVSLEF	Max	I	17.0	0.0	-40.2	658.3	-11.1	0.1	
				J	0.2	0.0	-4.3	-1.8	-0.0	-0.1	
			Min	I	1.6	-0.0	-423.0	-151.5	-200.5	0.1	
				J	0.2	-0.0	-4.3	-1.8	-0.0	-0.1	
1163	14	100	INVSLEP	Max	I	2324.9	118.1	365.7	210.3	1495.3	-1764.0
				J	2557.0	13.9	365.9	210.3	810.2	-1914.8	
			Min	I	-9053.3	-627.9	-562.1	-32.7	-1556.5	-12163.9	
				J	-8882.9	-706.0	-559.7	-32.7	-389.8	-10560.6	
		INVSLEQP	Max	I	2679.4	414.8	192.4	167.9	1069.9	350.1	
				J	2851.3	340.1	192.4	167.9	863.2	-441.4	
			Min	I	-8389.3	-923.9	-244.6	-173.4	-1036.7	-13576.6	

Sovrapasso di ingresso - Ponte strallato - Relazione di calcolo

			J	-8217.4	-998.6	-244.6	-173.4	-704.7	-11379.2	
			INVSLE Max	I	1600.0	29.2	196.0	170.6	1051.9	-2213.3
				J	1771.9	-47.8	194.4	170.6	627.4	-2184.8
			Min	I	-6605.3	-365.2	-430.8	113.6	-1161.7	-7740.5
				J	-6433.5	-437.6	-429.2	113.6	-171.6	-6774.9
			INVSLEQP Max	I	-2784.7	-366.0	-110.0	145.1	5.1	-8326.6
				J	-2612.8	-440.7	-110.0	145.1	269.2	-7356.1
			Min	I	-2829.0	-381.1	-141.7	135.4	-78.7	-8547.6
				J	-2657.1	-455.8	-141.7	135.4	261.6	-7540.7
			INVSLEF Max	I	14.7	0.9	60.9	156.4	573.6	-2569.1
				J	186.6	-74.5	60.9	156.4	429.5	-2478.7
			Min	I	-4472.7	-187.5	-286.0	130.9	-681.5	-5272.4
				J	-4300.8	-262.2	-286.0	130.9	4.4	-4730.8
1166	2	84	INVSLE Max	I	391.4	25.1	53.4	0.1	26.8	13.3
				J	391.4	25.1	54.2	0.1	26.8	10.2
			Min	I	54.1	-19.6	-54.1	-0.1	-27.2	-9.6
				J	54.1	-19.9	-53.2	-0.1	-27.2	-11.9
			INVSLE Min	I	127.1	11.3	27.3	0.2	13.7	5.8
				J	127.1	11.3	27.9	0.2	14.3	5.7
			Min	I	0.7	-11.0	-29.1	-0.2	-14.5	-5.3
				J	0.7	-11.0	-28.5	-0.2	-13.9	-5.5
			INVSLE Max	I	326.2	18.9	39.2	0.1	19.7	10.1
				J	326.2	18.9	39.8	0.1	19.8	6.5
			Min	I	274.5	-11.8	-40.0	-0.1	-20.1	-5.3
				J	274.5	-11.8	-39.4	-0.1	-20.1	-8.9
			INVSLEQP Max	I	334.3	3.4	-1.0	0.0	-0.4	2.4
				J	334.3	3.4	-0.4	0.0	0.3	-1.0
			Min	I	329.1	3.4	-1.0	0.0	-0.6	2.4
				J	329.1	3.4	-0.4	0.0	0.0	-1.0
			INVSLEF Max	I	304.6	11.8	20.8	0.1	10.5	6.5
				J	304.6	11.8	21.4	0.1	10.6	3.0
			Min	I	278.9	-4.7	-21.5	-0.0	-10.9	-1.8
				J	278.9	-4.7	-20.9	-0.0	-10.8	-5.3
1167	2	84	INVSLE Max	I	73.8	25.1	56.2	0.1	28.3	13.3
				J	73.8	25.1	57.0	0.1	27.7	10.2
			Min	I	-15.9	-19.6	-55.9	-0.1	-28.1	-9.6
				J	-15.9	-19.9	-55.1	-0.1	-28.7	-11.9
			INVSLE Min	I	30.8	11.3	28.3	0.2	14.3	5.8
				J	30.8	11.3	28.9	0.2	14.6	5.7
			Min	I	-38.3	-11.0	-29.6	-0.2	-14.7	-5.3
				J	-38.3	-11.0	-29.0	-0.2	-14.4	-5.5
			INVSLE Max	I	59.5	18.9	41.4	0.1	20.8	10.1
				J	59.5	18.9	42.0	0.1	20.5	6.5
			Min	I	42.5	-11.8	-41.3	-0.1	-20.8	-5.3
				J	42.5	-11.8	-40.7	-0.1	-21.2	-8.9
			INVSLEQP Max	I	46.1	3.4	-0.6	0.0	-0.2	2.4
				J	46.1	3.4	0.0	0.0	0.1	-1.0
			Min	I	42.9	3.4	-0.6	0.0	-0.4	2.4
				J	42.9	3.4	-0.0	0.0	-0.2	-1.0
			INVSLEF Max	I	56.6	11.8	22.3	0.1	11.2	6.5
				J	56.6	11.8	22.9	0.1	10.9	3.0
			Min	I	47.8	-4.7	-22.3	-0.0	-11.2	-1.8
				J	47.8	-4.7	-21.7	-0.0	-11.6	-5.3
1169	14	95	INVSLE Max	I	2665.4	227.1	543.8	-1.3	2024.8	-1405.9
				J	2929.3	109.0	532.3	-1.3	799.0	-1806.2
			Min	I	-10132.1	-520.6	-425.8	-232.6	-2168.2	-13281.9
				J	-9938.3	-609.0	-425.9	-232.6	-1330.1	-11923.6
			INVSLE Min	I	2492.7	553.0	256.7	205.3	1094.6	1281.4
				J	2688.0	468.2	256.7	205.3	829.7	201.9
			Min	I	-8939.8	-885.5	-256.3	-234.9	-1245.7	-15495.4
				J	-8744.5	-970.4	-256.3	-234.9	-981.6	-13409.4
			INVSLE Max	I	1812.1	107.5	410.2	-143.7	1497.0	-2113.2
				J	2007.6	20.3	402.5	-143.7	536.7	-2264.2
			Min	I	-7488.9	-277.1	-258.0	-188.2	-1611.9	-8376.0
				J	-7293.7	-359.6	-250.3	-188.2	-1017.7	-7609.5
			INVSLEQP Max	I	-3292.2	-288.2	83.0	-165.1	-22.1	-9163.6
				J	-3096.9	-373.0	83.0	-165.1	-221.5	-8367.5
			Min	I	-3365.7	-301.6	77.4	-165.9	-117.3	-9421.3
				J	-3170.4	-386.5	77.4	-165.9	-303.2	-8593.0
			INVSLEF Max	I	-8.1	79.1	253.0	-157.8	823.6	-2518.8
				J	187.2	-6.6	253.0	-157.8	216.4	-2603.8
			Min	I	-5123.5	-100.2	-99.0	-172.8	-905.1	-5534.5
				J	-4928.1	-185.1	-99.0	-172.8	-668.3	-5189.9
1171	14	99	INVSLE Max	I	2859.4	240.0	628.9	-20.7	2311.3	-1356.9
				J	3123.1	121.8	626.6	-20.7	1035.3	-1786.6
			Min	I	-10023.4	-529.0	-307.1	-357.4	-1827.7	-13287.5
				J	-9829.6	-617.4	-306.9	-357.4	-1251.8	-11909.8
			INVSLE Min	I	2802.1	563.5	340.3	181.6	1359.9	1423.7
				J	2997.4	478.6	340.3	181.6	884.9	308.4
			Min	I	-8880.3	-894.7	-201.4	-282.4	-1009.5	-15668.9

Sovrapasso di ingresso - Ponte strallato - Relazione di calcolo

			J	-8684.9	-979.6	-201.4	-282.4	-868.2	-13550.3	
			INVSLEP Max	I	2002.8	119.4	486.9	-179.1	1750.7	-2072.1
				J	2198.1	32.2	485.4	-179.1	594.6	-2249.8
			Min	I	-7352.1	-273.1	-160.4	-292.4	-1319.0	-8312.8
				J	-7156.7	-355.7	-158.8	-292.4	-948.6	-7556.4
			INVSLEQP Max	I	-2941.2	-274.7	200.4	-241.8	352.3	-9121.4
				J	-2745.8	-359.6	200.4	-241.8	-129.0	-8357.7
			Min	I	-2993.5	-288.7	196.2	-265.0	273.2	-9367.9
				J	-2798.2	-373.6	196.2	-265.0	-198.1	-8570.7
			INVSLEF Max	I	173.8	90.2	323.3	-199.4	1038.0	-2481.0
				J	369.1	4.6	323.3	-199.4	261.7	-2592.7
			Min	I	-4975.9	-94.7	-21.1	-259.2	-663.9	-5471.4
				J	-4780.6	-179.6	-21.1	-259.2	-614.6	-5140.6
1174	2	85	INVSLEP Max	I	56.2	0.1	-0.1	0.0	0.0	0.0
				J	57.1	0.7	0.3	0.0	0.0	0.0
			Min	I	-1145.2	-0.7	-0.3	0.0	0.0	0.0
				J	-1143.7	-0.1	0.1	0.0	0.0	0.0
			INVSLEF Max	I	49.2	-0.3	-0.2	0.0	0.0	0.0
				J	50.2	0.3	0.2	0.0	0.0	0.0
			Min	I	-286.0	-0.3	-0.2	0.0	0.0	0.0
				J	-284.9	0.3	0.2	0.0	0.0	0.0
			INVSLEP Max	I	-514.1	-0.1	-0.2	0.0	0.0	0.0
				J	-513.0	0.4	0.3	0.0	0.0	0.0
			Min	I	-933.0	-0.4	-0.3	0.0	0.0	0.0
				J	-932.0	0.1	0.2	0.0	0.0	0.0
			INVSLEQP Max	I	-754.2	-0.3	-0.2	0.0	0.0	0.0
				J	-753.1	0.3	0.2	0.0	0.0	0.0
			Min	I	-782.5	-0.3	-0.2	0.0	0.0	0.0
				J	-781.5	0.3	0.2	0.0	0.0	0.0
			INVSLEF Max	I	-587.5	-0.2	-0.2	0.0	0.0	0.0
				J	-586.4	0.3	0.2	0.0	0.0	0.0
			Min	I	-820.6	-0.3	-0.2	0.0	0.0	0.0
				J	-819.5	0.2	0.2	0.0	0.0	0.0
1177	2	85	INVSLEP Max	I	168.4	0.7	-0.1	0.0	0.0	0.0
				J	169.2	0.2	0.4	0.0	0.0	0.0
			Min	I	-1271.3	-0.2	-0.4	0.0	0.0	0.0
				J	-1269.9	-0.7	0.1	0.0	0.0	0.0
			INVSLEF Max	I	91.5	0.3	-0.2	0.0	0.0	0.0
				J	92.6	-0.3	0.2	0.0	0.0	0.0
			Min	I	-356.6	0.3	-0.2	0.0	0.0	0.0
				J	-355.5	-0.3	0.2	0.0	0.0	0.0
			INVSLEP Max	I	-442.9	0.5	-0.2	0.0	0.0	0.0
				J	-441.8	-0.1	0.3	0.0	0.0	0.0
			Min	I	-1027.2	0.1	-0.3	0.0	0.0	0.0
				J	-1026.1	-0.5	0.2	0.0	0.0	0.0
			INVSLEQP Max	I	-779.7	0.3	-0.2	0.0	0.0	0.0
				J	-778.6	-0.3	0.2	0.0	0.0	0.0
			Min	I	-796.1	0.3	-0.2	0.0	0.0	0.0
				J	-795.0	-0.3	0.2	0.0	0.0	0.0
			INVSLEF Max	I	-555.9	0.3	-0.2	0.0	0.0	0.0
				J	-554.9	-0.2	0.2	0.0	0.0	0.0
			Min	I	-875.1	0.2	-0.2	0.0	0.0	0.0
				J	-874.0	-0.3	0.2	0.0	0.0	0.0
1178	2	85	INVSLEP Max	I	266.7	0.2	-0.1	0.0	0.0	0.0
				J	267.6	0.7	0.4	0.0	0.0	0.0
			Min	I	-1353.1	-0.7	-0.4	0.0	0.0	0.0
				J	-1351.7	-0.2	0.1	0.0	0.0	0.0
			INVSLEF Max	I	151.0	-0.3	-0.2	0.0	0.0	0.0
				J	152.0	0.3	0.2	0.0	0.0	0.0
			Min	I	-409.6	-0.3	-0.2	0.0	0.0	0.0
				J	-408.5	0.3	0.2	0.0	0.0	0.0
			INVSLEP Max	I	-366.2	-0.1	-0.2	0.0	0.0	0.0
				J	-365.2	0.5	0.3	0.0	0.0	0.0
			Min	I	-1084.8	-0.5	-0.3	0.0	0.0	0.0
				J	-1083.7	0.1	0.2	0.0	0.0	0.0
			INVSLEQP Max	I	-763.3	-0.3	-0.2	0.0	0.0	0.0
				J	-762.2	0.3	0.2	0.0	0.0	0.0
			Min	I	-776.7	-0.3	-0.2	0.0	0.0	0.0
				J	-775.6	0.3	0.2	0.0	0.0	0.0
			INVSLEF Max	I	-509.8	-0.2	-0.2	0.0	0.0	0.0
				J	-508.7	0.3	0.2	0.0	0.0	0.0
			Min	I	-902.3	-0.3	-0.2	0.0	0.0	0.0
				J	-901.2	0.2	0.2	0.0	0.0	0.0
1181	2	85	INVSLEP Max	I	313.3	0.7	-0.1	0.0	0.0	0.0
				J	314.2	0.2	0.4	0.0	0.0	0.0
			Min	I	-1401.0	-0.2	-0.4	0.0	0.0	0.0
				J	-1399.6	-0.7	0.1	0.0	0.0	0.0
			INVSLEF Max	I	195.5	0.3	-0.2	0.0	0.0	0.0
				J	196.6	-0.3	0.2	0.0	0.0	0.0
			Min	I	-477.8	0.3	-0.2	0.0	0.0	0.0

Sovrapasso di ingresso - Ponte strallato - Relazione di calcolo

			J	-476.8	-0.3	0.2	0.0	0.0	0.0
			INVSLE Max	I	-322.9	0.5	-0.2	0.0	0.0
				J	-321.8	-0.1	0.3	0.0	0.0
			Min	I	-1121.3	0.1	-0.3	0.0	0.0
				J	-1120.2	-0.5	0.2	0.0	0.0
			INVSLEQP Max	I	-770.7	0.3	-0.2	0.0	0.0
				J	-769.6	-0.3	0.2	0.0	0.0
			Min	I	-783.5	0.3	-0.2	0.0	0.0
				J	-782.5	-0.3	0.2	0.0	0.0
			INVSLEF Max	I	-483.1	0.3	-0.2	0.0	0.0
				J	-482.0	-0.2	0.2	0.0	0.0
			Min	I	-923.1	0.2	-0.2	0.0	0.0
				J	-922.0	-0.3	0.2	0.0	0.0
1182	2	85	INVSLE Max	I	362.8	0.2	-0.1	0.0	0.0
				J	363.7	0.8	0.4	-0.0	0.0
			Min	I	-1349.1	-0.8	-0.4	0.0	0.0
				J	-1347.7	-0.2	0.1	-0.0	0.0
			INVSLE Min	I	290.4	-0.3	-0.2	0.0	0.0
				J	291.4	0.3	0.2	0.0	0.0
			Min	I	-520.8	-0.3	-0.2	0.0	0.0
				J	-519.7	0.3	0.2	-0.0	0.0
			INVSLE Max	I	-254.4	-0.1	-0.2	0.0	0.0
				J	-253.4	0.5	0.3	-0.0	0.0
			Min	I	-1074.7	-0.5	-0.3	0.0	0.0
				J	-1073.6	0.1	0.2	-0.0	0.0
			INVSLEQP Max	I	-694.1	-0.3	-0.2	0.0	0.0
				J	-693.0	0.3	0.2	-0.0	0.0
			Min	I	-709.0	-0.3	-0.2	0.0	0.0
				J	-707.9	0.3	0.2	-0.0	0.0
			INVSLEF Max	I	-419.3	-0.2	-0.2	0.0	0.0
				J	-418.2	0.3	0.2	-0.0	0.0
			Min	I	-876.5	-0.3	-0.2	0.0	0.0
				J	-875.4	0.2	0.2	-0.0	0.0
1185	2	85	INVSLE Max	I	296.0	0.8	-0.1	0.0	0.0
				J	296.8	0.2	0.4	0.0	0.0
			Min	I	-1143.8	-0.2	-0.4	0.0	0.0
				J	-1142.4	-0.8	0.1	0.0	0.0
			INVSLE Min	I	319.1	0.3	-0.2	0.0	0.0
				J	320.2	-0.3	0.2	0.0	0.0
			Min	I	-517.5	0.3	-0.2	0.0	0.0
				J	-516.4	-0.3	0.2	0.0	0.0
			INVSLE Max	I	-249.2	0.5	-0.2	0.0	0.0
				J	-248.1	-0.1	0.3	0.0	0.0
			Min	I	-917.8	0.1	-0.3	0.0	0.0
				J	-916.7	-0.5	0.2	0.0	0.0
			INVSLEQP Max	I	-628.8	0.3	-0.2	0.0	0.0
				J	-627.7	-0.3	0.2	0.0	0.0
			Min	I	-642.7	0.3	-0.2	0.0	0.0
				J	-641.6	-0.3	0.2	0.0	0.0
			INVSLEF Max	I	-384.8	0.3	-0.2	0.0	0.0
				J	-383.7	-0.2	0.2	0.0	0.0
			Min	I	-760.4	0.2	-0.2	0.0	0.0
				J	-759.3	-0.3	0.2	0.0	0.0
1186	2	85	INVSLE Max	I	117.1	0.2	-0.1	0.0	0.0
				J	118.0	0.8	0.4	0.0	0.0
			Min	I	-804.8	-0.8	-0.4	0.0	0.0
				J	-803.3	-0.2	0.1	0.0	0.0
			INVSLE Min	I	301.7	-0.3	-0.2	0.0	0.0
				J	302.8	0.3	0.2	0.0	0.0
			Min	I	-423.8	-0.3	-0.2	0.0	0.0
				J	-422.8	0.3	0.2	0.0	0.0
			INVSLE Max	I	-302.7	-0.1	-0.2	0.0	0.0
				J	-301.6	0.5	0.3	0.0	0.0
			Min	I	-652.5	-0.5	-0.3	0.0	0.0
				J	-651.4	0.1	0.2	0.0	0.0
			INVSLEQP Max	I	-503.5	-0.3	-0.2	0.0	0.0
				J	-502.4	0.3	0.2	0.0	0.0
			Min	I	-519.2	-0.3	-0.2	0.0	0.0
				J	-518.1	0.3	0.2	0.0	0.0
			INVSLEF Max	I	-375.3	-0.2	-0.2	0.0	0.0
				J	-374.2	0.3	0.2	0.0	0.0
			Min	I	-567.2	-0.3	-0.2	0.0	0.0
				J	-566.1	0.2	0.2	0.0	0.0
1189	2	85	INVSLE Max	I	102.0	0.8	-0.1	0.0	0.0
				J	102.8	0.3	0.4	0.0	0.0
			Min	I	-603.8	-0.3	-0.4	0.0	0.0
				J	-602.3	-0.8	0.1	0.0	0.0
			INVSLE Min	I	217.3	0.3	-0.2	0.0	0.0
				J	218.3	-0.3	0.2	0.0	0.0
			Min	I	-252.6	0.3	-0.2	0.0	0.0

Sovrapasso di ingresso - Ponte strallato - Relazione di calcolo

			J	-251.5	-0.3	0.2	0.0	0.0	0.0
			INVSLE Max	I	-249.8	0.5	-0.2	0.0	0.0
				J	-248.7	-0.1	0.3	0.0	0.0
			Min	I	-492.0	0.1	-0.3	0.0	0.0
				J	-490.9	-0.5	0.2	0.0	0.0
			INVSLEQP Max	I	-388.4	0.3	-0.2	0.0	0.0
				J	-387.3	-0.3	0.2	0.0	0.0
			Min	I	-404.5	0.3	-0.2	0.0	0.0
				J	-403.4	-0.3	0.2	0.0	0.0
			INVSLEF Max	I	-308.3	0.3	-0.2	0.0	0.0
				J	-307.2	-0.2	0.2	0.0	0.0
			Min	I	-434.7	0.2	-0.2	0.0	0.0
				J	-433.6	-0.3	0.2	0.0	0.0
1190	2	85	INVSLE Max	I	125.0	0.3	-0.1	0.0	0.0
				J	125.7	0.9	0.4	0.0	0.0
			Min	I	-492.5	-0.9	-0.4	0.0	0.0
				J	-491.1	-0.3	0.1	0.0	0.0
			INVSLE Min	I	74.2	-0.3	-0.2	0.0	0.0
				J	75.3	0.3	0.2	0.0	0.0
			Min	I	-127.8	-0.3	-0.2	0.0	0.0
				J	-126.7	0.3	0.2	0.0	0.0
			INVSLE Max	I	-129.8	-0.0	-0.2	0.0	0.0
				J	-128.7	0.5	0.3	0.0	0.0
			Min	I	-399.0	-0.5	-0.3	0.0	0.0
				J	-397.9	0.0	0.2	0.0	0.0
			INVSLEQP Max	I	-289.5	-0.3	-0.2	0.0	0.0
				J	-288.4	0.3	0.2	0.0	0.0
			Min	I	-302.8	-0.3	-0.2	0.0	0.0
				J	-301.7	0.3	0.2	0.0	0.0
			INVSLEF Max	I	-192.0	-0.2	-0.2	0.0	0.0
				J	-190.9	0.4	0.2	0.0	0.0
			Min	I	-338.4	-0.4	-0.2	0.0	0.0
				J	-337.3	0.2	0.2	0.0	0.0
1193	2	85	INVSLE Max	I	358.5	0.7	-0.1	0.0	0.0
				J	359.4	0.2	0.3	0.0	0.0
			Min	I	-483.5	-0.2	-0.3	0.0	0.0
				J	-482.1	-0.7	0.1	0.0	0.0
			INVSLE Min	I	230.5	0.3	-0.2	0.0	0.0
				J	231.6	-0.3	0.2	0.0	0.0
			Min	I	-152.0	0.3	-0.2	0.0	0.0
				J	-150.9	-0.3	0.2	-0.0	0.0
			INVSLE Max	I	147.0	0.4	-0.2	0.0	0.0
				J	148.1	-0.1	0.3	0.0	0.0
			Min	I	-366.5	0.1	-0.3	0.0	0.0
				J	-365.4	-0.4	0.2	0.0	0.0
			INVSLEQP Max	I	-69.9	0.3	-0.2	0.0	0.0
				J	-68.9	-0.3	0.2	0.0	0.0
			Min	I	-98.8	0.3	-0.2	0.0	0.0
				J	-97.7	-0.3	0.2	0.0	0.0
			INVSLEF Max	I	23.2	0.3	-0.2	0.0	0.0
				J	24.3	-0.2	0.2	0.0	0.0
			Min	I	-263.8	0.2	-0.2	0.0	0.0
				J	-262.8	-0.3	0.2	0.0	0.0
1194	2	85	INVSLE Max	I	497.3	0.2	-0.1	0.0	0.0
				J	498.1	0.7	0.3	0.0	0.0
			Min	I	-570.3	-0.7	-0.3	0.0	0.0
				J	-568.8	-0.2	0.1	0.0	0.0
			INVSLE Min	I	311.6	-0.3	-0.2	0.0	0.0
				J	312.7	0.3	0.2	0.0	0.0
			Min	I	-209.2	-0.3	-0.2	0.0	0.0
				J	-208.1	0.3	0.2	0.0	0.0
			INVSLE Max	I	257.3	-0.1	-0.2	0.0	0.0
				J	258.3	0.4	0.3	0.0	0.0
			Min	I	-425.9	-0.4	-0.3	0.0	0.0
				J	-424.9	0.1	0.2	0.0	0.0
			INVSLEQP Max	I	-38.5	-0.3	-0.2	0.0	0.0
				J	-37.4	0.3	0.2	0.0	0.0
			Min	I	-58.0	-0.3	-0.2	0.0	0.0
				J	-56.9	0.3	0.2	0.0	0.0
			INVSLEF Max	I	93.9	-0.2	-0.2	0.0	0.0
				J	95.0	0.3	0.2	0.0	0.0
			Min	I	-283.1	-0.3	-0.2	0.0	0.0
				J	-282.0	0.2	0.2	0.0	0.0
1197	2	85	INVSLE Max	I	591.7	0.7	-0.1	0.0	0.0
				J	592.6	0.2	0.4	0.0	0.0
			Min	I	-653.8	-0.2	-0.4	0.0	0.0
				J	-652.4	-0.7	0.1	0.0	0.0
			INVSLE Min	I	391.2	0.3	-0.2	0.0	0.0
				J	392.3	-0.3	0.2	0.0	0.0
			Min	I	-291.9	0.3	-0.2	0.0	0.0

Sovrapasso di ingresso - Ponte strallato - Relazione di calcolo

			J	-290.8	-0.3	0.2	-0.0	0.0	0.0
			INVSLE Max	I	322.0	0.4	-0.2	0.0	0.0
				J	323.1	-0.1	0.3	0.0	0.0
			Min	I	-489.9	0.1	-0.3	0.0	0.0
				J	-488.8	-0.4	0.2	0.0	0.0
			INVSLEQP Max	I	-49.9	0.3	-0.2	0.0	0.0
				J	-48.9	-0.3	0.2	0.0	0.0
			Min	I	-65.8	0.3	-0.2	0.0	0.0
				J	-64.7	-0.3	0.2	0.0	0.0
			INVSLEF Max	I	129.9	0.3	-0.2	0.0	0.0
				J	131.0	-0.2	0.2	0.0	0.0
			Min	I	-319.5	0.2	-0.2	0.0	0.0
				J	-318.5	-0.3	0.2	0.0	0.0
1198	2	85	INVSLE Max	I	646.3	0.2	-0.1	0.0	0.0
				J	647.1	0.7	0.4	-0.0	0.0
			Min	I	-718.7	-0.7	-0.4	0.0	0.0
				J	-717.2	-0.2	0.1	-0.0	0.0
			INVSLE Min	I	478.0	-0.3	-0.2	0.0	0.0
				J	479.1	0.3	0.2	0.0	0.0
			Min	I	-364.5	-0.3	-0.2	0.0	0.0
				J	-363.5	0.3	0.2	-0.0	0.0
			INVSLE Max	I	348.0	-0.1	-0.2	0.0	0.0
				J	349.1	0.5	0.3	-0.0	0.0
			Min	I	-537.1	-0.5	-0.3	0.0	0.0
				J	-536.1	0.1	0.2	-0.0	0.0
			INVSLEQP Max	I	-45.0	-0.3	-0.2	0.0	0.0
				J	-43.9	0.3	0.2	-0.0	0.0
			Min	I	-61.7	-0.3	-0.2	0.0	0.0
				J	-60.6	0.3	0.2	-0.0	0.0
			INVSLEF Max	I	143.7	-0.2	-0.2	0.0	0.0
				J	144.8	0.3	0.2	-0.0	0.0
			Min	I	-350.5	-0.3	-0.2	0.0	0.0
				J	-349.5	0.2	0.2	-0.0	0.0
1201	2	85	INVSLE Max	I	639.2	0.7	-0.1	0.0	0.0
				J	640.1	0.2	0.4	0.0	0.0
			Min	I	-731.1	-0.2	-0.4	0.0	0.0
				J	-729.9	-0.7	0.1	0.0	0.0
			INVSLE Min	I	548.5	0.3	-0.2	0.0	0.0
				J	549.6	-0.3	0.2	0.0	0.0
			Min	I	-440.3	0.3	-0.2	0.0	0.0
				J	-439.3	-0.3	0.2	0.0	0.0
			INVSLE Max	I	320.9	0.5	-0.2	0.0	0.0
				J	322.1	-0.1	0.3	0.0	0.0
			Min	I	-551.2	0.1	-0.3	0.0	0.0
				J	-550.2	-0.5	0.2	0.0	0.0
			INVSLEQP Max	I	-78.2	0.3	-0.2	0.0	0.0
				J	-77.1	-0.3	0.2	0.0	0.0
			Min	I	-94.0	0.3	-0.2	0.0	0.0
				J	-92.9	-0.3	0.2	0.0	0.0
			INVSLEF Max	I	119.6	0.3	-0.2	0.0	0.0
				J	120.7	-0.2	0.2	0.0	0.0
			Min	I	-368.7	0.2	-0.2	0.0	0.0
				J	-367.7	-0.3	0.2	0.0	0.0
1202	2	85	INVSLE Max	I	491.3	0.2	-0.1	0.0	0.0
				J	492.1	0.8	0.4	0.0	0.0
			Min	I	-648.4	-0.8	-0.4	0.0	0.0
				J	-647.0	-0.2	0.1	0.0	0.0
			INVSLE Min	I	555.9	-0.3	-0.2	0.0	0.0
				J	557.0	0.3	0.2	0.0	0.0
			Min	I	-450.7	-0.3	-0.2	0.0	0.0
				J	-449.6	0.3	0.2	0.0	0.0
			INVSLE Max	I	192.7	-0.1	-0.2	0.0	0.0
				J	193.7	0.5	0.3	0.0	0.0
			Min	I	-490.9	-0.5	-0.3	0.0	0.0
				J	-489.8	0.1	0.2	0.0	0.0
			INVSLEQP Max	I	-101.5	-0.3	-0.2	0.0	0.0
				J	-100.4	0.3	0.2	0.0	0.0
			Min	I	-118.1	-0.3	-0.2	0.0	0.0
				J	-117.0	0.3	0.2	0.0	0.0
			INVSLEF Max	I	32.6	-0.2	-0.2	0.0	0.0
				J	33.7	0.3	0.2	0.0	0.0
			Min	I	-344.0	-0.3	-0.2	0.0	0.0
				J	-342.9	0.2	0.2	0.0	0.0
1205	2	85	INVSLE Max	I	219.4	0.8	-0.1	0.0	0.0
				J	220.2	0.3	0.4	0.0	0.0
			Min	I	-429.2	-0.3	-0.4	0.0	0.0
				J	-427.7	-0.8	0.1	0.0	0.0
			INVSLE Min	I	469.0	0.3	-0.2	0.0	0.0
				J	470.1	-0.3	0.2	0.0	0.0
			Min	I	-381.8	0.3	-0.2	0.0	0.0

Sovrapasso di ingresso - Ponte strallato - Relazione di calcolo

			J	-380.7	-0.3	0.2	0.0	0.0	0.0
			INVSLE Max	I	-30.1	0.5	-0.2	0.0	0.0
				J	-29.0	-0.1	0.3	0.0	0.0
			Min	I	-334.5	0.1	-0.3	0.0	0.0
				J	-333.5	-0.5	0.2	0.0	0.0
			INVSLEQP Max	I	-154.8	0.3	-0.2	0.0	0.0
				J	-153.7	-0.3	0.2	0.0	0.0
			Min	I	-169.3	0.3	-0.2	0.0	0.0
				J	-168.2	-0.3	0.2	0.0	0.0
			INVSLEF Max	I	-111.0	0.3	-0.2	0.0	0.0
				J	-109.9	-0.2	0.2	0.0	0.0
			Min	I	-267.9	0.2	-0.2	0.0	0.0
				J	-266.8	-0.3	0.2	0.0	0.0
1206	2	85	INVSLE Max	I	208.4	0.3	-0.1	0.0	0.0
				J	209.2	0.8	0.4	0.0	0.0
			Min	I	-522.4	-0.8	-0.4	0.0	0.0
				J	-520.9	-0.3	0.1	0.0	0.0
			INVSLE Min	I	310.2	-0.3	-0.2	0.0	0.0
				J	311.3	0.3	0.2	0.0	0.0
			Min	I	-249.2	-0.3	-0.2	0.0	0.0
				J	-248.1	0.3	0.2	0.0	0.0
			INVSLE Max	I	-69.7	-0.1	-0.2	0.0	0.0
				J	-68.6	0.5	0.3	0.0	0.0
			Min	I	-408.0	-0.5	-0.3	0.0	0.0
				J	-406.9	0.1	0.2	0.0	0.0
			INVSLEQP Max	I	-205.3	-0.3	-0.2	0.0	0.0
				J	-204.2	0.3	0.2	0.0	0.0
			Min	I	-221.0	-0.3	-0.2	0.0	0.0
				J	-219.9	0.3	0.2	0.0	0.0
			INVSLEF Max	I	-154.9	-0.2	-0.2	0.0	0.0
				J	-153.8	0.3	0.2	0.0	0.0
			Min	I	-327.9	-0.3	-0.2	0.0	0.0
				J	-326.8	0.2	0.2	0.0	0.0
1209	2	85	INVSLE Max	I	174.6	0.9	-0.1	0.0	0.0
				J	175.4	0.3	0.4	0.0	0.0
			Min	I	-479.3	-0.3	-0.4	0.0	0.0
				J	-477.8	-0.9	0.1	0.0	0.0
			INVSLE Min	I	124.9	0.3	-0.2	0.0	0.0
				J	126.0	-0.3	0.2	0.0	0.0
			Min	I	-122.6	0.3	-0.2	0.0	0.0
				J	-121.5	-0.3	0.2	0.0	0.0
			INVSLE Max	I	-78.6	0.5	-0.2	0.0	0.0
				J	-77.5	-0.0	0.3	0.0	0.0
			Min	I	-381.0	0.0	-0.3	0.0	0.0
				J	-380.0	-0.5	0.2	0.0	0.0
			INVSLEQP Max	I	-229.1	0.3	-0.2	0.0	0.0
				J	-228.0	-0.3	0.2	0.0	0.0
			Min	I	-241.1	0.3	-0.2	0.0	0.0
				J	-240.0	-0.3	0.2	0.0	0.0
			INVSLEF Max	I	-151.4	0.3	-0.2	0.0	0.0
				J	-150.3	-0.2	0.2	0.0	0.0
			Min	I	-311.6	0.2	-0.2	0.0	0.0
				J	-310.5	-0.3	0.2	0.0	0.0
1210	2	84	INVSLE Max	I	437.2	11.4	29.3	0.1	14.3
				J	437.2	11.1	30.1	0.1	14.8
			Min	I	-139.3	-21.7	-31.0	-0.1	-16.5
				J	-139.3	-21.7	-30.2	-0.1	-16.1
			INVSLE Min	I	96.8	6.1	15.8	0.1	7.9
				J	96.8	6.1	16.4	0.1	8.3
			Min	I	-4.1	-6.9	-17.2	-0.1	-8.7
				J	-4.1	-6.9	-16.6	-0.1	-8.3
			INVSLE Max	I	385.2	1.8	21.5	0.1	10.5
				J	385.2	1.8	22.1	0.1	10.9
			Min	I	59.5	-16.9	-22.9	-0.0	-12.3
				J	59.5	-16.9	-22.3	-0.0	-11.9
			INVSLEQP Max	I	328.0	-7.6	-1.0	0.0	-0.9
				J	328.0	-7.6	-0.4	0.0	-0.2
			Min	I	175.8	-7.9	-1.1	0.0	-1.4
				J	175.8	-7.9	-0.5	0.0	-0.7
			INVSLEF Max	I	307.1	-2.4	11.1	0.0	5.2
				J	307.1	-2.4	11.7	0.0	5.7
			Min	I	137.4	-12.6	-12.5	-0.0	-7.0
				J	137.4	-12.6	-11.9	-0.0	-6.7
1211	2	84	INVSLE Max	I	174.7	11.4	31.5	0.1	15.4
				J	174.7	11.1	32.3	0.1	15.3
			Min	I	-137.3	-21.7	-32.0	-0.1	-17.0
				J	-137.3	-21.7	-31.2	-0.1	-17.2
			INVSLE Min	I	23.1	6.1	15.9	0.1	7.9
				J	23.1	6.1	16.5	0.1	8.2
			Min	I	-16.6	-6.9	-17.0	-0.1	-8.6

Sovrapasso di ingresso - Ponte strallato - Relazione di calcolo

			J	-16.6	-6.9	-16.4	-0.1	-8.3	-3.0	
			INVSLE Max	I	145.5	1.8	23.2	0.1	11.3	1.4
				J	145.5	1.8	23.8	0.1	11.2	8.9
			Min	I	-93.5	-16.9	-23.6	-0.0	-12.7	-8.1
				J	-93.5	-16.9	-23.0	-0.0	-12.8	-0.4
			INVSLEQP Max	I	81.8	-7.6	-0.6	0.0	-0.7	-3.3
				J	81.8	-7.6	0.0	0.0	-0.4	4.5
			Min	I	-34.8	-7.9	-0.6	0.0	-1.2	-3.5
				J	-34.8	-7.9	0.0	0.0	-0.9	4.4
			INVSLEF Max	I	86.0	-2.4	12.3	0.0	5.8	-0.7
				J	86.0	-2.4	12.9	0.0	5.8	6.7
			Min	I	-34.0	-12.6	-12.8	-0.0	-7.2	-5.9
				J	-34.0	-12.6	-12.2	-0.0	-7.2	1.7
1219	2	85	INVSLE Max	I	-52.6	0.6	-0.2	0.0	0.0	0.0
				J	-51.8	0.1	0.3	0.0	0.0	0.0
			Min	I	-937.3	-0.1	-0.3	0.0	0.0	0.0
				J	-935.9	-0.6	0.2	-0.0	0.0	0.0
			INVSLE Min	I	2.6	0.2	-0.2	0.0	0.0	0.0
				J	3.5	-0.2	0.2	0.0	0.0	0.0
			Min	I	-216.9	0.2	-0.2	0.0	0.0	0.0
				J	-216.0	-0.2	0.2	-0.0	0.0	0.0
			INVSLE Max	I	-586.7	0.4	-0.2	0.0	0.0	0.0
				J	-585.9	-0.1	0.3	0.0	0.0	0.0
			Min	I	-777.0	0.1	-0.3	0.0	0.0	0.0
				J	-776.0	-0.4	0.2	0.0	0.0	0.0
			INVSLEQP Max	I	-710.4	0.2	-0.2	0.0	0.0	0.0
				J	-709.5	-0.2	0.2	0.0	0.0	0.0
			Min	I	-750.7	0.2	-0.2	0.0	0.0	0.0
				J	-749.8	-0.2	0.2	0.0	0.0	0.0
			INVSLEF Max	I	-611.0	0.3	-0.2	0.0	0.0	0.0
				J	-610.1	-0.2	0.2	0.0	0.0	0.0
			Min	I	-723.1	0.2	-0.2	0.0	0.0	0.0
				J	-722.2	-0.3	0.2	0.0	0.0	0.0
1221	2	85	INVSLE Max	I	200.6	0.1	-0.1	0.0	0.0	0.0
				J	201.4	0.6	0.3	0.0	0.0	0.0
			Min	I	-302.1	-0.6	-0.3	0.0	0.0	0.0
				J	-300.9	-0.1	0.1	0.0	0.0	0.0
			INVSLE Min	I	150.8	-0.2	-0.2	0.0	0.0	0.0
				J	151.7	0.2	0.2	0.0	0.0	0.0
			Min	I	-72.5	-0.2	-0.2	0.0	0.0	0.0
				J	-71.6	0.2	0.2	0.0	0.0	0.0
			INVSLE Max	I	70.7	-0.1	-0.2	0.0	0.0	0.0
				J	71.6	0.4	0.3	0.0	0.0	0.0
			Min	I	-228.6	-0.4	-0.3	0.0	0.0	0.0
				J	-227.7	0.1	0.2	0.0	0.0	0.0
			INVSLEQP Max	I	-28.4	-0.2	-0.2	0.0	0.0	0.0
				J	-27.5	0.2	0.2	0.0	0.0	0.0
			Min	I	-68.7	-0.2	-0.2	0.0	0.0	0.0
				J	-67.8	0.2	0.2	0.0	0.0	0.0
			INVSLEF Max	I	-1.7	-0.2	-0.2	0.0	0.0	0.0
				J	-0.8	0.3	0.2	0.0	0.0	0.0
			Min	I	-177.0	-0.3	-0.2	0.0	0.0	0.0
				J	-176.1	0.2	0.2	0.0	0.0	0.0
1661	2	5	INVSLE Max	I	-161.5	0.3	21.9	8.1	67.0	-0.3
				J	-161.3	0.3	26.0	8.1	53.0	4.8
			Min	I	-1355.8	-2.4	-2.1	-1.0	10.1	-1.1
				J	-1355.6	-2.4	2.9	-1.0	-20.2	-1.6
			INVSLE Min	I	-66.2	0.7	8.6	2.7	30.9	1.5
				J	-66.1	0.7	12.2	2.7	14.8	1.2
			Min	I	-540.0	-1.4	-2.1	-0.2	4.7	-2.5
				J	-539.9	-1.4	1.6	-0.2	-3.6	-0.5
			INVSLE Max	I	-245.7	0.3	15.3	5.7	49.0	-0.3
				J	-245.6	0.3	19.0	5.7	39.3	3.5
			Min	I	-993.6	-1.7	-2.6	-1.0	15.5	-0.9
				J	-993.4	-1.7	1.0	-1.0	-5.9	-1.3
			INVSLEQP Max	I	-270.6	-0.2	1.7	0.7	16.8	-0.4
				J	-270.5	-0.2	5.4	0.7	8.5	-0.0
			Min	I	-318.1	-0.2	1.6	0.7	16.5	-0.5
				J	-317.9	-0.2	5.3	0.7	8.0	-0.0
			INVSLEF Max	I	-314.1	0.1	9.5	3.5	37.7	-0.4
				J	-313.9	0.1	13.1	3.5	29.9	1.9
			Min	I	-754.0	-1.0	-0.6	-0.3	18.6	-0.6
				J	-753.8	-1.0	3.1	-0.3	3.8	-0.8
1662	2	5	INVSLE Max	I	444.0	3.8	4.5	0.4	9.3	0.6
				J	444.2	3.8	9.4	0.4	78.1	0.4
			Min	I	-307.3	-0.2	-33.0	-13.3	-20.2	-0.2
				J	-307.1	-0.2	-29.3	-13.3	-26.4	-9.0
			INVSLE Min	I	95.5	2.8	-3.8	-1.8	5.3	1.3
				J	95.7	2.8	-0.2	-1.8	38.8	-0.6
			Min	I	-120.9	-0.2	-19.1	-7.3	-4.5	-1.6

Sovrapasso di ingresso - Ponte strallato - Relazione di calcolo

			J	-120.7	-0.2	-15.4	-7.3	8.6	-5.9
			I	309.3	2.5	2.5	0.2	3.8	0.4
			J	309.5	2.5	6.2	0.2	43.8	0.2
			I	-127.5	-0.1	-20.7	-8.8	-13.9	-0.1
			J	-127.3	-0.1	-17.0	-8.8	-14.5	-5.9
			I	-27.6	1.8	-15.8	-6.0	1.4	-0.1
			J	-27.4	1.8	-12.1	-6.0	36.4	-4.3
			I	-61.4	1.7	-16.3	-6.2	1.2	-0.1
			J	-61.2	1.7	-12.6	-6.2	34.9	-4.4
			I	217.7	1.6	-0.9	-1.1	1.1	0.2
			J	217.8	1.6	2.8	-1.1	25.2	-0.7
			I	-47.7	0.3	-12.8	-5.6	-8.9	-0.1
			J	-47.5	0.3	-9.2	-5.6	-7.3	-3.8
1663	2	5	I	415.9	0.2	32.8	13.2	9.3	0.4
			J	416.0	0.2	36.5	13.2	3.8	9.3
			I	-268.5	-3.8	-4.4	-0.5	-20.4	-0.2
			J	-268.5	-3.8	0.6	-0.5	-86.8	-0.5
			I	88.4	-0.0	17.8	6.9	5.4	1.2
			J	88.5	-0.0	21.5	6.9	-11.4	4.8
			I	-98.8	-2.5	4.3	1.9	-4.9	-1.5
			J	-98.7	-2.5	8.0	1.9	-50.5	0.9
			I	288.8	0.1	20.6	8.7	3.8	0.3
			J	288.9	0.1	24.3	8.7	1.9	6.2
			I	-97.1	-2.5	-2.6	-0.3	-14.1	-0.2
			J	-97.0	-2.5	1.1	-0.3	-60.3	-0.4
			I	-19.3	-1.7	15.7	5.9	1.2	-0.1
			J	-19.2	-1.7	19.3	5.9	-40.3	4.0
			I	-53.3	-1.7	15.2	5.8	1.0	-0.2
			J	-53.2	-1.7	18.9	5.8	-41.1	3.8
			I	209.3	-0.3	12.7	5.6	1.0	0.1
			J	209.3	-0.3	16.4	5.6	-7.5	3.9
			I	-29.0	-1.6	0.9	1.0	-9.0	-0.1
			J	-28.9	-1.6	4.5	1.0	-39.0	0.6
1664	2	5	I	-151.8	2.3	2.4	1.1	66.3	-0.4
			J	-151.8	2.3	7.4	1.1	104.1	-0.0
			I	-1303.4	-0.4	-21.5	-8.0	9.5	-1.3
			J	-1303.4	-0.4	-17.8	-8.0	11.0	-6.6
			I	-52.8	1.5	1.0	0.4	30.8	1.3
			J	-52.8	1.5	4.6	0.4	38.0	0.5
			I	-510.1	-1.0	-6.7	-2.6	3.8	-2.3
			J	-510.1	-1.0	-3.1	-2.6	1.5	-2.9
			I	-237.2	1.6	3.0	1.1	48.4	-0.3
			J	-237.3	1.6	6.6	1.1	75.6	0.3
			I	-953.5	-0.4	-15.1	-5.7	15.0	-1.0
			J	-953.5	-0.4	-11.5	-5.7	9.5	-4.7
			I	-247.5	0.1	-1.2	-0.5	16.3	-0.5
			J	-247.5	0.1	2.5	-0.5	14.7	-0.8
			I	-296.0	0.1	-1.3	-0.6	16.0	-0.5
			J	-296.0	0.1	2.4	-0.6	14.6	-0.8
			I	-302.8	1.0	0.9	0.4	37.2	-0.4
			J	-302.8	1.0	4.5	0.4	52.6	-0.2
			I	-723.8	-0.1	-9.2	-3.5	18.2	-0.7
			J	-723.9	-0.1	-5.6	-3.5	16.5	-3.1

BEAM ELEMENT FORCES & MOMENTS MIN/MAX SUMMARY BY PROPERTY PRINTOUT Unit System : kN , m

* LENGTH : the length between two nodes

[SECTION NAME : tubo , SECTION ID : 5 , SECTION SHAPE : P]
[SECTION SIZE] D:0.4064 tw:0.016

** MAX

ELEM COM	LC	PT	AXIAL	SHEAR-y	SHEAR-z	TORSION	MOMENT-y	MOMENT-z	LENGTH
682 AXL	INVSLU	1 J	854.4	4.5	9.4	-0.2	70.6	0.4	4.84
682 SHY	INVSLU	1 I	854.0	4.5	-0.4	-0.2	-17.1	11.8	4.84
683 SHZ	INVSLU	1 J	836.2	0.0	41.7	15.5	-16.7	11.5	4.83
683 TOR	INVSLU	1 J	836.2	0.0	41.7	15.5	-16.7	11.5	4.83
677 MTY	INVSLU	1 I	-138.5	0.1	21.8	9.5	119.1	-0.5	4.85
682 MTZ	INVSLU	1 I	854.0	4.5	-0.4	-0.2	-17.1	11.8	4.84

** MIN

ELEM COM	LC	PT	AXIAL	SHEAR-y	SHEAR-z	TORSION	MOMENT-y	MOMENT-z	LENGTH
676 AXL	INVSLU	1 I	-1356.1	-2.4	-7.0	-1.0	12.8	-6.6	2.42
683 SHY	INVSLU	1 I	-15.3	-4.5	-9.5	0.2	-44.4	-10.0	4.83
682 SHZ	INVSLU	1 I	-26.2	0.0	-42.2	-15.7	-122.9	0.3	4.84
682 TOR	INVSLU	1 I	-26.2	0.0	-42.2	-15.7	-122.9	0.3	4.84
682 MTY	INVSLU	1 I	-26.2	0.0	-42.2	-15.7	-122.9	0.3	4.84

Sovrapasso di ingresso - Ponte strallato - Relazione di calcolo

682 MTZ INVSLU 1 J -26.0 0.0 -34.9 -15.7 -43.9 -10.2 4.84

[SECTION NAME : baggio , SECTION ID : 8 , SECTION SHAPE : SB]
[SECTION SIZE] H:0.8 B:0.8

** MAX

ELEM COM	LC	PT	AXIAL	SHEAR-y	SHEAR-z	TORSION	MOMENT-y	MOMENT-z	LENGTH
405 AXL	INVSLER	1 I	-108.6	94.6	232.9	0.0	0.0	0.0	0.30
404 SHY	INVSLV	1 I	-831.9	943.4	900.1	0.0	0.0	0.0	0.30
409 SHZ	INVSLV	1 I	-1103.0	0.9	4514.0	0.0	0.0	0.0	0.30
409 TOR	INVSLV	1 I	-2027.7	-0.9	-4692.9	0.0	0.0	0.0	0.30
409 MTY	INVSLV	1 J	-1107.7	0.9	4514.0	0.0	1407.9	0.3	0.30
404 MTZ	INVSLV	1 J	-836.6	943.4	900.1	0.0	226.3	1357.5	0.30

** MIN

ELEM COM	LC	PT	AXIAL	SHEAR-y	SHEAR-z	TORSION	MOMENT-y	MOMENT-z	LENGTH
404 AXL	INVSLU	1 J	-5290.1	-3589.9	-1288.2	0.0	-474.6	264.8	0.30
404 SHY	INVSLV	1 I	-2091.2	-4524.9	-754.2	0.0	0.0	0.0	0.30
409 SHZ	INVSLV	1 I	-2027.7	-0.9	-4692.9	0.0	0.0	0.0	0.30
409 TOR	INVSLV	1 I	-2027.7	-0.9	-4692.9	0.0	0.0	0.0	0.30
409 MTY	INVSLV	1 J	-2032.4	-0.9	-4692.9	0.0	-1354.2	-0.3	0.30
404 MTZ	INVSLV	1 J	-2095.9	-4524.9	-754.2	0.0	-270.0	-283.0	0.30

[SECTION NAME : A1s , SECTION ID : 40]

** MAX

ELEM COM	LC	PT	AXIAL	SHEAR-y	SHEAR-z	TORSION	MOMENT-y	MOMENT-z	LENGTH
107 AXL	INVSLV	1 J	2045.4	56.4	210.5	136.7	443.7	-1055.2	2.40
107 SHY	INVSLV	1 I	1916.1	112.6	210.5	136.7	823.6	-933.4	2.40
107 SHZ	INVSLU	1 I	707.2	-90.6	290.4	210.3	722.2	-1829.4	2.40
107 TOR	INVSLV	1 I	707.2	-90.6	290.4	210.3	722.2	-1829.4	2.40
107 MTY	INVSLV	1 I	1916.1	112.6	210.5	136.7	823.6	-933.4	2.40
107 MTZ	INVSLV	1 I	1916.1	112.6	210.5	136.7	823.6	-933.4	2.40

** MIN

ELEM COM	LC	PT	AXIAL	SHEAR-y	SHEAR-z	TORSION	MOMENT-y	MOMENT-z	LENGTH
107 AXL	INVSLV	1 I	-7256.7	-895.2	-310.9	-124.5	-933.4	-9091.2	2.40
107 SHY	INVSLV	1 J	-7127.4	-951.4	-310.9	-124.5	-312.4	-6951.7	2.40
107 SHZ	INVSLU	1 I	-6842.5	-753.2	-518.3	-6.5	-970.1	-8595.7	2.40
107 TOR	INVSLV	1 J	-7127.4	-951.4	-310.9	-124.5	-312.4	-6951.7	2.40
107 MTY	INVSLU	1 I	-6842.5	-753.2	-518.3	-6.5	-970.1	-8595.7	2.40
107 MTZ	INVSLV	1 I	-7256.7	-895.2	-310.9	-124.5	-933.4	-9091.2	2.40

[SECTION NAME : A2s , SECTION ID : 41]

** MAX

ELEM COM	LC	PT	AXIAL	SHEAR-y	SHEAR-z	TORSION	MOMENT-y	MOMENT-z	LENGTH
120 AXL	INVSLV	1 J	1223.1	12.3	352.5	39.9	619.5	-1064.6	0.60
120 SHY	INVSLV	1 I	1193.9	25.3	352.5	39.9	811.8	-1068.7	0.60
120 SHZ	INVSLU	1 I	-304.7	-143.5	512.9	-35.0	667.4	-1532.3	0.60
120 TOR	INVSLV	1 I	1193.9	25.3	352.5	39.9	811.8	-1068.7	0.60
120 MTY	INVSLV	1 I	1193.9	25.3	352.5	39.9	811.8	-1068.7	0.60
120 MTZ	INVSLV	1 J	1223.1	12.3	352.5	39.9	619.5	-1064.6	0.60

** MIN

ELEM COM	LC	PT	AXIAL	SHEAR-y	SHEAR-z	TORSION	MOMENT-y	MOMENT-z	LENGTH
120 AXL	INVSLV	1 I	-6274.6	-880.1	-234.2	-122.0	-638.7	-6942.4	0.60
120 SHY	INVSLV	1 J	-6245.4	-893.1	-234.2	-122.0	-517.4	-6425.6	0.60
120 SHZ	INVSLU	1 J	-5461.5	-800.8	-315.0	-207.0	-285.3	-6308.0	0.60
120 TOR	INVSLU	1 J	-5461.5	-800.8	-315.0	-207.0	-285.3	-6308.0	0.60
120 MTY	INVSLV	1 I	-6274.6	-880.1	-234.2	-122.0	-638.7	-6942.4	0.60
120 MTZ	INVSLV	1 I	-6274.6	-880.1	-234.2	-122.0	-638.7	-6942.4	0.60

[SECTION NAME : A3s , SECTION ID : 42]

** MAX

ELEM COM	LC	PT	AXIAL	SHEAR-y	SHEAR-z	TORSION	MOMENT-y	MOMENT-z	LENGTH
847 AXL	INVSLV	1 J	1308.5	-92.3	356.8	55.7	180.0	-893.8	1.80
847 SHY	INVSLV	1 I	1227.4	-57.3	356.8	55.7	581.9	-1064.6	1.80
847 SHZ	INVSLU	1 I	-259.5	-184.4	489.0	-19.5	339.2	-1441.4	1.80
847 TOR	INVSLV	1 J	1308.5	-92.3	356.8	55.7	180.0	-893.8	1.80
847 MTY	INVSLV	1 I	1227.4	-57.3	356.8	55.7	581.9	-1064.6	1.80
847 MTZ	INVSLV	1 J	1308.5	-92.3	356.8	55.7	180.0	-893.8	1.80

** MIN

ELEM COM	LC	PT	AXIAL	SHEAR-y	SHEAR-z	TORSION	MOMENT-y	MOMENT-z	LENGTH
847 AXL	INVSLV	1 I	-6239.1	-884.9	-264.8	-109.2	-542.3	-6426.5	1.80
847 SHY	INVSLV	1 J	-6158.0	-919.9	-264.8	-109.2	-306.0	-4835.6	1.80
847 SHZ	INVSLU	1 J	-5374.1	-897.6	-325.0	-193.5	-615.3	-4728.4	1.80
847 TOR	INVSLU	1 J	-5374.1	-897.6	-325.0	-193.5	-615.3	-4728.4	1.80
847 MTY	INVSLU	1 J	-5374.1	-897.6	-325.0	-193.5	-615.3	-4728.4	1.80

Sovrapasso di ingresso - Ponte strallato - Relazione di calcolo

847 MTZ INVSLV 1 I -6239.1 -884.9 -264.8 -109.2 -542.3 -6426.5 1.80

[SECTION NAME : A4s , SECTION ID : 43]

** MAX

ELEM COM	LC	PT	AXIAL	SHEAR-y	SHEAR-z	TORSION	MOMENT-y	MOMENT-z	LENGTH
124 AXL	INVSLV	1 J	536.3	-149.5	613.2	20.2	92.7	-747.8	0.60
124 SHY	INVSLV	1 I	511.6	-138.8	613.2	20.2	404.8	-856.9	0.60
124 SHZ	INVSLV	1 I	-1203.3	-257.4	744.0	124.5	92.2	-1126.9	0.60
124 TOR	INVSLV	1 I	-1203.3	-257.4	744.0	124.5	92.2	-1126.9	0.60
124 MTY	INVSLV	1 I	511.6	-138.8	613.2	20.2	404.8	-856.9	0.60
124 MTZ	INVSLV	1 J	536.3	-149.5	613.2	20.2	92.7	-747.8	0.60

** MIN

ELEM COM	LC	PT	AXIAL	SHEAR-y	SHEAR-z	TORSION	MOMENT-y	MOMENT-z	LENGTH
124 AXL	INVSLV	1 I	-5394.3	-874.0	-107.3	-122.9	-524.1	-4894.3	0.60
124 SHY	INVSLV	1 J	-4381.8	-908.7	-267.2	-123.9	-468.6	-4340.2	0.60
124 SHZ	INVSLV	1 I	-4406.1	-897.3	-268.3	-123.9	-296.0	-4836.0	0.60
124 TOR	INVSLV	1 J	-4381.8	-908.7	-267.2	-123.9	-468.6	-4340.2	0.60
124 MTY	INVSLV	1 I	-5394.3	-874.0	-107.3	-122.9	-524.1	-4894.3	0.60
124 MTZ	INVSLV	1 I	-5394.3	-874.0	-107.3	-122.9	-524.1	-4894.3	0.60

[SECTION NAME : A5s , SECTION ID : 44]

** MAX

ELEM COM	LC	PT	AXIAL	SHEAR-y	SHEAR-z	TORSION	MOMENT-y	MOMENT-z	LENGTH
846 AXL	INVSLV	1 J	943.1	-109.3	200.5	91.6	323.7	-487.9	1.80
846 SHY	INVSLV	1 I	875.5	-79.9	200.5	91.6	320.3	-701.9	1.80
846 SHZ	INVSLV	1 J	943.1	-109.3	200.5	91.6	323.7	-487.9	1.80
846 TOR	INVSLV	1 J	-770.4	-229.0	131.0	146.6	702.5	-465.6	1.80
846 MTY	INVSLV	1 J	-770.4	-229.0	131.0	146.6	702.5	-465.6	1.80
846 MTZ	INVSLV	1 J	-770.4	-229.0	131.0	146.6	702.5	-465.6	1.80

** MIN

ELEM COM	LC	PT	AXIAL	SHEAR-y	SHEAR-z	TORSION	MOMENT-y	MOMENT-z	LENGTH
846 AXL	INVSLV	1 I	-4661.9	-738.1	-325.3	-68.1	-365.7	-4355.8	1.80
846 SHY	INVSLV	1 J	-4594.3	-767.5	-325.3	-68.1	-144.3	-3042.3	1.80
846 SHZ	INVSLV	1 J	-3438.2	-766.1	-385.5	-2.5	-288.4	-2989.3	1.80
846 TOR	INVSLV	1 J	-4594.3	-767.5	-325.3	-68.1	-144.3	-3042.3	1.80
846 MTY	INVSLV	1 I	-4661.9	-738.1	-325.3	-68.1	-365.7	-4355.8	1.80
846 MTZ	INVSLV	1 I	-4661.9	-738.1	-325.3	-68.1	-365.7	-4355.8	1.80

[SECTION NAME : A6s , SECTION ID : 45]

** MAX

ELEM COM	LC	PT	AXIAL	SHEAR-y	SHEAR-z	TORSION	MOMENT-y	MOMENT-z	LENGTH
127 AXL	INVSLV	1 J	64.2	-170.7	713.5	33.4	67.7	-433.8	0.60
127 SHY	INVSLV	1 I	43.8	-161.8	713.5	33.4	361.5	-541.8	0.60
127 SHZ	INVSLV	1 J	-911.0	-240.2	933.9	-20.8	207.0	-411.3	0.60
127 TOR	INVSLV	1 J	64.2	-170.7	713.5	33.4	67.7	-433.8	0.60
127 MTY	INVSLV	1 I	-938.7	-227.6	931.4	-20.8	385.4	-575.4	0.60
127 MTZ	INVSLV	1 J	-911.0	-240.2	933.9	-20.8	207.0	-411.3	0.60

** MIN

ELEM COM	LC	PT	AXIAL	SHEAR-y	SHEAR-z	TORSION	MOMENT-y	MOMENT-z	LENGTH
127 AXL	INVSLV	1 I	-3689.8	-743.7	-0.7	-86.2	-196.2	-3002.1	0.60
127 SHY	INVSLV	1 J	-3061.4	-821.0	209.7	-170.0	-589.3	-2295.3	0.60
127 SHZ	INVSLV	1 J	-3669.4	-752.6	-0.7	-86.2	-330.5	-2561.0	0.60
127 TOR	INVSLV	1 J	-3061.4	-821.0	209.7	-170.0	-589.3	-2295.3	0.60
127 MTY	INVSLV	1 J	-3061.4	-821.0	209.7	-170.0	-589.3	-2295.3	0.60
127 MTZ	INVSLV	1 I	-3689.8	-743.7	-0.7	-86.2	-196.2	-3002.1	0.60

[SECTION NAME : A7s , SECTION ID : 46]

** MAX

ELEM COM	LC	PT	AXIAL	SHEAR-y	SHEAR-z	TORSION	MOMENT-y	MOMENT-z	LENGTH
845 AXL	INVSLV	1 J	333.1	-131.5	289.1	72.8	148.5	-274.9	1.20
845 SHY	INVSLV	1 I	295.2	-115.1	289.1	72.8	176.0	-432.9	1.20
845 SHZ	INVSLV	1 J	-287.2	-177.5	295.2	39.9	236.4	-194.7	1.20
845 TOR	INVSLV	1 J	333.1	-131.5	289.1	72.8	148.5	-274.9	1.20
845 MTY	INVSLV	1 I	-338.4	-154.0	290.3	39.9	291.2	-409.9	1.20
845 MTZ	INVSLV	1 J	-287.2	-177.5	295.2	39.9	236.4	-194.7	1.20

** MIN

ELEM COM	LC	PT	AXIAL	SHEAR-y	SHEAR-z	TORSION	MOMENT-y	MOMENT-z	LENGTH
845 AXL	INVSLV	1 I	-3117.6	-630.9	-165.5	-67.4	-190.8	-2559.9	1.20
845 SHY	INVSLV	1 J	-2468.2	-667.1	-11.6	-148.7	-598.5	-1509.8	1.20
845 SHZ	INVSLV	1 J	-3079.7	-647.4	-165.5	-67.4	-311.7	-1802.2	1.20
845 TOR	INVSLV	1 J	-2468.2	-667.1	-11.6	-148.7	-598.5	-1509.8	1.20
845 MTY	INVSLV	1 J	-2468.2	-667.1	-11.6	-148.7	-598.5	-1509.8	1.20

Sovrapasso di ingresso - Ponte strallato - Relazione di calcolo

845 MTZ INVSLV 1 I -3117.6 -630.9 -165.5 -67.4 -190.8 -2559.9 1.20

[SECTION NAME : A8s , SECTION ID : 47]

** MAX

ELEM COM	LC	PT	AXIAL	SHEAR-y	SHEAR-z	TORSION	MOMENT-y	MOMENT-z	LENGTH
844 AXL	INVSLV	1 J	441.2	-104.1	7.4	95.2	312.6	-220.0	0.60
844 SHY	INVSLV	1 I	175.6	-88.0	-56.3	72.7	300.2	-208.6	0.60
844 SHZ	INVSLV	1 I	423.7	-96.5	7.4	95.2	172.2	-284.8	0.60
844 TOR	INVSLV	1 J	441.2	-104.1	7.4	95.2	312.6	-220.0	0.60
844 MTY	INVSLV	1 J	199.2	-98.9	-53.8	72.7	416.6	-152.4	0.60
844 MTZ	INVSLV	1 J	199.2	-98.9	-53.8	72.7	416.6	-152.4	0.60

** MIN

ELEM COM	LC	PT	AXIAL	SHEAR-y	SHEAR-z	TORSION	MOMENT-y	MOMENT-z	LENGTH
844 AXL	INVSLV	1 I	-2682.0	-553.0	-318.7	-66.1	-191.5	-1808.8	0.60
844 SHY	INVSLV	1 J	-2118.0	-567.8	-420.2	-137.5	-185.7	-1184.7	0.60
844 SHZ	INVSLV	1 J	-2118.0	-567.8	-420.2	-137.5	-185.7	-1184.7	0.60
844 TOR	INVSLV	1 J	-2118.0	-567.8	-420.2	-137.5	-185.7	-1184.7	0.60
844 MTY	INVSLV	1 I	-2135.2	-559.6	-420.2	-137.5	-400.3	-1522.6	0.60
844 MTZ	INVSLV	1 I	-2682.0	-553.0	-318.7	-66.1	-191.5	-1808.8	0.60

[SECTION NAME : A9s , SECTION ID : 48]

** MAX

ELEM COM	LC	PT	AXIAL	SHEAR-y	SHEAR-z	TORSION	MOMENT-y	MOMENT-z	LENGTH
134 AXL	INVSLV	1 J	-5.5	-179.1	529.2	74.1	145.7	-122.9	0.60
134 SHY	INVSLV	1 I	-176.3	-140.9	448.0	19.9	206.8	-204.8	0.60
134 SHZ	INVSLV	1 I	-27.9	-169.5	529.3	74.1	369.7	-236.8	0.60
134 TOR	INVSLV	1 I	-27.9	-169.5	529.3	74.1	369.7	-236.8	0.60
134 MTY	INVSLV	1 I	-27.9	-169.5	529.3	74.1	369.7	-236.8	0.60
134 MTZ	INVSLV	1 J	-159.7	-148.1	448.0	19.9	65.3	-99.5	0.60

** MIN

ELEM COM	LC	PT	AXIAL	SHEAR-y	SHEAR-z	TORSION	MOMENT-y	MOMENT-z	LENGTH
134 AXL	INVSLV	1 I	-2172.6	-577.6	143.6	-23.0	-179.3	-1275.1	0.60
134 SHY	INVSLV	1 J	-2156.3	-585.4	141.2	-23.0	-392.8	-928.9	0.60
134 SHZ	INVSLV	1 J	-2116.5	-555.1	-47.9	-55.2	-204.2	-1233.0	0.60
134 TOR	INVSLV	1 J	-2116.5	-555.1	-47.9	-55.2	-204.2	-1233.0	0.60
134 MTY	INVSLV	1 J	-2156.3	-585.4	141.2	-23.0	-392.8	-928.9	0.60
134 MTZ	INVSLV	1 I	-2133.1	-547.9	-47.9	-55.2	-105.5	-1545.6	0.60

[SECTION NAME : A10s , SECTION ID : 49]

** MAX

ELEM COM	LC	PT	AXIAL	SHEAR-y	SHEAR-z	TORSION	MOMENT-y	MOMENT-z	LENGTH
843 AXL	INVSLV	1 J	419.9	-110.9	143.2	80.0	77.9	84.0	1.20
843 SHY	INVSLV	1 I	378.8	-93.2	140.8	80.0	213.1	-138.3	1.20
843 SHZ	INVSLV	1 J	419.9	-110.9	143.2	80.0	77.9	84.0	1.20
843 TOR	INVSLV	1 J	419.9	-110.9	143.2	80.0	77.9	84.0	1.20
843 MTY	INVSLV	1 I	378.8	-93.2	140.8	80.0	213.1	-138.3	1.20
843 MTZ	INVSLV	1 J	419.9	-110.9	143.2	80.0	77.9	84.0	1.20

** MIN

ELEM COM	LC	PT	AXIAL	SHEAR-y	SHEAR-z	TORSION	MOMENT-y	MOMENT-z	LENGTH
843 AXL	INVSLV	1 I	-1858.8	-469.1	-151.2	-18.9	-255.0	-957.2	1.20
843 SHY	INVSLV	1 J	-1828.9	-483.3	-156.0	-18.9	-132.8	-432.8	1.20
843 SHZ	INVSLV	1 J	-1828.9	-483.3	-156.0	-18.9	-132.8	-432.8	1.20
843 TOR	INVSLV	1 J	-1745.5	-474.9	-132.8	-52.7	-145.8	-730.5	1.20
843 MTY	INVSLV	1 I	-1858.8	-469.1	-151.2	-18.9	-255.0	-957.2	1.20
843 MTZ	INVSLV	1 I	-1775.9	-461.7	-132.8	-52.7	-118.4	-1241.3	1.20

[SECTION NAME : A11s , SECTION ID : 50]

** MAX

ELEM COM	LC	PT	AXIAL	SHEAR-y	SHEAR-z	TORSION	MOMENT-y	MOMENT-z	LENGTH
842 AXL	INVSLV	1 J	663.2	-54.5	-66.0	74.1	279.7	186.6	0.60
842 SHY	INVSLV	1 I	644.4	-45.8	-68.3	74.1	126.6	66.9	0.60
842 SHZ	INVSLV	1 J	408.0	-90.8	-61.0	56.5	230.1	103.5	0.60
842 TOR	INVSLV	1 I	644.4	-45.8	-68.3	74.1	126.6	66.9	0.60
842 MTY	INVSLV	1 J	25.4	-91.6	-78.9	24.0	293.7	137.0	0.60
842 MTZ	INVSLV	1 J	663.2	-54.5	-66.0	74.1	279.7	186.6	0.60

** MIN

ELEM COM	LC	PT	AXIAL	SHEAR-y	SHEAR-z	TORSION	MOMENT-y	MOMENT-z	LENGTH
842 AXL	INVSLV	1 I	-1554.8	-372.9	-479.2	-24.1	-41.4	-467.8	0.60
842 SHY	INVSLEQP	1 J	-740.9	-395.5	-217.9	23.2	246.0	-222.9	0.60
842 SHZ	INVSLV	1 J	-1541.2	-379.5	-479.2	-24.1	106.4	-320.2	0.60
842 TOR	INVSLV	1 J	-1432.8	-392.8	-311.9	-60.6	30.2	-547.5	0.60
842 MTY	INVSLV	1 I	-1446.7	-386.8	-311.9	-60.6	-70.1	-736.8	0.60

Sovrapasso di ingresso - Ponte strallato - Relazione di calcolo

842 MTZ INVSLV 1 I -1446.7 -386.8 -311.9 -60.6 -70.1 -736.8 0.60

[SECTION NAME : A12s , SECTION ID : 51]

** MAX

ELEM COM	LC	PT	AXIAL	SHEAR-y	SHEAR-z	TORSION	MOMENT-y	MOMENT-z	LENGTH
131 AXL	INVSLU	1 J	205.2	-37.1	721.5	81.7	-34.2	280.7	0.60
131 SHY	INVSLU	1 I	187.5	-29.5	721.5	81.7	301.1	252.0	0.60
131 SHZ	INVSLU	1 I	187.5	-29.5	721.5	81.7	301.1	252.0	0.60
131 TOR	INVSLV	1 J	-338.9	-148.6	633.7	99.3	-31.9	108.0	0.60
131 MTY	INVSLU	1 I	187.5	-29.5	721.5	81.7	301.1	252.0	0.60
131 MTZ	INVSLU	1 J	205.2	-37.1	721.5	81.7	-34.2	280.7	0.60

** MIN

ELEM COM	LC	PT	AXIAL	SHEAR-y	SHEAR-z	TORSION	MOMENT-y	MOMENT-z	LENGTH
131 AXL	INVSLU	1 I	-1142.4	-398.0	110.5	-74.2	24.7	-414.7	0.60
131 SHY	INVSLU	1 J	-1129.6	-404.2	108.1	-74.2	-147.3	-177.2	0.60
131 SHZ	INVSLU	1 J	-1129.6	-404.2	108.1	-74.2	-147.3	-177.2	0.60
131 TOR	INVSLU	1 J	-1129.6	-404.2	108.1	-74.2	-147.3	-177.2	0.60
131 MTY	INVSLV	1 J	-1014.8	-389.8	263.0	18.1	-173.8	-235.6	0.60
131 MTZ	INVSLV	1 I	-1027.8	-384.1	263.0	18.1	93.5	-462.0	0.60

[SECTION NAME : A13s , SECTION ID : 52]

** MAX

ELEM COM	LC	PT	AXIAL	SHEAR-y	SHEAR-z	TORSION	MOMENT-y	MOMENT-z	LENGTH
841 AXL	INVSLU	1 J	387.2	1.1	253.2	54.7	36.0	246.2	1.20
841 SHY	INVSLU	1 I	355.2	14.8	253.2	54.7	-0.2	254.4	1.20
841 SHZ	INVSLU	1 I	355.2	14.8	253.2	54.7	-0.2	254.4	1.20
841 TOR	INVSLV	1 J	-154.2	-76.0	205.0	72.1	-113.9	148.7	1.20
841 MTY	INVSLU	1 J	387.2	1.1	253.2	54.7	36.0	246.2	1.20
841 MTZ	INVSLU	1 I	355.2	14.8	253.2	54.7	-0.2	254.4	1.20

** MIN

ELEM COM	LC	PT	AXIAL	SHEAR-y	SHEAR-z	TORSION	MOMENT-y	MOMENT-z	LENGTH
841 AXL	INVSLU	1 I	-721.5	-230.6	-41.6	-83.1	-57.7	-235.1	1.20
841 SHY	INVSLV	1 J	-597.8	-252.7	80.0	11.1	-306.1	27.3	1.20
841 SHZ	INVSLU	1 J	-698.3	-241.9	-46.5	-83.1	-336.5	45.9	1.20
841 TOR	INVSLU	1 J	-698.3	-241.9	-46.5	-83.1	-336.5	45.9	1.20
841 MTY	INVSLU	1 J	-698.3	-241.9	-46.5	-83.1	-336.5	45.9	1.20
841 MTZ	INVSLV	1 I	-621.4	-242.4	80.0	11.1	-83.2	-264.4	1.20

[SECTION NAME : A14s , SECTION ID : 60]

** MAX

ELEM COM	LC	PT	AXIAL	SHEAR-y	SHEAR-z	TORSION	MOMENT-y	MOMENT-z	LENGTH
840 AXL	INVSLU	1 J	470.8	35.7	-114.6	7.1	120.9	218.9	0.60
840 SHY	INVSLV	1 I	109.7	73.5	-207.8	27.4	-60.4	68.4	0.60
840 SHZ	INVSLU	1 I	456.5	42.1	-112.2	7.1	50.6	231.0	0.60
840 TOR	INVSLV	1 J	120.3	68.8	-207.8	27.4	72.5	63.3	0.60
840 MTY	INVSLU	1 J	470.8	35.7	-114.6	7.1	120.9	218.9	0.60
840 MTZ	INVSLU	1 I	456.5	42.1	-112.2	7.1	50.6	231.0	0.60

** MIN

ELEM COM	LC	PT	AXIAL	SHEAR-y	SHEAR-z	TORSION	MOMENT-y	MOMENT-z	LENGTH
840 AXL	INVSLU	1 I	-153.4	10.3	-377.9	-95.7	-222.0	-51.4	0.60
840 SHY	INVSLV	1 J	-87.3	-48.1	-372.7	-24.5	16.1	-39.4	0.60
840 SHZ	INVSLEQP	1 I	259.2	32.7	-476.5	-68.3	-177.5	140.8	0.60
840 TOR	INVSLU	1 J	-143.0	5.2	-377.9	-95.7	2.4	-60.3	0.60
840 MTY	INVSLU	1 I	-153.4	10.3	-377.9	-95.7	-222.0	-51.4	0.60
840 MTZ	INVSLU	1 J	-143.0	5.2	-377.9	-95.7	2.4	-60.3	0.60

[SECTION NAME : A15s , SECTION ID : 61]

** MAX

ELEM COM	LC	PT	AXIAL	SHEAR-y	SHEAR-z	TORSION	MOMENT-y	MOMENT-z	LENGTH
140 AXL	INVSLV	1 J	4.9	16.5	8.5	3.5	0.9	1.1	0.70
140 SHY	INVSLV	1 I	-6.5	21.5	8.5	3.5	6.2	13.6	0.70
140 SHZ	INVSLV	1 I	-6.5	21.5	8.5	3.5	6.2	13.6	0.70
140 TOR	INVSLV	1 I	-6.5	21.5	8.5	3.5	6.2	13.6	0.70
140 MTY	INVSLV	1 I	-6.5	21.5	8.5	3.5	6.2	13.6	0.70
140 MTZ	INVSLV	1 I	-6.5	21.5	8.5	3.5	6.2	13.6	0.70

** MIN

ELEM COM	LC	PT	AXIAL	SHEAR-y	SHEAR-z	TORSION	MOMENT-y	MOMENT-z	LENGTH
140 AXL	INVSLV	1 I	-16.4	-11.6	-8.5	-3.5	-6.2	-10.1	0.70
140 SHY	INVSLV	1 J	-4.9	-16.5	-8.5	-3.5	-0.9	-1.1	0.70
140 SHZ	INVSLV	1 I	-16.4	-11.6	-8.5	-3.5	-6.2	-10.1	0.70
140 TOR	INVSLV	1 J	-4.9	-16.5	-8.5	-3.5	-0.9	-1.1	0.70
140 MTY	INVSLV	1 I	-16.4	-11.6	-8.5	-3.5	-6.2	-10.1	0.70

Sovrapasso di ingresso - Ponte strallato - Relazione di calcolo

140 MTZ INVSLV 1 I -16.4 -11.6 -8.5 -3.5 -6.2 -10.1 0.70

[SECTION NAME : A1d , SECTION ID : 62]

** MAX

ELEM COM	LC	PT	AXIAL	SHEAR-y	SHEAR-z	TORSION	MOMENT-y	MOMENT-z	LENGTH
103 AXL	INVSLV	1 J	2122.8	71.4	243.3	109.2	427.9	-1016.9	2.40
103 SHY	INVSLV	1 I	1993.5	127.5	243.3	109.2	872.6	-846.0	2.40
103 SHZ	INVSLU	1 J	927.5	-162.4	335.1	185.7	370.2	-1527.5	2.40
103 TOR	INVSLV	1 J	927.5	-162.4	335.1	185.7	370.2	-1527.5	2.40
103 MTY	INVSLV	1 I	1993.5	127.5	243.3	109.2	872.6	-846.0	2.40
103 MTZ	INVSLV	1 I	1993.5	127.5	243.3	109.2	872.6	-846.0	2.40

** MIN

ELEM COM	LC	PT	AXIAL	SHEAR-y	SHEAR-z	TORSION	MOMENT-y	MOMENT-z	LENGTH
103 AXL	INVSLV	1 I	-7074.8	-919.4	-276.3	-99.1	-891.4	-9235.2	2.40
103 SHY	INVSLV	1 J	-6945.5	-975.6	-276.3	-99.1	-367.6	-7024.2	2.40
103 SHZ	INVSLU	1 I	-6666.2	-784.1	-504.3	-10.5	-901.1	-8833.8	2.40
103 TOR	INVSLU	1 J	-6945.5	-975.6	-276.3	-99.1	-367.6	-7024.2	2.40
103 MTY	INVSLU	1 I	-6666.2	-784.1	-504.3	-10.5	-901.1	-8833.8	2.40
103 MTZ	INVSLV	1 I	-7074.8	-919.4	-276.3	-99.1	-891.4	-9235.2	2.40

[SECTION NAME : A2d , SECTION ID : 63]

** MAX

ELEM COM	LC	PT	AXIAL	SHEAR-y	SHEAR-z	TORSION	MOMENT-y	MOMENT-z	LENGTH
122 AXL	INVSLV	1 J	1447.7	17.4	310.4	97.0	559.5	-1098.3	0.60
122 SHY	INVSLV	1 I	1418.5	30.4	310.4	97.0	728.0	-1101.3	0.60
122 SHZ	INVSLU	1 I	-240.7	-161.2	522.8	22.9	680.0	-1580.5	0.60
122 TOR	INVSLU	1 I	1418.5	30.4	310.4	97.0	728.0	-1101.3	0.60
122 MTY	INVSLV	1 I	1418.5	30.4	310.4	97.0	728.0	-1101.3	0.60
122 MTZ	INVSLV	1 J	1447.7	17.4	310.4	97.0	559.5	-1098.3	0.60

** MIN

ELEM COM	LC	PT	AXIAL	SHEAR-y	SHEAR-z	TORSION	MOMENT-y	MOMENT-z	LENGTH
122 AXL	INVSLV	1 I	-6294.9	-893.6	-276.7	-104.9	-707.8	-6983.9	0.60
122 SHY	INVSLV	1 J	-6265.7	-906.6	-276.7	-104.9	-559.5	-6460.9	0.60
122 SHZ	INVSLU	1 I	-5436.1	-800.7	-353.9	-206.1	-512.3	-6783.6	0.60
122 TOR	INVSLU	1 J	-5407.3	-814.4	-353.9	-206.1	-304.3	-6327.2	0.60
122 MTY	INVSLV	1 I	-6294.9	-893.6	-276.7	-104.9	-707.8	-6983.9	0.60
122 MTZ	INVSLV	1 I	-6294.9	-893.6	-276.7	-104.9	-707.8	-6983.9	0.60

[SECTION NAME : Pila , SECTION ID : 67]

** MAX

ELEM COM	LC	PT	AXIAL	SHEAR-y	SHEAR-z	TORSION	MOMENT-y	MOMENT-z	LENGTH
4 AXL	INVSLV	1 I	-1153.5	1416.9	391.0	1407.5	2321.1	1955.8	3.92
4 SHY	INVSLV	1 I	-1153.5	1416.9	391.0	1407.5	2321.1	1955.8	3.92
3 SHZ	INVSLV	1 I	-1175.8	511.6	503.0	2557.9	2444.3	4504.6	5.42
3 TOR	INVSLV	1 I	-1175.8	511.6	503.0	2557.9	2444.3	4504.6	5.42
3 MTY	INVSLV	1 J	-1947.1	511.6	503.0	2557.9	7478.6	13056.2	5.42
3 MTZ	INVSLV	1 J	-1947.1	511.6	503.0	2557.9	7478.6	13056.2	5.42

** MIN

ELEM COM	LC	PT	AXIAL	SHEAR-y	SHEAR-z	TORSION	MOMENT-y	MOMENT-z	LENGTH
3 AXL	INVSLU	1 J	-6018.6	-1024.1	-425.5	480.8	1660.7	162.9	5.42
3 SHY	INVSLV	1 I	-2323.2	-1602.8	-947.1	-567.1	77.2	-2257.0	5.42
3 SHZ	INVSLV	1 I	-2323.2	-1602.8	-947.1	-567.1	77.2	-2257.0	5.42
4 TOR	INVSLV	1 I	-2317.5	-344.0	-826.8	-1919.5	161.3	-4400.2	3.92
3 MTY	INVSLV	1 J	-3094.5	-1602.8	-947.1	-567.1	-2550.3	-4894.1	5.42
4 MTZ	INVSLU	1 J	-5712.8	236.2	-433.1	-1358.6	1470.5	-10032.0	3.92

[SECTION NAME : A3d , SECTION ID : 68]

** MAX

ELEM COM	LC	PT	AXIAL	SHEAR-y	SHEAR-z	TORSION	MOMENT-y	MOMENT-z	LENGTH
863 AXL	INVSLV	1 J	1532.9	-80.7	340.3	81.3	202.5	-915.0	1.80
863 SHY	INVSLV	1 I	1451.8	-45.7	340.3	81.3	593.4	-1098.3	1.80
863 SHZ	INVSLU	1 I	-194.5	-198.2	528.7	5.6	407.4	-1477.3	1.80
863 TOR	INVSLV	1 J	1532.9	-80.7	340.3	81.3	202.5	-915.0	1.80
863 MTY	INVSLV	1 I	1451.8	-45.7	340.3	81.3	593.4	-1098.3	1.80
863 MTZ	INVSLV	1 J	1532.9	-80.7	340.3	81.3	202.5	-915.0	1.80

** MIN

ELEM COM	LC	PT	AXIAL	SHEAR-y	SHEAR-z	TORSION	MOMENT-y	MOMENT-z	LENGTH
863 AXL	INVSLV	1 I	-6258.6	-901.2	-281.0	-116.9	-529.2	-6460.6	1.80
863 SHY	INVSLV	1 J	-6177.5	-936.1	-281.0	-116.9	-245.2	-4873.9	1.80
863 SHZ	INVSLU	1 I	-5399.5	-872.2	-328.1	-217.4	-268.3	-6325.7	1.80
863 TOR	INVSLU	1 J	-5319.3	-909.3	-328.0	-217.4	-623.1	-4863.7	1.80
863 MTY	INVSLU	1 J	-5319.3	-909.3	-328.0	-217.4	-623.1	-4863.7	1.80

Sovrapasso di ingresso - Ponte strallato - Relazione di calcolo

863 MTZ INVSLV 1 I -6258.6 -901.2 -281.0 -116.9 -529.2 -6460.6 1.80

[SECTION NAME : A4d , SECTION ID : 69]

** MAX

ELEM COM	LC	PT	AXIAL	SHEAR-y	SHEAR-z	TORSION	MOMENT-y	MOMENT-z	LENGTH	
126 AXL	INVSLV	1	J	563.4	-137.7	64.5	110.1	471.7	-741.2	0.60
126 SHY	INVSLV	1	I	538.8	-127.0	64.5	110.1	450.1	-829.9	0.60
126 SHZ	INVSLU	1	I	-1027.5	-230.3	84.3	219.7	120.1	-1100.1	0.60
126 TOR	INVSLV	1	J	-994.3	-245.5	83.8	219.7	410.8	-952.1	0.60
126 MTY	INVSLV	1	J	563.4	-137.7	64.5	110.1	471.7	-741.2	0.60
126 MTZ	INVSLV	1	J	563.4	-137.7	64.5	110.1	471.7	-741.2	0.60

** MIN

ELEM COM	LC	PT	AXIAL	SHEAR-y	SHEAR-z	TORSION	MOMENT-y	MOMENT-z	LENGTH	
126 AXL	INVSLV	1	I	-5193.7	-904.7	-667.2	-15.2	-487.0	-4967.1	0.60
126 SHY	INVSLV	1	J	-4243.3	-949.0	-825.1	41.7	-120.6	-4236.5	0.60
126 SHZ	INVSLU	1	I	-4267.6	-937.6	-825.6	41.7	-290.5	-4798.3	0.60
126 TOR	INVSLV	1	J	-5169.1	-915.4	-667.2	-15.2	-146.7	-4430.0	0.60
126 MTY	INVSLV	1	I	-5193.7	-904.7	-667.2	-15.2	-487.0	-4967.1	0.60
126 MTZ	INVSLV	1	I	-5193.7	-904.7	-667.2	-15.2	-487.0	-4967.1	0.60

[SECTION NAME : A5d , SECTION ID : 70]

** MAX

ELEM COM	LC	PT	AXIAL	SHEAR-y	SHEAR-z	TORSION	MOMENT-y	MOMENT-z	LENGTH	
862 AXL	INVSLV	1	J	945.7	-92.9	273.2	60.2	202.1	-540.3	1.80
862 SHY	INVSLV	1	I	878.1	-63.5	273.2	60.2	330.2	-703.0	1.80
862 SHZ	INVSLV	1	I	878.1	-63.5	273.2	60.2	330.2	-703.0	1.80
862 TOR	INVSLU	1	J	-563.2	-202.2	240.2	165.1	485.7	-593.3	1.80
862 MTY	INVSLU	1	J	-563.2	-202.2	240.2	165.1	485.7	-593.3	1.80
862 MTZ	INVSLV	1	J	945.7	-92.9	273.2	60.2	202.1	-540.3	1.80

** MIN

ELEM COM	LC	PT	AXIAL	SHEAR-y	SHEAR-z	TORSION	MOMENT-y	MOMENT-z	LENGTH	
862 AXL	INVSLV	1	I	-4488.9	-757.0	-251.3	-97.0	-363.7	-4392.9	1.80
862 SHY	INVSLU	1	J	-3331.7	-791.2	-280.1	-50.0	-504.7	-2783.7	1.80
862 SHZ	INVSLU	1	J	-3331.7	-791.2	-280.1	-50.0	-504.7	-2783.7	1.80
862 TOR	INVSLV	1	J	-4421.3	-786.4	-251.3	-97.0	-275.2	-3023.6	1.80
862 MTY	INVSLU	1	J	-3331.7	-791.2	-280.1	-50.0	-504.7	-2783.7	1.80
862 MTZ	INVSLV	1	I	-4488.9	-757.0	-251.3	-97.0	-363.7	-4392.9	1.80

[SECTION NAME : A6d , SECTION ID : 71]

** MAX

ELEM COM	LC	PT	AXIAL	SHEAR-y	SHEAR-z	TORSION	MOMENT-y	MOMENT-z	LENGTH	
129 AXL	INVSLV	1	J	146.1	-166.6	58.8	53.8	356.4	-457.9	0.60
129 SHY	INVSLV	1	I	125.7	-157.7	58.8	53.8	257.9	-592.1	0.60
129 SHZ	INVSLV	1	I	125.7	-157.7	58.8	53.8	257.9	-592.1	0.60
129 TOR	INVSLV	1	J	146.1	-166.6	58.8	53.8	356.4	-457.9	0.60
129 MTY	INVSLU	1	J	-788.3	-255.0	-110.8	45.6	632.8	-464.9	0.60
129 MTZ	INVSLV	1	J	146.1	-166.6	58.8	53.8	356.4	-457.9	0.60

** MIN

ELEM COM	LC	PT	AXIAL	SHEAR-y	SHEAR-z	TORSION	MOMENT-y	MOMENT-z	LENGTH	
129 AXL	INVSLV	1	I	-3678.1	-757.5	-674.1	-42.7	-301.3	-3028.2	0.60
129 SHY	INVSLU	1	J	-3003.7	-844.9	-826.7	-148.6	-166.3	-2479.6	0.60
129 SHZ	INVSLU	1	I	-3023.9	-835.5	-826.8	-148.6	-256.1	-2929.9	0.60
129 TOR	INVSLU	1	J	-3003.7	-844.9	-826.7	-148.6	-166.3	-2479.6	0.60
129 MTY	INVSLV	1	I	-3678.1	-757.5	-674.1	-42.7	-301.3	-3028.2	0.60
129 MTZ	INVSLV	1	I	-3678.1	-757.5	-674.1	-42.7	-301.3	-3028.2	0.60

[SECTION NAME : A7d , SECTION ID : 72]

** MAX

ELEM COM	LC	PT	AXIAL	SHEAR-y	SHEAR-z	TORSION	MOMENT-y	MOMENT-z	LENGTH	
861 AXL	INVSLV	1	J	398.0	-121.7	212.8	29.3	302.0	-261.5	1.20
861 SHY	INVSLV	1	I	360.2	-105.2	212.8	29.3	226.5	-456.9	1.20
861 SHZ	INVSLV	1	J	398.0	-121.7	212.8	29.3	302.0	-261.5	1.20
861 TOR	INVSLV	1	J	398.0	-121.7	212.8	29.3	302.0	-261.5	1.20
861 MTY	INVSLU	1	J	-239.3	-184.8	98.0	-20.1	511.1	-192.4	1.20
861 MTZ	INVSLU	1	J	-239.3	-184.8	98.0	-20.1	511.1	-192.4	1.20

** MIN

ELEM COM	LC	PT	AXIAL	SHEAR-y	SHEAR-z	TORSION	MOMENT-y	MOMENT-z	LENGTH	
861 AXL	INVSLV	1	I	-3137.7	-635.9	-246.6	-81.0	-132.8	-2606.4	1.20
861 SHY	INVSLU	1	J	-2487.8	-671.8	-166.4	-168.8	-287.3	-1718.8	1.20
861 SHZ	INVSLV	1	J	-3099.9	-652.4	-246.6	-81.0	-167.7	-1892.0	1.20
861 TOR	INVSLU	1	J	-2487.8	-671.8	-166.4	-168.8	-287.3	-1718.8	1.20
861 MTY	INVSLU	1	J	-2487.8	-671.8	-166.4	-168.8	-287.3	-1718.8	1.20

Sovrapasso di ingresso - Ponte strallato - Relazione di calcolo

861 MTZ INVSLV 1 I -3137.7 -635.9 -246.6 -81.0 -132.8 -2606.4 1.20

[SECTION NAME : A8d , SECTION ID : 73]

** MAX

ELEM COM	LC	PT	AXIAL	SHEAR-y	SHEAR-z	TORSION	MOMENT-y	MOMENT-z	LENGTH
860 AXL	INVSLV	1 J	496.9	-93.2	351.4	27.0	100.5	-200.4	0.60
860 SHY	INVSLV	1 I	176.4	-83.4	544.1	-33.5	326.7	-211.0	0.60
860 SHZ	INVSLV	1 J	200.0	-94.3	544.6	-33.5	59.1	-139.9	0.60
860 TOR	INVSLV	1 I	479.4	-85.6	351.4	27.0	183.4	-272.6	0.60
860 MTY	INVSLV	1 I	176.4	-83.4	544.1	-33.5	326.7	-211.0	0.60
860 MTZ	INVSLV	1 J	200.0	-94.3	544.6	-33.5	59.1	-139.9	0.60

** MIN

ELEM COM	LC	PT	AXIAL	SHEAR-y	SHEAR-z	TORSION	MOMENT-y	MOMENT-z	LENGTH
860 AXL	INVSLV	1 I	-2729.6	-549.4	41.7	-105.6	-182.0	-1896.1	0.60
860 SHY	INVSLV	1 J	-2170.9	-563.3	153.4	-195.7	-506.7	-1402.8	0.60
860 SHZ	INVSLV	1 I	-2729.6	-549.4	41.7	-105.6	-182.0	-1896.1	0.60
860 TOR	INVSLV	1 J	-2170.9	-563.3	153.4	-195.7	-506.7	-1402.8	0.60
860 MTY	INVSLV	1 J	-2170.9	-563.3	153.4	-195.7	-506.7	-1402.8	0.60
860 MTZ	INVSLV	1 I	-2729.6	-549.4	41.7	-105.6	-182.0	-1896.1	0.60

[SECTION NAME : A9d , SECTION ID : 74]

** MAX

ELEM COM	LC	PT	AXIAL	SHEAR-y	SHEAR-z	TORSION	MOMENT-y	MOMENT-z	LENGTH
138 AXL	INVSLV	1 J	50.1	-104.0	-185.5	100.7	393.0	-11.3	0.60
138 SHY	INVSLV	1 I	27.8	-94.3	-186.0	100.7	148.6	-97.2	0.60
138 SHZ	INVSLV	1 I	-200.5	-133.7	26.4	53.9	58.0	-239.8	0.60
138 TOR	INVSLV	1 I	27.8	-94.3	-186.0	100.7	148.6	-97.2	0.60
138 MTY	INVSLV	1 J	50.1	-104.0	-185.5	100.7	393.0	-11.3	0.60
138 MTZ	INVSLV	1 J	50.1	-104.0	-185.5	100.7	393.0	-11.3	0.60

** MIN

ELEM COM	LC	PT	AXIAL	SHEAR-y	SHEAR-z	TORSION	MOMENT-y	MOMENT-z	LENGTH
138 AXL	INVSLV	1 I	-2043.3	-588.0	-589.0	-20.9	-413.2	-1444.6	0.60
138 SHY	INVSLV	1 J	-2027.0	-595.7	-589.5	-20.9	-168.7	-1106.1	0.60
138 SHZ	INVSLV	1 J	-2027.0	-595.7	-589.5	-20.9	-168.7	-1106.1	0.60
138 TOR	INVSLV	1 J	-1987.0	-568.5	-464.3	-55.3	-104.1	-1234.4	0.60
138 MTY	INVSLV	1 I	-2043.3	-588.0	-589.0	-20.9	-413.2	-1444.6	0.60
138 MTZ	INVSLV	1 I	-2003.5	-561.3	-464.3	-55.3	-252.2	-1567.1	0.60

[SECTION NAME : A10d , SECTION ID : 75]

** MAX

ELEM COM	LC	PT	AXIAL	SHEAR-y	SHEAR-z	TORSION	MOMENT-y	MOMENT-z	LENGTH
859 AXL	INVSLV	1 J	452.1	-23.7	102.0	96.1	185.4	-7.4	1.20
859 SHY	INVSLV	1 I	411.1	-5.9	101.0	96.1	262.8	-38.6	1.20
859 SHZ	INVSLV	1 J	-76.1	-115.7	109.0	52.4	141.2	-32.4	1.20
859 TOR	INVSLV	1 J	452.1	-23.7	102.0	96.1	185.4	-7.4	1.20
859 MTY	INVSLV	1 I	411.1	-5.9	101.0	96.1	262.8	-38.6	1.20
859 MTZ	INVSLV	1 J	452.1	-23.7	102.0	96.1	185.4	-7.4	1.20

** MIN

ELEM COM	LC	PT	AXIAL	SHEAR-y	SHEAR-z	TORSION	MOMENT-y	MOMENT-z	LENGTH
859 AXL	INVSLV	1 I	-1749.0	-472.6	-198.8	-33.3	-230.2	-1124.7	1.20
859 SHY	INVSLV	1 J	-1719.1	-486.8	-199.7	-33.3	-40.9	-559.3	1.20
859 SHZ	INVSLV	1 J	-1719.1	-486.8	-199.7	-33.3	-40.9	-559.3	1.20
859 TOR	INVSLV	1 J	-1642.2	-479.2	-134.6	-63.5	-148.8	-681.4	1.20
859 MTY	INVSLV	1 I	-1749.0	-472.6	-198.8	-33.3	-230.2	-1124.7	1.20
859 MTZ	INVSLV	1 I	-1672.6	-466.0	-134.6	-63.5	-127.6	-1244.4	1.20

[SECTION NAME : A11d , SECTION ID : 76]

** MAX

ELEM COM	LC	PT	AXIAL	SHEAR-y	SHEAR-z	TORSION	MOMENT-y	MOMENT-z	LENGTH
858 AXL	INVSLV	1 J	677.3	38.6	455.7	99.1	6.5	-55.7	0.60
858 SHY	INVSLV	1 I	658.5	46.7	455.7	99.1	110.1	-30.2	0.60
858 SHZ	INVSLV	1 J	677.3	38.6	455.7	99.1	6.5	-55.7	0.60
858 TOR	INVSLV	1 J	677.3	38.6	455.7	99.1	6.5	-55.7	0.60
858 MTY	INVSLV	1 I	658.5	46.7	455.7	99.1	110.1	-30.2	0.60
858 MTZ	INVSLV	1 J	-6.9	-84.2	295.6	57.8	-16.9	-3.5	0.60

** MIN

ELEM COM	LC	PT	AXIAL	SHEAR-y	SHEAR-z	TORSION	MOMENT-y	MOMENT-z	LENGTH
858 AXL	INVSLV	1 I	-1463.7	-370.6	8.1	-27.5	-101.1	-586.4	0.60
858 SHY	INVSLV	1 J	-1355.5	-389.7	44.8	-63.5	-277.8	-464.3	0.60
858 SHZ	INVSLV	1 J	-769.6	-213.3	7.6	43.8	-138.9	-302.2	0.60
858 TOR	INVSLV	1 J	-1355.5	-389.7	44.8	-63.5	-277.8	-464.3	0.60
858 MTY	INVSLV	1 J	-1355.5	-389.7	44.8	-63.5	-277.8	-464.3	0.60

Sovrapasso di ingresso - Ponte strallato - Relazione di calcolo

858 MTZ INVSLV 1 I -1369.4 -383.7 44.8 -63.5 -159.4 -693.3 0.60

[SECTION NAME : A12d , SECTION ID : 77]

** MAX

ELEM COM	LC	PT	AXIAL	SHEAR-y	SHEAR-z	TORSION	MOMENT-y	MOMENT-z	LENGTH
136 AXL	INVSLU	1 J	187.8	-58.2	-92.9	-66.7	157.3	32.1	0.60
136 SHY	INVSLU	1 I	170.2	-50.5	-93.4	-66.7	-32.5	-186.0	0.60
136 SHZ	INVSLU	1 J	187.8	-58.2	-92.9	-66.7	157.3	32.1	0.60
136 TOR	INVSLV	1 J	-330.5	-153.2	-253.0	-34.0	180.2	126.1	0.60
136 MTY	INVSLV	1 J	-330.5	-153.2	-253.0	-34.0	180.2	126.1	0.60
136 MTZ	INVSLV	1 J	-330.5	-153.2	-253.0	-34.0	180.2	126.1	0.60

** MIN

ELEM COM	LC	PT	AXIAL	SHEAR-y	SHEAR-z	TORSION	MOMENT-y	MOMENT-z	LENGTH
136 AXL	INVSLU	1 I	-1131.6	-403.0	-713.7	-119.4	-288.0	-332.8	0.60
136 SHY	INVSLEQP	1 J	-728.7	-418.3	-581.3	-157.5	142.3	-280.5	0.60
136 SHZ	INVSLU	1 I	-1131.6	-403.0	-713.7	-119.4	-288.0	-332.8	0.60
136 TOR	INVSLEQP	1 I	-741.8	-412.7	-581.3	-157.5	-203.5	-525.3	0.60
136 MTY	INVSLU	1 I	-1131.6	-403.0	-713.7	-119.4	-288.0	-332.8	0.60
136 MTZ	INVSLEQP	1 I	-741.8	-412.7	-581.3	-157.5	-203.5	-525.3	0.60

[SECTION NAME : A13d , SECTION ID : 78]

** MAX

ELEM COM	LC	PT	AXIAL	SHEAR-y	SHEAR-z	TORSION	MOMENT-y	MOMENT-z	LENGTH
857 AXL	INVSLU	1 J	358.8	-16.6	55.7	-53.2	339.2	247.3	1.20
857 SHY	INVSLU	1 I	326.9	-2.7	54.7	-53.2	71.6	-20.1	1.20
857 SHZ	INVSLU	1 J	358.8	-16.6	55.7	-53.2	339.2	247.3	1.20
857 TOR	INVSLV	1 I	-173.7	-62.5	-75.1	-34.2	97.4	75.2	1.20
857 MTY	INVSLU	1 J	358.8	-16.6	55.7	-53.2	339.2	247.3	1.20
857 MTZ	INVSLU	1 J	358.8	-16.6	55.7	-53.2	339.2	247.3	1.20

** MIN

ELEM COM	LC	PT	AXIAL	SHEAR-y	SHEAR-z	TORSION	MOMENT-y	MOMENT-z	LENGTH
857 AXL	INVSLU	1 I	-736.8	-223.5	-244.0	-101.7	-13.3	-304.6	1.20
857 SHY	INVSLEQP	1 J	-366.1	-265.5	-178.1	-138.0	273.9	-20.3	1.20
857 SHZ	INVSLU	1 I	-736.8	-223.5	-244.0	-101.7	-13.3	-304.6	1.20
857 TOR	INVSLEQP	1 J	-366.1	-265.5	-178.1	-138.0	273.9	-20.3	1.20
857 MTY	INVSLU	1 J	-713.6	-234.8	-244.0	-101.7	-64.3	-291.1	1.20
857 MTZ	INVSLEQP	1 I	-389.7	-255.2	-178.1	-138.0	65.5	-327.9	1.20

[SECTION NAME : A14d , SECTION ID : 79]

** MAX

ELEM COM	LC	PT	AXIAL	SHEAR-y	SHEAR-z	TORSION	MOMENT-y	MOMENT-z	LENGTH
856 AXL	INVSLU	1 J	438.2	39.3	393.4	-9.2	-2.6	131.4	0.60
856 SHY	INVSLV	1 I	104.4	94.0	383.5	1.0	207.9	138.4	0.60
856 SHZ	INVSLEQP	1 J	209.7	30.0	499.7	-77.4	-135.2	-129.7	0.60
856 TOR	INVSLV	1 J	115.0	89.4	383.5	1.0	-13.4	93.3	0.60
856 MTY	INVSLU	1 I	423.8	44.4	393.4	-9.2	230.9	155.3	0.60
856 MTZ	INVSLU	1 I	423.8	44.4	393.4	-9.2	230.9	155.3	0.60

** MIN

ELEM COM	LC	PT	AXIAL	SHEAR-y	SHEAR-z	TORSION	MOMENT-y	MOMENT-z	LENGTH
856 AXL	INVSLU	1 I	-198.8	4.2	120.7	-81.9	-77.7	-302.8	0.60
856 SHY	INVSLV	1 J	-133.1	-37.6	218.1	-37.2	-70.7	-86.0	0.60
856 SHZ	INVSLU	1 I	-198.8	4.2	120.7	-81.9	-77.7	-302.8	0.60
856 TOR	INVSLU	1 J	-188.4	-2.1	121.2	-81.9	-152.4	-304.9	0.60
856 MTY	INVSLU	1 J	-188.4	-2.1	121.2	-81.9	-152.4	-304.9	0.60
856 MTZ	INVSLU	1 J	-188.4	-2.1	121.2	-81.9	-152.4	-304.9	0.60

[SECTION NAME : A15d , SECTION ID : 80]

** MAX

ELEM COM	LC	PT	AXIAL	SHEAR-y	SHEAR-z	TORSION	MOMENT-y	MOMENT-z	LENGTH
142 AXL	INVSLV	1 J	4.9	16.6	8.4	3.6	0.9	1.0	0.70
142 SHY	INVSLV	1 I	-6.6	21.5	8.4	3.6	6.0	13.6	0.70
142 SHZ	INVSLV	1 J	4.9	16.6	8.4	3.6	0.9	1.0	0.70
142 TOR	INVSLV	1 I	-6.6	21.5	8.4	3.6	6.0	13.6	0.70
142 MTY	INVSLV	1 I	-6.6	21.5	8.4	3.6	6.0	13.6	0.70
142 MTZ	INVSLV	1 I	-6.6	21.5	8.4	3.6	6.0	13.6	0.70

** MIN

ELEM COM	LC	PT	AXIAL	SHEAR-y	SHEAR-z	TORSION	MOMENT-y	MOMENT-z	LENGTH
142 AXL	INVSLV	1 I	-16.3	-11.6	-8.4	-3.6	-6.0	-10.1	0.70
142 SHY	INVSLV	1 J	-4.9	-16.6	-8.4	-3.6	-0.9	-1.0	0.70
142 SHZ	INVSLV	1 J	-4.9	-16.6	-8.4	-3.6	-0.9	-1.0	0.70
142 TOR	INVSLV	1 J	-4.9	-16.6	-8.4	-3.6	-0.9	-1.0	0.70
142 MTY	INVSLV	1 I	-16.3	-11.6	-8.4	-3.6	-6.0	-10.1	0.70

Sovrappasso di ingresso - Ponte strallato - Relazione di calcolo

142 MTZ INVSLV 1 I -16.3 -11.6 -8.4 -3.6 -6.0 -10.1 0.70

[SECTION NAME : tubo219.1x12 , SECTION ID : 84 , SECTION SHAPE : P]
[SECTION SIZE] D:0.2191 tw:0.012

** MAX

ELEM COM	LC	PT	AXIAL	SHEAR-y	SHEAR-z	TORSION	MOMENT-y	MOMENT-z	LENGTH
121 AXL	INVSLU	1 I	715.7	33.9	14.9	0.7	7.1	17.3	1.00
98 SHY	INVSLU	1 I	354.1	35.3	81.4	0.2	40.6	18.4	1.00
132 SHZ	INVSLU	1 J	62.0	22.8	94.3	0.3	45.6	18.9	1.00
114 TOR	INVSLU	1 I	223.2	8.0	7.2	2.7	9.0	4.2	1.00
132 MTY	INVSLU	1 I	62.0	23.1	93.5	0.3	46.6	11.8	1.00
116 MTZ	INVSLU	1 J	510.9	18.0	54.2	1.3	13.1	23.5	1.00

** MIN

ELEM COM	LC	PT	AXIAL	SHEAR-y	SHEAR-z	TORSION	MOMENT-y	MOMENT-z	LENGTH
1210 AXL	INVSLU	1 I	-139.3	-21.7	-31.0	-0.1	-16.5	-10.4	1.00
118 SHY	INVSLU	1 I	270.1	-47.0	-34.2	-0.2	-20.8	-23.5	1.00
132 SHZ	INVSLU	1 I	-25.6	-36.3	-92.4	-0.2	-46.4	-17.4	1.00
130 TOR	INVSLV	1 I	161.1	-15.9	-72.1	-0.4	-36.4	-7.7	1.00
132 MTY	INVSLU	1 J	-25.6	-36.3	-91.7	-0.2	-47.3	-11.1	1.00
118 MTZ	INVSLU	1 I	270.1	-47.0	-34.2	-0.2	-20.8	-23.5	1.00

[SECTION NAME : 2UPN200 , SECTION ID : 85 , SECTION SHAPE : 2C]
[SECTION SIZE] H:0.2 B:0.075 tw:0.0085 tf:0.0115 C:0.012

** MAX

ELEM COM	LC	PT	AXIAL	SHEAR-y	SHEAR-z	TORSION	MOMENT-y	MOMENT-z	LENGTH
1198 AXL	INVSLU	1 J	647.1	0.7	0.4	-0.0	0.0	0.0	2.56
1190 SHY	INVSLU	1 J	125.7	0.9	0.4	0.0	0.0	0.0	2.60
1209 SHZ	INVSLU	1 J	175.4	0.3	0.4	0.0	0.0	0.0	2.56
1190 TOR	INVSLU	1 I	-492.5	-0.9	-0.4	0.0	0.0	0.0	2.60
1181 MTY	INVSLU	1 I	-1401.0	-0.2	-0.4	0.0	0.0	0.0	2.60
1181 MTZ	INVSLU	1 I	-1401.0	-0.2	-0.4	0.0	0.0	0.0	2.60

** MIN

ELEM COM	LC	PT	AXIAL	SHEAR-y	SHEAR-z	TORSION	MOMENT-y	MOMENT-z	LENGTH
1181 AXL	INVSLU	1 I	-1401.0	-0.2	-0.4	0.0	0.0	0.0	2.60
1190 SHY	INVSLU	1 I	-492.5	-0.9	-0.4	0.0	0.0	0.0	2.60
1209 SHZ	INVSLU	1 I	-479.3	-0.3	-0.4	0.0	0.0	0.0	2.56
1190 TOR	INVSLU	1 I	-492.5	-0.9	-0.4	0.0	0.0	0.0	2.60
1181 MTY	INVSLU	1 I	-1401.0	-0.2	-0.4	0.0	0.0	0.0	2.60
1181 MTZ	INVSLU	1 I	-1401.0	-0.2	-0.4	0.0	0.0	0.0	2.60

[SECTION NAME : A16s , SECTION ID : 94]

** MAX

ELEM COM	LC	PT	AXIAL	SHEAR-y	SHEAR-z	TORSION	MOMENT-y	MOMENT-z	LENGTH
838 AXL	INVSLU	1 J	3097.5	257.8	704.0	240.7	1983.3	-1371.0	2.00
838 SHY	INVSLV	1 I	2480.8	744.8	302.0	214.5	1517.6	2552.4	2.00
838 SHZ	INVSLU	1 I	2859.2	368.3	713.5	240.7	3315.4	-745.8	2.00
838 TOR	INVSLU	1 I	2859.2	368.3	713.5	240.7	3315.4	-745.8	2.00
838 MTY	INVSLU	1 I	2859.2	368.3	713.5	240.7	3315.4	-745.8	2.00
838 MTZ	INVSLV	1 I	2480.8	744.8	302.0	214.5	1517.6	2552.4	2.00

** MIN

ELEM COM	LC	PT	AXIAL	SHEAR-y	SHEAR-z	TORSION	MOMENT-y	MOMENT-z	LENGTH
838 AXL	INVSLU	1 I	-10794.8	-389.7	-862.4	-181.7	-3206.8	-13836.2	2.00
838 SHY	INVSLV	1 J	-9109.6	-901.9	-384.5	-360.5	-958.2	-15489.2	2.00
838 SHZ	INVSLU	1 I	-10794.8	-389.7	-862.4	-181.7	-3206.8	-13836.2	2.00
838 TOR	INVSLV	1 J	-9109.6	-901.9	-384.5	-360.5	-958.2	-15489.2	2.00
838 MTY	INVSLU	1 I	-10794.8	-389.7	-862.4	-181.7	-3206.8	-13836.2	2.00
838 MTZ	INVSLV	1 I	-9286.0	-822.2	-384.5	-360.5	-1475.5	-17080.0	2.00

[SECTION NAME : A17s , SECTION ID : 95]

** MAX

ELEM COM	LC	PT	AXIAL	SHEAR-y	SHEAR-z	TORSION	MOMENT-y	MOMENT-z	LENGTH
1169 AXL	INVSLU	1 J	2929.3	109.0	532.3	-1.3	799.0	-1806.2	2.40
1169 SHY	INVSLU	1 I	2492.7	553.0	256.7	205.3	1094.6	1281.4	2.40
1169 SHZ	INVSLU	1 I	2665.4	227.1	543.8	-1.3	2024.8	-1405.9	2.40
1169 TOR	INVSLV	1 I	2492.7	553.0	256.7	205.3	1094.6	1281.4	2.40
1169 MTY	INVSLU	1 I	2665.4	227.1	543.8	-1.3	2024.8	-1405.9	2.40
1169 MTZ	INVSLV	1 I	2492.7	553.0	256.7	205.3	1094.6	1281.4	2.40

** MIN

ELEM COM	LC	PT	AXIAL	SHEAR-y	SHEAR-z	TORSION	MOMENT-y	MOMENT-z	LENGTH
1169 AXL	INVSLU	1 I	-10132.1	-520.6	-425.8	-232.6	-2168.2	-13281.9	2.40
1169 SHY	INVSLV	1 J	-8744.5	-970.4	-256.3	-234.9	-981.6	-13409.4	2.40
1169 SHZ	INVSLU	1 J	-9938.3	-609.0	-425.9	-232.6	-1330.1	-11923.6	2.40
1169 TOR	INVSLV	1 J	-8744.5	-970.4	-256.3	-234.9	-981.6	-13409.4	2.40
1169 MTY	INVSLU	1 I	-10132.1	-520.6	-425.8	-232.6	-2168.2	-13281.9	2.40

Sovrapasso di ingresso - Ponte strallato - Relazione di calcolo

1169 MTZ INVSLV 1 I -8939.8 -885.5 -256.3 -234.9 -1245.7 -15495.4 2.40

[SECTION NAME : A18s , SECTION ID : 96]

** MAX

ELEM COM	LC	PT	AXIAL	SHEAR-y	SHEAR-z	TORSION	MOMENT-y	MOMENT-z	LENGTH	
75 AXL	INVSLV	1	J	2704.0	328.4	188.0	212.0	784.3	-532.0	2.40
75 SHY	INVSLV	1	I	2532.1	403.1	188.0	212.0	994.0	220.2	2.40
75 SHZ	INVSLV	1	I	2295.3	109.5	305.7	270.6	1355.6	-1788.3	2.40
75 TOR	INVSLV	1	I	2295.3	109.5	305.7	270.6	1355.6	-1788.3	2.40
75 MTY	INVSLV	1	I	2295.3	109.5	305.7	270.6	1355.6	-1788.3	2.40
75 MTZ	INVSLV	1	I	2532.1	403.1	188.0	212.0	994.0	220.2	2.40

** MIN

ELEM COM	LC	PT	AXIAL	SHEAR-y	SHEAR-z	TORSION	MOMENT-y	MOMENT-z	LENGTH	
75 AXL	INVSLV	1	I	-9254.9	-601.9	-578.7	-10.4	-1650.9	-11709.2	2.40
75 SHY	INVSLV	1	J	-8383.5	-979.3	-259.2	-174.6	-729.9	-11253.5	2.40
75 SHZ	INVSLV	1	I	-9254.9	-601.9	-578.7	-10.4	-1650.9	-11709.2	2.40
75 TOR	INVSLV	1	J	-8383.5	-979.3	-259.2	-174.6	-729.9	-11253.5	2.40
75 MTY	INVSLV	1	I	-9254.9	-601.9	-578.7	-10.4	-1650.9	-11709.2	2.40
75 MTZ	INVSLV	1	I	-8555.4	-904.6	-259.2	-174.6	-1110.6	-13393.4	2.40

[SECTION NAME : A19s , SECTION ID : 97]

** MAX

ELEM COM	LC	PT	AXIAL	SHEAR-y	SHEAR-z	TORSION	MOMENT-y	MOMENT-z	LENGTH	
91 AXL	INVSLV	1	J	2385.7	190.7	261.4	110.9	551.6	-974.3	2.40
91 SHY	INVSLV	1	I	2235.8	255.8	261.4	110.9	1006.5	-539.3	2.40
91 SHZ	INVSLV	1	I	1533.0	8.6	534.5	-10.4	1171.4	-1920.9	2.40
91 TOR	INVSLV	1	J	2385.7	190.7	261.4	110.9	551.6	-974.3	2.40
91 MTY	INVSLV	1	I	1533.0	8.6	534.5	-10.4	1171.4	-1920.9	2.40
91 MTZ	INVSLV	1	I	2235.8	255.8	261.4	110.9	1006.5	-539.3	2.40

** MIN

ELEM COM	LC	PT	AXIAL	SHEAR-y	SHEAR-z	TORSION	MOMENT-y	MOMENT-z	LENGTH	
91 AXL	INVSLV	1	I	-8064.4	-693.0	-317.6	-222.9	-1038.1	-10423.9	2.40
91 SHY	INVSLV	1	J	-7757.5	-978.2	-188.2	-157.1	-681.4	-9077.2	2.40
91 SHZ	INVSLV	1	J	-7915.9	-761.4	-317.8	-222.9	-495.7	-8676.4	2.40
91 TOR	INVSLV	1	J	-7915.9	-761.4	-317.8	-222.9	-495.7	-8676.4	2.40
91 MTY	INVSLV	1	I	-8064.4	-693.0	-317.6	-222.9	-1038.1	-10423.9	2.40
91 MTZ	INVSLV	1	I	-7907.4	-913.1	-188.2	-157.1	-960.4	-11250.8	2.40

[SECTION NAME : A16d , SECTION ID : 98]

** MAX

ELEM COM	LC	PT	AXIAL	SHEAR-y	SHEAR-z	TORSION	MOMENT-y	MOMENT-z	LENGTH	
854 AXL	INVSLV	1	J	3139.2	284.6	532.1	467.9	2063.3	-1435.0	2.00
854 SHY	INVSLV	1	I	2674.9	737.7	314.7	369.3	1481.6	2658.0	2.00
854 SHZ	INVSLV	1	I	2901.0	395.1	534.0	467.9	3029.8	-756.1	2.00
854 TOR	INVSLV	1	I	2901.0	395.1	534.0	467.9	3029.8	-756.1	2.00
854 MTY	INVSLV	1	I	2901.0	395.1	534.0	467.9	3029.8	-756.1	2.00
854 MTZ	INVSLV	1	I	2674.9	737.7	314.7	369.3	1481.6	2658.0	2.00

** MIN

ELEM COM	LC	PT	AXIAL	SHEAR-y	SHEAR-z	TORSION	MOMENT-y	MOMENT-z	LENGTH	
854 AXL	INVSLV	1	I	-10576.2	-380.0	-1015.8	-29.2	-3462.0	-14228.8	2.00
854 SHY	INVSLV	1	J	-8963.6	-904.2	-341.6	-184.5	-1046.9	-15685.4	2.00
854 SHZ	INVSLV	1	I	-10576.2	-380.0	-1015.8	-29.2	-3462.0	-14228.8	2.00
854 TOR	INVSLV	1	J	-8963.6	-904.2	-341.6	-184.5	-1046.9	-15685.4	2.00
854 MTY	INVSLV	1	I	-10576.2	-380.0	-1015.8	-29.2	-3462.0	-14228.8	2.00
854 MTZ	INVSLV	1	I	-9140.0	-824.5	-341.6	-184.5	-1510.8	-17278.0	2.00

[SECTION NAME : A17d , SECTION ID : 99]

** MAX

ELEM COM	LC	PT	AXIAL	SHEAR-y	SHEAR-z	TORSION	MOMENT-y	MOMENT-z	LENGTH	
1171 AXL	INVSLV	1	J	3123.1	121.8	626.6	-20.7	1035.3	-1786.6	2.40
1171 SHY	INVSLV	1	I	2802.1	563.5	340.3	181.6	1359.9	1423.7	2.40
1171 SHZ	INVSLV	1	I	2859.4	240.0	628.9	-20.7	2311.3	-1356.9	2.40
1171 TOR	INVSLV	1	I	2802.1	563.5	340.3	181.6	1359.9	1423.7	2.40
1171 MTY	INVSLV	1	I	2859.4	240.0	628.9	-20.7	2311.3	-1356.9	2.40
1171 MTZ	INVSLV	1	I	2802.1	563.5	340.3	181.6	1359.9	1423.7	2.40

** MIN

ELEM COM	LC	PT	AXIAL	SHEAR-y	SHEAR-z	TORSION	MOMENT-y	MOMENT-z	LENGTH	
1171 AXL	INVSLV	1	I	-10023.4	-529.0	-307.1	-357.4	-1827.7	-13287.5	2.40
1171 SHY	INVSLV	1	J	-8684.9	-979.6	-201.4	-282.4	-868.2	-13550.3	2.40
1171 SHZ	INVSLV	1	I	-10023.4	-529.0	-307.1	-357.4	-1827.7	-13287.5	2.40
1171 TOR	INVSLV	1	J	-9829.6	-617.4	-306.9	-357.4	-1251.8	-11909.8	2.40
1171 MTY	INVSLV	1	I	-10023.4	-529.0	-307.1	-357.4	-1827.7	-13287.5	2.40

Sovrapasso di ingresso - Ponte strallato - Relazione di calcolo

1171 MTZ INVSLV 1 I -8880.3 -894.7 -201.4 -282.4 -1009.5 -15668.9 2.40

[SECTION NAME : A18d , SECTION ID : 100]

** MAX

ELEM COM	LC	PT	AXIAL	SHEAR-y	SHEAR-z	TORSION	MOMENT-y	MOMENT-z	LENGTH	
1163 AXL	INVSLV	1	J	2851.3	340.1	192.4	167.9	863.2	-441.4	2.40
1163 SHY	INVSLV	1	I	2679.4	414.8	192.4	167.9	1069.9	350.1	2.40
1163 SHZ	INVSLU	1	J	2557.0	13.9	365.9	210.3	810.2	-1914.8	2.40
1163 TOR	INVSLU	1	J	2557.0	13.9	365.9	210.3	810.2	-1914.8	2.40
1163 MTY	INVSLU	1	I	2324.9	118.1	365.7	210.3	1495.3	-1764.0	2.40
1163 MTZ	INVSLV	1	I	2679.4	414.8	192.4	167.9	1069.9	350.1	2.40

** MIN

ELEM COM	LC	PT	AXIAL	SHEAR-y	SHEAR-z	TORSION	MOMENT-y	MOMENT-z	LENGTH	
1163 AXL	INVSLU	1	I	-9053.3	-627.9	-562.1	-32.7	-1556.5	-12163.9	2.40
1163 SHY	INVSLU	1	J	-8217.4	-998.6	-244.6	-173.4	-704.7	-11379.2	2.40
1163 SHZ	INVSLU	1	I	-9053.3	-627.9	-562.1	-32.7	-1556.5	-12163.9	2.40
1163 TOR	INVSLU	1	J	-8217.4	-998.6	-244.6	-173.4	-704.7	-11379.2	2.40
1163 MTY	INVSLU	1	I	-9053.3	-627.9	-562.1	-32.7	-1556.5	-12163.9	2.40
1163 MTZ	INVSLV	1	I	-8389.3	-923.9	-244.6	-173.4	-1036.7	-13576.6	2.40

[SECTION NAME : A19d , SECTION ID : 101]

** MAX

ELEM COM	LC	PT	AXIAL	SHEAR-y	SHEAR-z	TORSION	MOMENT-y	MOMENT-z	LENGTH	
87 AXL	INVSLV	1	J	2683.2	203.3	268.6	125.8	564.5	-937.9	2.40
87 SHY	INVSLV	1	I	2533.3	268.4	268.6	125.8	1058.8	-467.2	2.40
87 SHZ	INVSLU	1	I	1682.9	3.3	523.5	-24.1	1230.2	-1924.0	2.40
87 TOR	INVSLU	1	I	2533.3	268.4	268.6	125.8	1058.8	-467.2	2.40
87 MTY	INVSLU	1	I	1682.9	3.3	523.5	-24.1	1230.2	-1924.0	2.40
87 MTZ	INVSLV	1	I	2533.3	268.4	268.6	125.8	1058.8	-467.2	2.40

** MIN

ELEM COM	LC	PT	AXIAL	SHEAR-y	SHEAR-z	TORSION	MOMENT-y	MOMENT-z	LENGTH	
87 AXL	INVSLU	1	I	-7988.1	-699.1	-300.6	-268.7	-960.5	-10213.4	2.40
87 SHY	INVSLU	1	J	-7751.8	-989.8	-184.9	-199.0	-611.8	-9150.4	2.40
87 SHZ	INVSLU	1	I	-7988.1	-699.1	-300.6	-268.7	-960.5	-10213.4	2.40
87 TOR	INVSLU	1	J	-7839.7	-767.5	-300.4	-268.7	-452.7	-8524.5	2.40
87 MTY	INVSLU	1	I	-7988.1	-699.1	-300.6	-268.7	-960.5	-10213.4	2.40
87 MTZ	INVSLV	1	I	-7901.6	-924.7	-184.9	-199.0	-905.2	-11357.2	2.40

[SECTION NAME : Impalcato 30-30-30 , SECTION ID : 102]

** MAX

ELEM COM	LC	PT	AXIAL	SHEAR-y	SHEAR-z	TORSION	MOMENT-y	MOMENT-z	LENGTH	
1023 AXL	INVSLU	1	J	1250.1	903.1	684.8	3914.4	27916.1	-3989.0	0.65
1081 SHY	INVSLV	1	I	239.0	2420.4	-673.2	3521.7	-2068.9	13891.0	0.65
1080 SHZ	INVSLU	1	J	-1597.8	-418.9	4406.5	-423.4	-2310.2	19747.7	0.65
1081 TOR	INVSLU	1	I	-1518.8	1956.5	-936.2	7784.9	-2280.3	16739.2	0.65
1030 MTY	INVSLU	1	J	1164.8	818.0	1060.6	3633.3	29132.0	-4553.7	0.57
1080 MTZ	INVSLU	1	J	-1597.8	-418.9	4406.5	-423.4	-2310.2	19747.7	0.65

** MIN

ELEM COM	LC	PT	AXIAL	SHEAR-y	SHEAR-z	TORSION	MOMENT-y	MOMENT-z	LENGTH	
1073 AXL	INVSLV	1	I	-5067.9	-2048.8	408.4	-3185.7	-3792.6	-4487.7	0.64
1080 SHY	INVSLV	1	J	-5031.2	-2495.5	689.3	-3692.6	-8473.8	-6788.3	0.65
1081 SHZ	INVSLU	1	I	-4639.5	328.0	-4384.5	411.2	-26095.4	1120.2	0.65
1080 TOR	INVSLU	1	J	-4370.9	-2003.2	948.1	-7858.7	-26364.6	1642.8	0.65
1080 MTY	INVSLU	1	J	-4370.9	-2003.2	948.1	-7858.7	-26364.6	1642.8	0.65
1121 MTZ	INVSLU	1	I	-1620.8	-716.1	-1909.6	-4829.6	2711.6	-17611.5	0.64

[SECTION NAME : f-Impalcato 30-30-30 , SECTION ID : 103]

** MAX

ELEM COM	LC	PT	AXIAL	SHEAR-y	SHEAR-z	TORSION	MOMENT-y	MOMENT-z	LENGTH	
1021 AXL	INVSLU	1	J	1239.0	898.8	511.8	3797.7	26929.3	-3420.7	0.40
1084 SHY	INVSLV	1	I	194.7	2190.7	-557.3	3201.6	-863.2	9831.8	0.40
1077 SHZ	INVSLU	1	J	-1644.4	-317.4	4071.4	128.4	-742.1	16477.5	0.40
1084 TOR	INVSLU	1	I	-1543.5	1755.8	-808.5	6856.4	-733.9	13645.1	0.40
1029 MTY	INVSLU	1	J	1152.1	817.6	964.1	3780.0	29092.1	-4286.3	0.40
1077 MTZ	INVSLU	1	J	-1644.4	-317.4	4071.4	128.4	-742.1	16477.5	0.40

** MIN

ELEM COM	LC	PT	AXIAL	SHEAR-y	SHEAR-z	TORSION	MOMENT-y	MOMENT-z	LENGTH	
1077 AXL	INVSLV	1	I	-5067.4	-2269.2	545.0	-3365.2	-5939.5	-5486.0	0.40
1077 SHY	INVSLV	1	J	-5066.3	-2269.2	573.3	-3368.0	-6395.6	-5708.4	0.40
1084 SHZ	INVSLU	1	I	-4694.0	245.2	-4044.8	-132.4	-20493.9	146.0	0.40
1077 TOR	INVSLU	1	J	-4442.7	-1808.4	823.7	-6921.2	-20484.2	655.3	0.40
1084 MTY	INVSLU	1	I	-4694.0	245.2	-4044.8	-132.4	-20493.9	146.0	0.40

Sovrapasso di ingresso - Ponte strallato - Relazione di calcolo

1124 MTZ INVSLU 1 I -1608.2 -729.5 -1592.3 -4363.9 3221.1 -16410.1 0.40

REACTION FORCES & MOMENTS DEFAULT PRINTOUT.

Unit System : kN , m

Node	LC		FX	FY	FZ	MX	MY	MZ
497	INVSLU	Max	493.9	-242.0	6017.6	12048.8	6038.0	-480.8
		Min	128.6	-992.9	2240.8	3000.8	-1657.3	-1846.7
	INVSLV	Max	911.6	599.5	3094.5	16840.3	8100.3	567.1
		Min	-379.1	-1650.4	1947.1	-5664.8	-4106.6	-2557.9
	INVSLEP	Max	346.1	-239.8	4412.7	9075.0	4442.8	-459.7
		Min	123.0	-695.2	2454.9	2769.1	-1137.6	-1294.1
	INVSLEQ	Max	311.3	-607.9	2424.5	5914.7	1951.1	-1151.6
		Min	308.0	-614.4	2413.3	5914.1	1921.2	-1163.9
	INVSLEF	Max	217.5	-316.3	3719.1	6308.6	2944.3	-606.8
		Min	162.3	-429.3	2567.1	4186.5	485.0	-813.3
498	INVSLU	Max	-119.9	-222.1	5713.1	11260.6	2001.0	1358.6
		Min	-507.0	-1015.2	2013.1	2269.1	-5709.8	-882.4
	INVSLV	Max	309.8	409.7	2875.4	12944.5	3101.7	1919.5
		Min	-833.2	-1442.6	1711.4	-3352.1	-6414.9	-1407.5
	INVSLEP	Max	-117.9	-223.0	4186.6	8422.8	1438.1	967.9
		Min	-356.0	-712.3	2232.4	1954.7	-4169.8	-633.2
	INVSLEQ	Max	-301.7	-595.5	2198.6	4995.6	-1514.0	314.9
		Min	-303.8	-599.7	2187.9	4964.2	-1561.0	225.1
	INVSLEF	Max	-161.0	-314.5	3493.8	6083.2	-190.0	535.6
		Min	-229.4	-452.8	2345.6	3455.8	-2837.9	-204.0
1213	INVSLU	Max	354.1	-22.3	1691.9	0.0	0.0	0.0
		Min	36.9	-266.4	513.7	0.0	0.0	0.0
	INVSLV	Max	510.1	300.6	1911.2	0.0	0.0	0.0
		Min	-260.8	-481.7	-315.5	0.0	0.0	0.0
	INVSLEP	Max	254.1	-39.5	1216.7	0.0	0.0	0.0
		Min	27.2	-184.6	501.4	0.0	0.0	0.0
	INVSLEQ	Max	116.2	-70.7	748.6	0.0	0.0	0.0
		Min	115.5	-72.2	744.2	0.0	0.0	0.0
	INVSLEF	Max	184.4	-92.0	1013.5	0.0	0.0	0.0
		Min	96.4	-143.2	728.7	0.0	0.0	0.0
1214	INVSLU	Max	258.5	-28.3	1499.1	0.0	0.0	0.0
		Min	-52.4	-285.6	662.6	0.0	0.0	0.0
	INVSLV	Max	443.1	284.7	1766.4	0.0	0.0	0.0
		Min	-310.7	-493.7	-97.7	0.0	0.0	0.0
	INVSLEP	Max	185.2	-68.9	1075.8	0.0	0.0	0.0
		Min	-37.3	-197.4	718.0	0.0	0.0	0.0
	INVSLEQ	Max	61.8	-82.3	780.2	0.0	0.0	0.0
		Min	61.5	-84.1	775.3	0.0	0.0	0.0
	INVSLEF	Max	117.0	-118.0	974.1	0.0	0.0	0.0
		Min	31.8	-154.1	849.4	0.0	0.0	0.0
1215	INVSLU	Max	36.6	-27.1	1475.5	0.0	0.0	0.0
		Min	-267.0	-280.0	660.5	0.0	0.0	0.0
	INVSLV	Max	316.3	294.7	1786.1	0.0	0.0	0.0
		Min	-456.8	-500.8	-122.1	0.0	0.0	0.0
	INVSLEP	Max	26.5	-73.9	1057.8	0.0	0.0	0.0
		Min	-190.8	-193.2	736.3	0.0	0.0	0.0
	INVSLEQ	Max	-63.0	-80.4	775.8	0.0	0.0	0.0
		Min	-63.6	-82.2	770.7	0.0	0.0	0.0
	INVSLEF	Max	-39.8	-121.0	961.7	0.0	0.0	0.0
		Min	-122.3	-152.6	859.7	0.0	0.0	0.0
1216	INVSLU	Max	-51.5	-19.3	1654.0	0.0	0.0	0.0
		Min	-358.3	-262.3	540.0	0.0	0.0	0.0
	INVSLV	Max	279.0	301.1	2031.1	0.0	0.0	0.0
		Min	-534.9	-474.5	-449.1	0.0	0.0	0.0
	INVSLEP	Max	-38.9	-45.1	1187.0	0.0	0.0	0.0
		Min	-256.4	-181.5	521.1	0.0	0.0	0.0

Sovrapasso di ingresso - Ponte strallato - Relazione di calcolo

	INVSLEQP	Max	-116.3	-66.0	735.5	0.0	0.0	0.0
		Min	-117.3	-67.6	730.4	0.0	0.0	0.0
	INVSLEF	Max	-104.6	-93.3	995.0	0.0	0.0	0.0
		Min	-187.6	-133.2	736.4	0.0	0.0	0.0
1217	INVS LU	Max	-87.9	19.9	1772.3	0.0	0.0	0.0
		Min	-357.8	-185.9	601.4	0.0	0.0	0.0
	INVS LV	Max	274.1	312.9	2042.1	0.0	0.0	0.0
		Min	-554.0	-390.4	-331.5	0.0	0.0	0.0
	INVS LER	Max	-67.3	4.4	1284.3	0.0	0.0	0.0
		Min	-256.8	-126.7	565.0	0.0	0.0	0.0
	INVSLEQP	Max	-130.2	-21.8	821.0	0.0	0.0	0.0
		Min	-131.0	-23.1	817.9	0.0	0.0	0.0
	INVSLEF	Max	-125.0	-41.0	1056.5	0.0	0.0	0.0
		Min	-190.8	-78.8	776.6	0.0	0.0	0.0
1218	INVS LU	Max	-58.8	33.5	1554.7	0.0	0.0	0.0
		Min	-195.1	-121.6	792.5	0.0	0.0	0.0
	INVS LV	Max	213.4	278.1	1630.8	0.0	0.0	0.0
		Min	-368.6	-318.4	189.5	0.0	0.0	0.0
	INVS LER	Max	-49.4	-3.3	1128.9	0.0	0.0	0.0
		Min	-139.4	-80.9	843.8	0.0	0.0	0.0
	INVSLEQP	Max	-71.4	-6.9	874.4	0.0	0.0	0.0
		Min	-71.9	-7.8	871.2	0.0	0.0	0.0
	INVSLEF	Max	-77.5	-32.9	1031.6	0.0	0.0	0.0
		Min	-100.2	-51.7	924.6	0.0	0.0	0.0
1219	INVS LU	Max	175.6	32.2	1577.4	0.0	0.0	0.0
		Min	38.4	-128.4	794.9	0.0	0.0	0.0
	INVS LV	Max	351.5	272.6	1627.2	0.0	0.0	0.0
		Min	-207.6	-316.2	198.6	0.0	0.0	0.0
	INVS LER	Max	125.3	2.0	1146.3	0.0	0.0	0.0
		Min	28.2	-85.9	828.6	0.0	0.0	0.0
	INVSLEQP	Max	67.0	-8.8	879.6	0.0	0.0	0.0
		Min	66.6	-9.7	876.6	0.0	0.0	0.0
	INVSLEF	Max	94.0	-30.5	1042.3	0.0	0.0	0.0
		Min	67.9	-53.5	917.2	0.0	0.0	0.0
1220	INVS LU	Max	353.3	16.3	1798.8	0.0	0.0	0.0
		Min	67.3	-189.7	588.4	0.0	0.0	0.0
	INVS LV	Max	533.3	315.2	1975.7	0.0	0.0	0.0
		Min	-259.1	-401.9	-250.2	0.0	0.0	0.0
	INVS LER	Max	254.0	7.7	1305.7	0.0	0.0	0.0
		Min	51.2	-129.5	555.6	0.0	0.0	0.0
	INVSLEQP	Max	129.9	-27.2	835.2	0.0	0.0	0.0
		Min	129.3	-28.4	832.8	0.0	0.0	0.0
	INVSLEF	Max	188.2	-41.5	1070.8	0.0	0.0	0.0
		Min	118.0	-89.6	774.4	0.0	0.0	0.0
1221	INVS LU	Max	301.0	96.2	1859.0	0.0	0.0	0.0
		Min	74.7	-6.9	627.5	0.0	0.0	0.0
	INVS LV	Max	493.6	290.5	2004.9	0.0	0.0	0.0
		Min	-233.8	-201.4	-202.2	0.0	0.0	0.0
	INVS LER	Max	218.3	73.9	1361.4	0.0	0.0	0.0
		Min	58.0	1.1	576.6	0.0	0.0	0.0
	INVSLEQP	Max	128.2	52.4	897.8	0.0	0.0	0.0
		Min	128.1	51.8	897.6	0.0	0.0	0.0
	INVSLEF	Max	161.9	42.5	1096.4	0.0	0.0	0.0
		Min	120.5	23.6	791.9	0.0	0.0	0.0
1222	INVS LU	Max	116.0	145.2	1599.0	0.0	0.0	0.0
		Min	-17.3	70.4	882.0	0.0	0.0	0.0
	INVS LV	Max	204.7	272.7	1410.4	0.0	0.0	0.0
		Min	-140.1	-79.7	474.9	0.0	0.0	0.0
	INVS LER	Max	84.6	107.6	1175.9	0.0	0.0	0.0
		Min	-11.0	75.4	848.9	0.0	0.0	0.0
	INVSLEQP	Max	30.8	96.4	936.0	0.0	0.0	0.0
		Min	30.7	96.2	935.5	0.0	0.0	0.0
	INVSLEF	Max	58.4	96.7	1052.2	0.0	0.0	0.0

Sovrapasso di ingresso - Ponte strallato - Relazione di calcolo

		Min	12.5	88.5	927.9	0.0	0.0	0.0
1223	INVS LU	Max	9.9	149.7	1588.8	0.0	0.0	0.0
		Min	-125.5	72.7	893.2	0.0	0.0	0.0
	INVS LV	Max	135.8	273.4	1440.9	0.0	0.0	0.0
		Min	-210.6	-76.5	438.4	0.0	0.0	0.0
	INVS LER	Max	4.7	110.9	1167.6	0.0	0.0	0.0
		Min	-91.9	77.6	868.6	0.0	0.0	0.0
	INVS LEQP	Max	-36.9	98.2	930.4	0.0	0.0	0.0
		Min	-36.9	97.9	929.7	0.0	0.0	0.0
	INVS LEF	Max	-18.2	100.0	1046.6	0.0	0.0	0.0
		Min	-64.6	90.4	928.4	0.0	0.0	0.0
1224	INVS LU	Max	-108.5	92.4	1845.3	0.0	0.0	0.0
		Min	-311.4	-4.1	636.1	0.0	0.0	0.0
	INVS LV	Max	235.3	288.4	2012.3	0.0	0.0	0.0
		Min	-498.6	-189.8	-225.7	0.0	0.0	0.0
	INVS LER	Max	-82.7	71.0	1349.3	0.0	0.0	0.0
		Min	-225.7	3.0	582.4	0.0	0.0	0.0
	INVS LEQP	Max	-128.8	57.1	882.6	0.0	0.0	0.0
		Min	-129.0	56.7	881.8	0.0	0.0	0.0
	INVS LEF	Max	-124.0	45.9	1087.0	0.0	0.0	0.0
		Min	-163.7	28.8	788.1	0.0	0.0	0.0
1225	INVS LU	Max	-99.0	160.8	1868.0	0.0	0.0	0.0
		Min	-263.7	65.4	654.2	0.0	0.0	0.0
	INVS LV	Max	206.6	281.2	1992.0	0.0	0.0	0.0
		Min	-449.1	-92.9	-176.6	0.0	0.0	0.0
	INVS LER	Max	-78.9	120.5	1378.8	0.0	0.0	0.0
		Min	-194.3	65.1	582.0	0.0	0.0	0.0
	INVS LEQP	Max	-126.0	97.8	924.6	0.0	0.0	0.0
		Min	-126.5	97.7	923.0	0.0	0.0	0.0
	INVS LEF	Max	-102.4	99.3	1088.0	0.0	0.0	0.0
		Min	-136.6	81.9	775.4	0.0	0.0	0.0
1226	INVS LU	Max	53.1	172.2	1599.4	0.0	0.0	0.0
		Min	-139.8	82.9	915.0	0.0	0.0	0.0
	INVS LV	Max	139.6	276.6	1373.9	0.0	0.0	0.0
		Min	-198.3	-56.6	523.3	0.0	0.0	0.0
	INVS LER	Max	37.7	127.1	1189.7	0.0	0.0	0.0
		Min	-103.8	89.6	852.5	0.0	0.0	0.0
	INVS LEQP	Max	-31.6	108.7	969.8	0.0	0.0	0.0
		Min	-31.8	108.4	967.8	0.0	0.0	0.0
	INVS LEF	Max	5.5	115.7	1039.3	0.0	0.0	0.0
		Min	-65.8	102.0	897.6	0.0	0.0	0.0
1227	INVS LU	Max	140.7	164.4	1596.7	0.0	0.0	0.0
		Min	-52.8	82.0	877.7	0.0	0.0	0.0
	INVS LV	Max	197.1	275.9	1403.8	0.0	0.0	0.0
		Min	-141.3	-59.5	499.4	0.0	0.0	0.0
	INVS LER	Max	103.7	121.8	1188.4	0.0	0.0	0.0
		Min	-38.1	88.5	831.0	0.0	0.0	0.0
	INVS LEQP	Max	28.2	107.2	975.7	0.0	0.0	0.0
		Min	28.2	106.9	973.5	0.0	0.0	0.0
	INVS LEF	Max	65.4	111.5	1039.5	0.0	0.0	0.0
		Min	-6.0	100.7	900.0	0.0	0.0	0.0
1228	INVS LU	Max	258.4	144.6	1868.5	0.0	0.0	0.0
		Min	66.9	62.2	631.5	0.0	0.0	0.0
	INVS LV	Max	454.0	281.1	2021.1	0.0	0.0	0.0
		Min	-210.2	-102.0	-189.0	0.0	0.0	0.0
	INVS LER	Max	190.3	108.8	1381.3	0.0	0.0	0.0
		Min	55.1	61.2	565.2	0.0	0.0	0.0
	INVS LEQP	Max	127.2	94.0	940.9	0.0	0.0	0.0
		Min	126.8	93.7	938.6	0.0	0.0	0.0
	INVS LEF	Max	137.4	90.3	1092.5	0.0	0.0	0.0
		Min	103.3	76.8	784.7	0.0	0.0	0.0
1229	INVS LU	Max	281.4	182.9	1854.9	0.0	0.0	0.0

Sovrapasso di ingresso - Ponte strallato - Relazione di calcolo

		Min	55.9	73.4	630.6	0.0	0.0	0.0
	INVS LV	Max	483.1	279.8	2140.7	0.0	0.0	0.0
		Min	-225.2	-68.6	-297.9	0.0	0.0	0.0
	INVS LER	Max	210.1	137.1	1384.5	0.0	0.0	0.0
		Min	49.8	74.1	549.7	0.0	0.0	0.0
	INVS LEQP	Max	140.3	109.9	975.3	0.0	0.0	0.0
		Min	139.4	109.6	970.5	0.0	0.0	0.0
	INVS LEF	Max	145.6	113.8	1075.9	0.0	0.0	0.0
		Min	99.6	89.5	769.4	0.0	0.0	0.0
1230	INVS LU	Max	176.7	170.8	1639.6	0.0	0.0	0.0
		Min	-72.4	85.8	842.2	0.0	0.0	0.0
	INVS LV	Max	218.2	278.8	1549.0	0.0	0.0	0.0
		Min	-152.2	-55.1	370.6	0.0	0.0	0.0
	INVS LER	Max	130.8	126.2	1234.6	0.0	0.0	0.0
		Min	-51.7	92.2	789.5	0.0	0.0	0.0
	INVS LEQP	Max	34.6	110.9	1015.2	0.0	0.0	0.0
		Min	34.6	110.6	1010.3	0.0	0.0	0.0
	INVS LEF	Max	80.5	115.7	1040.1	0.0	0.0	0.0
		Min	-11.4	104.4	856.0	0.0	0.0	0.0
1231	INVS LU	Max	81.7	178.8	1648.7	0.0	0.0	0.0
		Min	-165.5	85.9	848.6	0.0	0.0	0.0
	INVS LV	Max	155.4	279.5	1535.3	0.0	0.0	0.0
		Min	-216.6	-52.3	378.3	0.0	0.0	0.0
	INVS LER	Max	57.6	132.0	1240.5	0.0	0.0	0.0
		Min	-123.5	92.8	798.5	0.0	0.0	0.0
	INVS LEQP	Max	-34.7	112.3	1009.3	0.0	0.0	0.0
		Min	-35.2	111.9	1004.6	0.0	0.0	0.0
	INVS LEF	Max	16.3	120.0	1043.7	0.0	0.0	0.0
		Min	-74.9	105.4	853.6	0.0	0.0	0.0
1232	INVS LU	Max	-83.0	198.7	1868.8	0.0	0.0	0.0
		Min	-268.0	76.8	667.3	0.0	0.0	0.0
	INVS LV	Max	216.6	279.6	2059.5	0.0	0.0	0.0
		Min	-467.2	-60.0	-233.6	0.0	0.0	0.0
	INVS LER	Max	-69.3	148.4	1392.7	0.0	0.0	0.0
		Min	-200.5	78.1	576.5	0.0	0.0	0.0
	INVS LEQP	Max	-136.2	113.0	958.9	0.0	0.0	0.0
		Min	-137.4	112.9	954.9	0.0	0.0	0.0
	INVS LEF	Max	-95.3	122.4	1077.2	0.0	0.0	0.0
		Min	-138.4	93.5	754.1	0.0	0.0	0.0
1233	INVS LU	Max	-80.0	194.6	1871.6	0.0	0.0	0.0
		Min	-298.6	76.0	677.6	0.0	0.0	0.0
	INVS LV	Max	232.5	261.1	2130.8	0.0	0.0	0.0
		Min	-508.6	-45.7	-300.3	0.0	0.0	0.0
	INVS LER	Max	-69.7	145.2	1408.3	0.0	0.0	0.0
		Min	-225.3	77.8	569.2	0.0	0.0	0.0
	INVS LEQP	Max	-153.4	110.5	990.4	0.0	0.0	0.0
		Min	-155.0	110.4	983.9	0.0	0.0	0.0
	INVS LEF	Max	-99.2	120.8	1064.0	0.0	0.0	0.0
		Min	-152.8	92.2	729.9	0.0	0.0	0.0
1234	INVS LU	Max	72.2	160.7	1742.0	0.0	0.0	0.0
		Min	-203.6	79.1	777.2	0.0	0.0	0.0
	INVS LV	Max	181.1	263.3	1873.5	0.0	0.0	0.0
		Min	-278.6	-54.1	50.4	0.0	0.0	0.0
	INVS LER	Max	48.2	118.5	1320.5	0.0	0.0	0.0
		Min	-152.9	86.1	708.6	0.0	0.0	0.0
	INVS LEQP	Max	-56.5	102.9	1045.3	0.0	0.0	0.0
		Min	-57.3	102.6	1038.0	0.0	0.0	0.0
	INVS LEF	Max	2.6	109.2	1046.9	0.0	0.0	0.0
		Min	-93.4	97.7	797.3	0.0	0.0	0.0
1235	INVS LU	Max	225.5	155.0	1725.4	0.0	0.0	0.0
		Min	-55.3	77.1	780.5	0.0	0.0	0.0
	INVS LV	Max	287.7	262.8	1901.4	0.0	0.0	0.0
		Min	-177.5	-56.9	28.5	0.0	0.0	0.0

Sovrapasso di ingresso - Ponte strallato - Relazione di calcolo

	INVSLEP	Max	167.9	115.6	1309.0	0.0	0.0	0.0
		Min	-36.9	84.2	711.5	0.0	0.0	0.0
	INVSLEQP	Max	60.2	101.5	1051.1	0.0	0.0	0.0
		Min	59.9	101.2	1043.6	0.0	0.0	0.0
	INVSLEF	Max	105.1	106.0	1039.1	0.0	0.0	0.0
		Min	7.2	96.1	799.7	0.0	0.0	0.0
1236	INVSLEP	Max	322.3	180.6	1845.0	0.0	0.0	0.0
		Min	56.4	73.4	627.1	0.0	0.0	0.0
	INVSLEP	Max	535.6	262.3	2276.6	0.0	0.0	0.0
		Min	-246.4	-54.3	-429.3	0.0	0.0	0.0
	INVSLEP	Max	242.2	135.2	1390.6	0.0	0.0	0.0
		Min	52.4	74.6	532.5	0.0	0.0	0.0
	INVSLEQP	Max	160.4	107.8	1006.7	0.0	0.0	0.0
		Min	159.1	107.6	999.4	0.0	0.0	0.0
	INVSLEF	Max	165.6	113.1	1057.0	0.0	0.0	0.0
		Min	106.7	88.8	750.6	0.0	0.0	0.0

SUMMATION OF REACTION FORCES

LC	SUM-FX	SUM-FY	SUM-FZ
-----	-----	-----	-----

TRUSS ELEMENT FORCES DEFAULT PRINTOUT

Unit System : kN , m

ELEM	MAT	SEC	LC	FORCE-I	FORCE-J				
6	8	59	INVSLEP	Max	1224.2	1229.8			
				Min	181.7	189.2			
			INVSLEP	Max	895.9	901.5			
				Min	334.0	339.6			
			INVSLEP	Max	905.6	911.2			
				Min	219.7	225.3			
			INVSLEQP	Max	855.2	860.8			
				Min	849.4	855.0			
			INVSLEF	Max	702.0	707.6			
				Min	321.2	326.8			
			7	8	59	INVSLEP	Max	1120.5	1129.3
							Min	309.1	318.2
INVSLEP	Max	772.2				778.9			
	Min	209.8				216.6			
INVSLEP	Max	862.2				869.0			
	Min	261.6				268.4			
INVSLEQP	Max	572.8				579.5			
	Min	568.3				575.0			
INVSLEF	Max	655.0				661.7			
	Min	319.4				326.2			
8	8	59				INVSLEP	Max	932.6	942.6
							Min	263.4	270.8
			INVSLEP	Max	600.1	607.4			
				Min	51.6	59.0			
			INVSLEP	Max	676.4	683.7			
				Min	190.1	197.5			
			INVSLEQP	Max	242.9	250.2			
				Min	237.9	245.3			
			INVSLEF	Max	487.8	495.1			
				Min	215.3	222.6			
			9	8	59	INVSLEP	Max	777.0	787.8
							Min	259.1	269.9
INVSLEP	Max	546.5				554.5			
	Min	48.0				55.9			
INVSLEP	Max	565.8				573.8			
	Min	175.8				183.8			
INVSLEQP	Max	232.1				240.0			
	Min	225.5				233.4			
INVSLEF	Max	403.1				411.1			
	Min	193.9				201.9			
10	8	59				INVSLEP	Max	606.5	615.1
							Min	135.1	146.7
			INVSLEP	Max	473.7	482.2			
				Min	38.9	47.5			
			INVSLEP	Max	400.3	408.9			
				Min	94.2	102.8			
			INVSLEQP	Max	197.2	205.7			

Sovrapasso di ingresso - Ponte strallato - Relazione di calcolo

				Min	188.1	196.7
			INVSLEF	Max	269.8	278.3
				Min	116.9	125.5
11	8	59	INVS LU	Max	666.7	675.9
				Min	160.9	173.4
			INVS LV	Max	617.2	626.4
				Min	221.3	230.5
			INVS LER	Max	442.2	451.4
				Min	176.1	185.4
			INVS LEQP	Max	554.9	564.1
				Min	543.1	552.3
			INVS LEF	Max	338.8	348.0
				Min	208.1	217.4
12	8	59	INVS LU	Max	865.7	875.5
				Min	82.3	95.5
			INVS LV	Max	801.1	810.9
				Min	387.8	397.6
			INVS LER	Max	584.2	594.1
				Min	179.5	189.4
			INVS LEQP	Max	925.8	935.6
				Min	911.0	920.9
			INVS LEF	Max	471.5	481.3
				Min	263.7	273.6
14	8	59	INVS LU	Max	1204.4	1209.7
				Min	143.2	150.4
			INVS LV	Max	878.7	884.0
				Min	308.0	313.3
			INVS LER	Max	895.9	901.2
				Min	190.2	195.5
			INVS LEQP	Max	831.8	837.1
				Min	826.2	831.5
			INVS LEF	Max	689.3	694.6
				Min	300.0	305.3
15	8	59	INVS LU	Max	1107.4	1115.8
				Min	277.9	286.4
			INVS LV	Max	756.3	762.5
				Min	186.9	193.2
			INVS LER	Max	850.1	856.3
				Min	236.3	242.5
			INVS LEQP	Max	545.0	551.3
				Min	540.9	547.2
			INVS LEF	Max	640.9	647.2
				Min	299.3	305.6
16	8	59	INVS LU	Max	927.7	936.8
				Min	241.5	248.2
			INVS LV	Max	587.2	593.9
				Min	35.9	42.7
			INVS LER	Max	671.1	677.9
				Min	180.1	186.9
			INVS LEQP	Max	226.3	233.0
				Min	221.8	228.6
			INVS LEF	Max	482.8	489.5
				Min	207.0	213.7
17	8	59	INVS LU	Max	766.8	776.6
				Min	257.1	266.9
			INVS LV	Max	531.4	538.7
				Min	39.8	47.0
			INVS LER	Max	557.2	564.4
				Min	172.9	180.1
			INVS LEQP	Max	219.1	226.3
				Min	212.9	220.2
			INVS LEF	Max	397.9	405.1
				Min	189.0	196.2
18	8	59	INVS LU	Max	594.3	602.1
				Min	129.6	140.1
			INVS LV	Max	460.1	467.8
				Min	33.4	41.2
			INVS LER	Max	389.2	397.0
				Min	88.7	96.5
			INVS LEQP	Max	183.4	191.2
				Min	174.8	182.6
			INVS LEF	Max	261.7	269.4
				Min	110.5	118.2
19	8	59	INVS LU	Max	655.4	663.7
				Min	155.2	166.5
			INVS LV	Max	607.1	615.4
				Min	217.0	225.3
			INVS LER	Max	430.9	439.2
				Min	170.6	179.0
			INVS LEQP	Max	543.1	551.5
				Min	531.9	540.2
			INVS LEF	Max	330.1	338.4
				Min	201.7	210.0
20	8	59	INVS LU	Max	858.1	866.9
				Min	80.6	92.5
			INVS LV	Max	783.6	792.5
				Min	396.9	405.8
			INVS LER	Max	575.1	584.0
				Min	177.1	186.0
			INVS LEQP	Max	916.7	925.5
				Min	902.7	911.5

Sovrapasso di ingresso - Ponte strallato - Relazione di calcolo

			INVSLEF	Max	464.5	473.4
				Min	260.2	269.1
1710	5	11	INVS LU	Max	1085.7	1085.5
				Min	898.4	898.1
			INVS LV	Max	995.9	995.7
				Min	991.4	991.2
			INVS LER	Max	1069.9	1069.7
				Min	913.1	912.9
			INVS LEQP	Max	2028.0	2027.8
				Min	1951.4	1951.2
			INVS LEF	Max	1031.3	1031.1
				Min	951.7	951.5
1714	5	11	INVS LU	Max	1085.7	1085.5
				Min	898.3	898.0
			INVS LV	Max	995.8	995.6
				Min	991.5	991.3
			INVS LER	Max	1069.8	1069.6
				Min	913.1	912.9
			INVS LEQP	Max	2028.1	2027.9
				Min	1951.5	1951.3
			INVS LEF	Max	1031.3	1031.1
				Min	951.6	951.4
1718	5	11	INVS LU	Max	1084.2	1083.9
				Min	895.1	894.9
			INVS LV	Max	1006.7	1006.5
				Min	967.6	967.4
			INVS LER	Max	1070.3	1070.1
				Min	910.6	910.4
			INVS LEQP	Max	2017.1	2016.9
				Min	1940.9	1940.7
			INVS LEF	Max	1031.8	1031.6
				Min	949.1	948.9